

**RAILTEL CORPORATION OF INDIA LIMITED
(A Govt. of India Undertaking)
(Ministry of Railways)**

TENDER DOCUMENT

FOR

Excavation of Trenches and laying of OFC through ducts, testing, commissioning and maintenance of OFC in the sections of 01 (One) Block (Porbandar) of Porbandar District of Gujarat State by RaiTel on behalf of BBNL.

**Tender No. RaiTel /Tender/OT/WR/NOFN/ 2017-18/52
Date: 19/03/2018**

**Tender Copy No.
Sold to:**

.....
.....
.....
.....
.....

RAILTEL
A Government of India

INDEX SHEET

CHAPTER NO.	SUBJECT	PAGE NO.
1.	PREAMBLE	4-10
2.	SCHEDULE OF RATES	11-15
3.	INSTRUCTIONS TO TENDERERS AND CONDITIONS OF TENDERING	16-35
4.	GENERAL CONDITION OF CONTRACT	36-68
5.	SPECIAL CONDITIONS OF CONTRACT	69-89
6.	FORMS OF TENDERS, ETC	90-105
7.	TECHNICAL SPECIFICATION AND INSTRUCTIONS FOR TRENCHING , JOINTING AND TERMINATION OF FIBER OPTIC CABLE & DRAWINGS	106-166
8.	DRAWINGS	167-173

RAILTEL

A Government of India
Undertaking

TENDER NOTICE

No. RailTel /Tender/OT/WR/NOFN/2017-18/52

Date 19.03.2018

RailTel Corporation of India Ltd, Office No. 02, 2nd Floor, 4-D Square Mall, Opposite of Vishwakarma Govt. Engg College, Visat-Gandhinagar Highway, Motera, Ahmedabad-380005, invites sealed open tenders from the established and reliable contractors with proven experience for the following works: -

Excavation of Trenches and laying of OFC through ducts, testing, commissioning and maintenance of OFC in the sections of 01 (One) Block (Porbandar) of Porbandar District of Gujarat State by RailTel on behalf of BBNL.

Appx. Estimated Cost:- Rs. 2,53,37,840 /-(Rupees Two Crore Fifty Three Lakh Thirty Seven Thousands Eight Hundred & Forty Only.)

EMD:- Rs. 2,90,770/-(Rupees Two Lakhs Ninety Thousand Seven Hundred & Seventy only)

a)	Sale of Tender Documents	From 19.03.2018
b)	Pre-bid conference	15:00 hrs of 28.03.2018
c)	Closing of sale of Tender Documents	up to 12:00 Hrs. 09.04.2018
d)	Receipt of tender documents.	up to 15:00 Hrs. 09.04.2018
e)	Opening of tender documents.	at 15:30 Hrs. 09.04.2018
f)	Validity of offer	90 days from the date of opening of tender.
g)	Completion period	3 months from the date of issue of LOA of tender.
h)	Address for availability of tender document	General Manager-NOFN, RailTel Corporation of India Ltd., Office no.02, 2 nd Floor, 4-D Square Mall, Opposite of Vishwakarma Govt. Engg College, Visat-Gandhinagar Highway, Motera, Ahmedabad-380005
	Tender Opening Venue	
i)	Web address for availability of tender document	www.railtelindia.com
j)	Cost of Tender document by hand	Rs. 11,200.00
k)	Cost of Tender document if required by post	Rs. 11,760.00
l)	If the tender document is downloaded from the website then the cost of tender document as stated above have to be submitted along with the offer in the form of Bank Draft in favour of NOFN EXPENDITURE CURRENT ACCOUNT WR payable at Mumbai.	

MSE/NSIC units shall be exempted from submission of cost of tender document & EMD as per para 3.5.8 of chapter-3.

“The envelop must bear the SOR:, Tender No:, Schedule for Blocks (.....,,) & date of closing:”

The offers shall be opened on above said date in the presence of those bidders who choose to be present. In case the date of opening happens to be a holiday, the tender will be received and opened at the same time on the next working day.

Further information is available at RailTel’s website www.railtelindia.com or from the office of Executive Director- RailTel /Mumbai.

**General Manager/NOFN
For RailTel Corporation of India Limited, Ahmedabad**

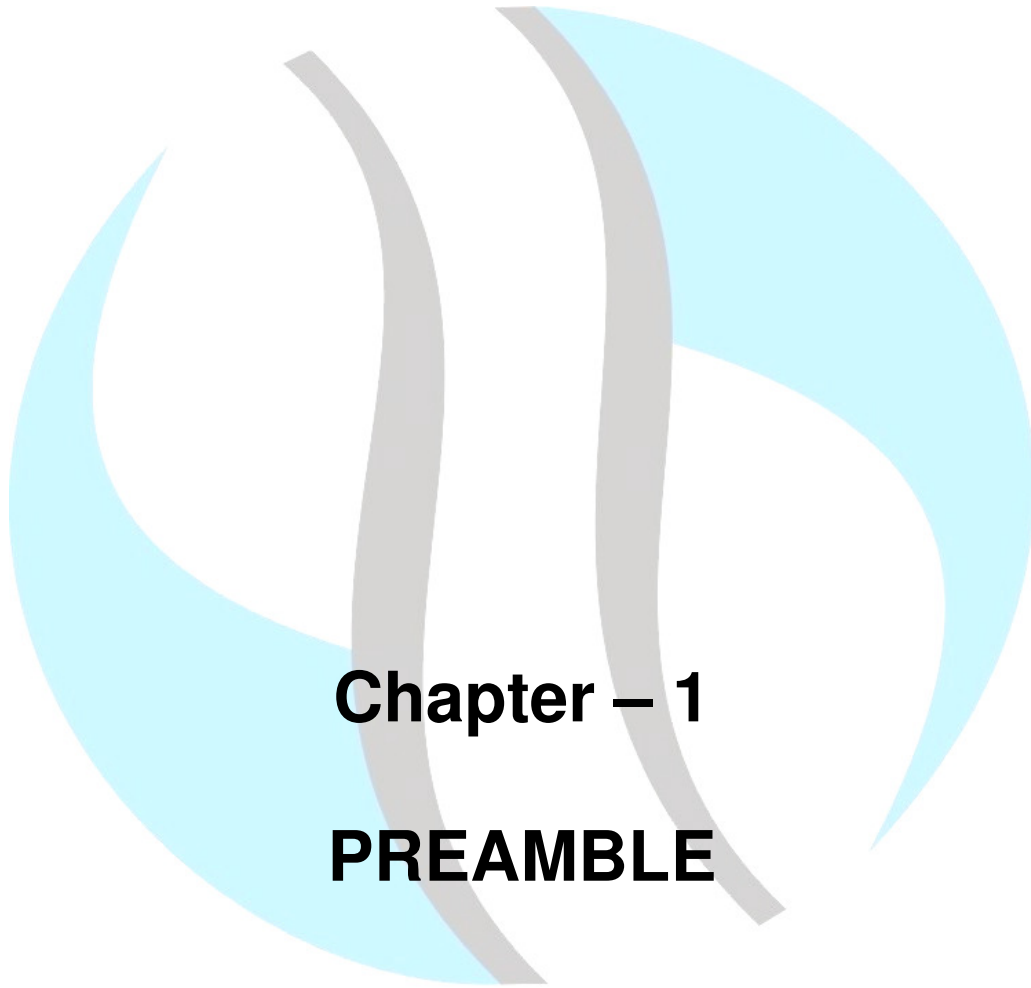

Chapter – 1

PREAMBLE

रेलटेल
RAILTEL

A Government of India
Undertaking

Preamble

Index

- 1.1 Scope of work
- 1.2 Tender Bid
- 1.3 Qualifying Criteria
- 1.4 Last date of Submission
- 1.5 Date of Opening of Tender
- 1.6 RailTel's right
- 1.7 Work Load
- 1.8 Validity of Offer
- 1.9 Completion Period of Work
- 1.10 The List of Address to which correspondence and documents relating to the Contract should be sent
- 1.11 Earnest Money
- 1.12 Security Deposit
- 1.13 Performance Bank Guarantee
- 1.14 Specifications
- 1.15 Schedule of Requirement
- 1.16 Work to be done by RailTel
- 1.17 Materials to be supplied by RailTel
- 1.18 Materials to be supplied by Contractor
- 1.19 Submission
- 1.20 Warranty Support

Preamble

Tender No. RailTel /Tender/OT/WR/NOFN/2017-18/52

1.0 Name of work: Excavation of Trenches and laying of OFC through ducts, testing, commissioning and maintenance of OFC in the sections of 01 (One) Block (Porbandar) of Porbandar District of Gujarat State by RailTel on behalf of BBNL

1.1 Scope of work:

The Engineering instructions spelt out in this tender document deal with the methods to be adopted for underground Optical Fiber Cable laying in PLB HDPE ducts and inter connection of the existing Optical Fiber Cables with the newly laid OF cables and termination of OF cables for National Optical Fiber Network.

The broad responsibility of the contractor under the scope of work for this tender shall be as under:

- i) Trenching and laying of HDPE Duct in all type of soils, Bridges/Culverts/Nallah, Road/Rail crossing etc. & protective works as per technical specifications.
- ii) Back filling and dressing of the excavated trenches according to technical specifications.
- iii) Blowing/puling of Optical Fiber Cable with proper tools and accessories as per Technical specifications.
- iv) Installation of Jointing Chambers & Route/Joint Indicators as per technical specification.
- v) Splicing of fibers in Joint closures and FTB/FDMS and tapping required no. of fibers from existing joint enclosures or making new joints with installation of new joint enclosures in run through OFC of BSNL/PGCIL/RailTel and exposing the existing cable by trenching & digging.
- vi) End to end Testing & Submission of test results, route diagrams & videography of route.
- vii) Getting the necessary permission for ROW and other permissions to execute the work.

1.2 Tender Bid

Tender bid shall be submitted in single covers as detailed in para no. 3.6.6 of tender document.

Pre- bid conference for this tender will be held on date, time and venue as given below:-

Last date of submission of points for clarification: 27.03.2018

Pre- bid conference:

Date: 28.03.2018

Time: 15:00 hrs

Venue: General Manager-NOFN,
RailTel Corporation of India Ltd., Office no.02, 2nd Floor,
4-D Square Mall, Opposite of Vishwakarma Govt. Engg College,
Visat- Gandhinagar Highway, Motera, Ahmedabad-380005

It is solicited that the written queries/clarifications may be sent to the RailTel's office latest by the date as indicated above through e-mail to sumitmishra@railtelindia.com with copy to s.mahobiya@railtelindia.com (in word format) & hard copy by post. All relevant clarifications sought will be addressed during the pre-bid meeting.

1.3. Qualifying Criteria

For qualifying in the tender, the tenderer shall be required to meet the eligibility requirements as given in Para 3.16 of tender document.

1.4 Last date of Submission

The tender shall be received up to **15:00 hrs on** 09.04.2018 at the office of General Manager-NOFN, RailTel Corporation of India Ltd., Office no.02, 2nd Floor, 4-D Square Mall, Opposite of Vishwakarma Govt. Engg College, Visat- Gandhinagar Highway, Motera, Ahmedabad-380005.

1.5 Date of Opening of Tender

The tenders will be opened at **15:30 hrs on** 09.04.2018 at the same address as mentioned in Para 1.10.

1.6 RailTel reserves the right:-

- a) To verify, if so desired, the correctness of documentary evidence furnished by the tenderer.
- b) To verify the successful operation and performance of qualifying projects and tenderer shall arrange permission for the same.
- c) To carry out capability assessment of the bidder(s) including referral to in-house information.
- d) RailTel shall not be responsible for any delay in the receipt of tenders and reserves the right to accept/reject any or all tenders.

RAILTEL
A Government of India
Undertaking

1.7 Work Load

The tenderer to submit the present work load of the telecom contracts in hand as per the format (Form No 9). The performance of the tenderer with regard to satisfactory execution of more than one contract simultaneously in the past shall be taken into account.

1.8 Validity of Offer

The tenderer shall keep the offer open for **90 days** from the date of opening of tender. Within that period, the tenderer can not withdraw his offer. This period can be extended further, if required, by mutual agreement from time to time. Any contravention of the above condition will make the tenderer liable for forfeiture of his Earnest Money.

1.9 Completion Period of Work:

The work to be executed and completed within 3 months from the date of issue of "Letter of Acceptance" of the tender.

1.10 The List of Address to which correspondence and documents relating to the Contract should be sent:

General Manager-NOFN, RailTel Corporation of India Ltd., Office no.02, 2nd Floor, 4-D Square Mall, Opposite of Vishwakarma Govt. Engg College, Visat-Gandhinagar Highway, Motera, Ahmedabad-380005.

1.11 Earnest Money

Tenderer shall deposit an Earnest Money of amount as mentioned below in a manner prescribed in Para 3.5 of tender document.

S N O	Tender No.	Name of District	EMD in Rs.
1	RailTel/Tender/OT/WR/NOFN/ 2017-18/52	Porbandar	2,90,770/-

1.12 Security Deposit

Security deposit shall be 5% of the contract value as detailed in Para 4.16 of tender document.

1.13 Performance Bank Guarantee

Performance Bank Guarantee shall be 5% of the contract value for successful completion of the work as detailed in para 3.17 of tender document.

In case of AMC, the tenderer is also required to submit PBG of 10% value of the annual maintenance charges towards fulfillment of obligation for the maintenance support as detailed in para 3.17 of tender document.

**A Government of India
Undertaking**

1.14 Specifications

Reference of specifications of the important equipments and materials required for execution of the contract is given in the Technical Specification (of tender document). The work shall be executed in compliance with all the technical requirements given therein.

The work shall be carried out as per Engineering Instructions issued by BBNL. However supplementary Engineering Instructions to BBNL's Engineering Instructions need to be followed in case of conflict with BBNL's Engineering Instructions. Both are enclosed at chapter 7 under technical specification.

Drawings are indicative. In case of any mismatch or confusion between drawings and technical specifications, technical specifications shall be final. Drawings are enclosed at Chapter 8.

1.15 Schedule of Requirement

The various items to be supplied and execution of the work by the tenderer for the section are indicated in Schedule of Requirement as in chapter 2 of this tender document. Payment of supplied items shall be done along with the payment of execution after the measurement. The tenderer is advised to quote single percentage at Par/ above/below of the RailTel's total estimated cost of schedule of work.

1.16 Work to be done by RailTel

- i. Availability of Equipment room for termination of OFC.
- ii. RailTel shall facilitate requisite letters etc. for ROW & other permissions as required. The contractor shall get the necessary permission etc. as required.

1.17 Materials to be supplied by RailTel

- i) O.F Cable.
- ii) Joint Closures.
- iii) Splitters
- iv) FTB/FDMS, pigtailed & patch cords etc.
- v) HDPE Duct

Contractor shall take the above materials at his own cost from the nominated store of RailTel and keep the account of materials provided by RailTel for execution of work and test all fibers of OFC & any defect shall be brought in to the notice of Engineer-in-charge.

Contractor shall return unused balance quantity to nominated store of RailTel in good condition at his own cost. The materials which are unusable (small pieces of Ducts & OFCs up to approx 10 mtrs) shall not be required to be returned however account of such unusable materials shall be given by the contractor & certified by the engineer of RailTel. Decision of engineer-in-charge shall be binding on the contractor.

Unused cable of length more than 70 mtrs will be wrapped in drums and deposited in the store. Rest of the empty drums shall be the property of the contractor. Reconciliation of materials shall be signed jointly by the contractor and RailTel's engineer.

1.18 Materials to be supplied by Contractor

- i) All type of Protection materials.
- ii) Joint Chambers
- iii) Man holes
- iv) Route Indicators
- v) Other items to meet end objective.

Contractor shall supply & install the materials as mentioned above. The left over materials if any shall be the property of the contractor. The payment shall be done to the contractor as per actual installation at the site.

Tenderer's special attention is invited to the fact that RailTel shall supply material as per Para 1.17. All other materials including the materials not specifically covered in the Schedule of Requirement but required to achieve the end objective are required to be supplied by the contractor.

1.19 Submission:

The tenderer shall submit all the required information in the relevant forms attached to this document and suitably numbering each page of the bid documents with a content list indicating availability of various documents with their serial numbers. In the absence of numbering of pages and the content list, there is a likelihood of any important document going unnoticed for which the tenderer shall be solely responsible.

1.20 Warranty Support

The tenderer should submit their strategy for providing maintenance support during maintenance, warranty and post warranty as per Para 5.29 and 5.15 of tender document.



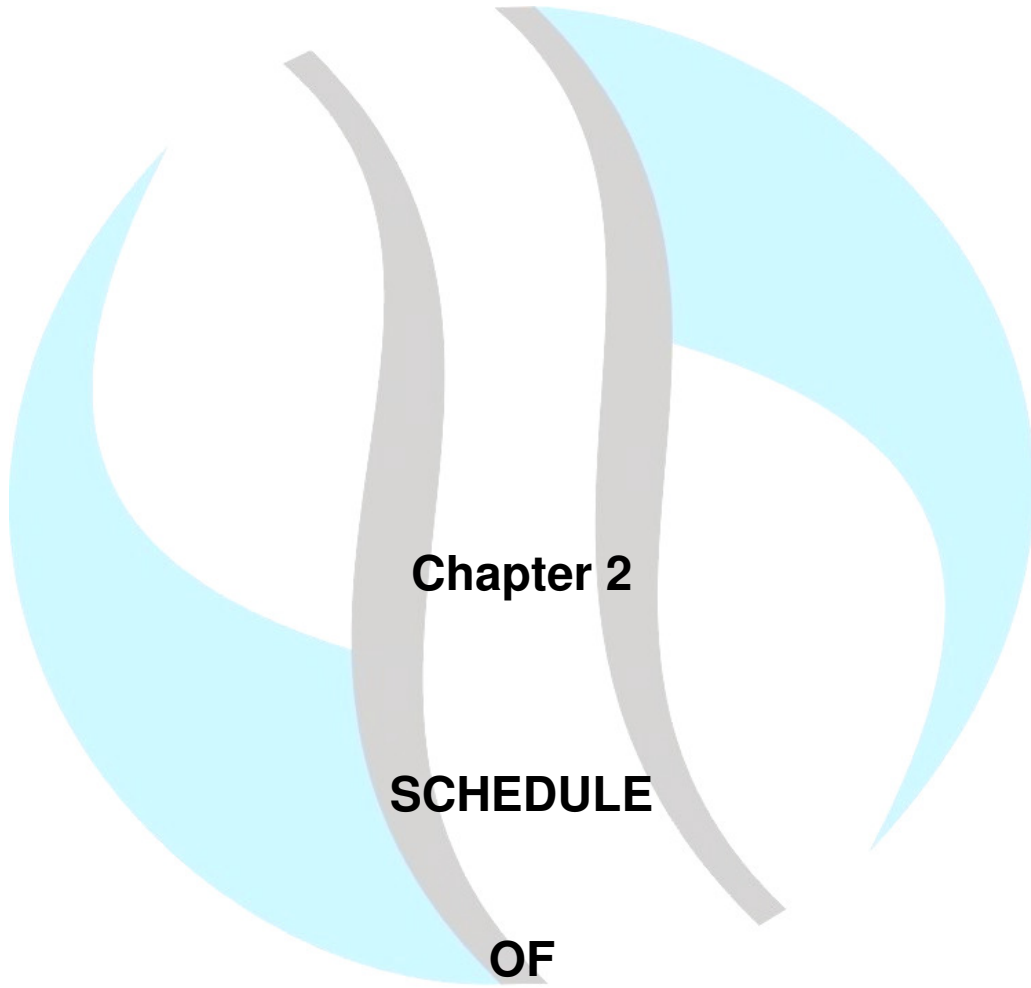

Chapter 2

SCHEDULE

OF

REQUIREMENTS

रेलटेल
RAILTEL

**A Government of India
Undertaking**

SCHEDULE OF WORK (Porbandar)

Block:Porbandar				District: Porbandar	
Total RKM: Approx. 60.319 Km					
SN	Description	Unit	Total Qty	Rate(Rs)	Amount (Rs)
				In figures	In figures
A	Supply				
1	Supply of GI pipe as per specification	Mtr	4309	331.75	1429510.75
2	Supply of DWC pipe as per specification	Mtr	35522	69.94	2484408.68
3	Supply of Flexible conduit pipe as per specification	Mtr	0	45.51	0.00
B	RailTel's Execution				
1	Excavation of trenches upto a depth of 1.65 m in all type of soil, culverts/bridges/nallahs, road crossing using mechanised/ manual trenching/ HDD/ boring, other protection works ,back filling the excavated trenches and restoring the surface to original,release of empty OFC drums etc. This includes supply of all protection material not specifically asked for in the schedule.	Mtr	20520	70.7	1450764.00
1a	Laying of PLB HDPE duct by HDD method at a depth of 1.65 m or more (for single PLB pipe)	Mtr	3067	220.62	676641.54
1b	Construction & installation of route/joint indicators as per specification and the construction practices as specified in the tender.	No.	382	371.37	141863.34
2a	Chase cutting/jack hammering etc. upto a depth of 0.6m in rocky area ,laying of DWC pipe in trenches, protection works and back filling the excavation along with supply of the protection materials as per technical specification.	Mtr	33059	531.41	17567883.19
2b	Laying of DWC pipe in trenches already made in specified areas(dry culverts/bridges/nallah/lesser depth & congested areas etc.) in item 1	Mtr	2464	6.55	16139.20

SN	Description	Unit	Total Qty	Rate(Rs)	Amount (Rs)
				In figures	In figures
3a	Laying and Fixing of GI pipe with clamping/concreting for protection on culverts/bridges, along the hard rock (where surface cutting is not possible) and required work & fixing as per technical specification.	Mtr	4025	52.38	210829.50
3b	(i) Laying of GI pipe in trenches already made in specified areas(Road crossing etc.) in item 1	Mtr	284	10.92	3101.28
	(ii) Rail Crossing through Horizontal Boring method(HDD) and inserting 50mm dia GI pipes and pushing HDPE pipes/Coils inside.	Mtr	0	424.8	0.00
4	Laying of Flexible conduit pipe in corridor/risers/exchange premises and laying OF cable through it(leading in work)	Mtr	0	10.62	0.00
5	Laying of HDPE pipe in the trenches & protection works done as specified above	Mtr	58458	4.19	244939.02
6	Blowing/pulling of 24 F OFC as per technical specification.	Mtr	63651	7.15	455104.65
7	Splicing of Optical fiber cables in existing/new joint chambers for making straight/branch joints on new routes or at FPOI(fiber point of interconnect) and end to end testing of all fibers after splicing. The rates specified are inclusive of installation and splicing of splitters also wherever applicable, as per technical specification.	No.	69	6635.13	457823.97
8	Splicing of all the fibers of OFC in the Fibre Termination Box at the POP and testing all the fibers for continuity. This will also include installation/mounting of the FTB as specified and other work to meet end objective.	No.	0	6900.63	0.00
9	Construction & installation of pre fabricated RCC joints chambers/ brick chambers as per technical specification	No.	74	2336.4	172893.60

SN	Description	Unit	Total Qty	Rate(Rs)	Amount (Rs)
				In figures	In figures
10	Videography of the work/route	Mtr	60319	0.32	19302.08
11	Preparation of Route diagram and submission of hard as well as soft copy on CD/memory stick/HDD for complete blocks along with, test & measurements reports and all other documents, as per technical specification	Mtr	60319	0.11	6635.09
Total Cost of Schedule in Figure					25337840.00
Total Cost of Schedule in Words		Rupees Two Crore Fifty Three Lakh Thirty Seven Thousands Eight Hundred & Forty Only			

Note: The payment of supply items of GI/DWC/Flexible Conduit pipe etc. shall be done only for the quantities used in the project along with the laying. No positive variation in quantity of item No. 1 (a) of B, beyond the quantity specified in SOR, is allowed.



S NO	Schedule	Estimated Cost in Rs.
1	Schedule- (Porbandar)	2,53,37,840.00
	Total Cost of Tender in Figure (Rs.)	2,53,37,840.00
	Total Cost of Tender in Words	Rupees Two Crore Fifty Three Lakh Thirty Seven Thousands Eight Hundred & Forty Only

i.	I/we undertake to execute the work of schedule of work at -----% (in words-----percent), At Par/below/above of the RailTel's total estimated cost of schedule of work mentioned above.
ii.	It is certified that I/we have inspected the site of work and acquainted myself or ourselves with local conditions.
iii.	I/we have carefully gone through the specifications. Additional special conditions etc attached with the tender document.
iv.	I/we undertake to keep this offer valid for period indicated in Tender from the date of opening of Tender and further not to revoke the same before the expiry of such period.

Signature and Seal of the Tenderer

Note for Guidance	[i] Tenderer should quote his single percentage rate in row (i) above only, At par /above/below the RailTel's estimated cost of work.
	[ii] The single percentage rate to be quoted both in figures and words.
	[iii] Tenderer shall quote all inclusive rates, but there shall be break up of basic price and all type of applicable taxes such as CGST/IGST/UTGST/SGST etc. (including tax under reverse charges payable by the recipient under GST Act).
	[iv] If none of the above/below/at par is ticked by the tenderer, the quoted single percent will be treated below the RailTel's estimated rate.

RAILTEL
 A Government of India
 Undertaking

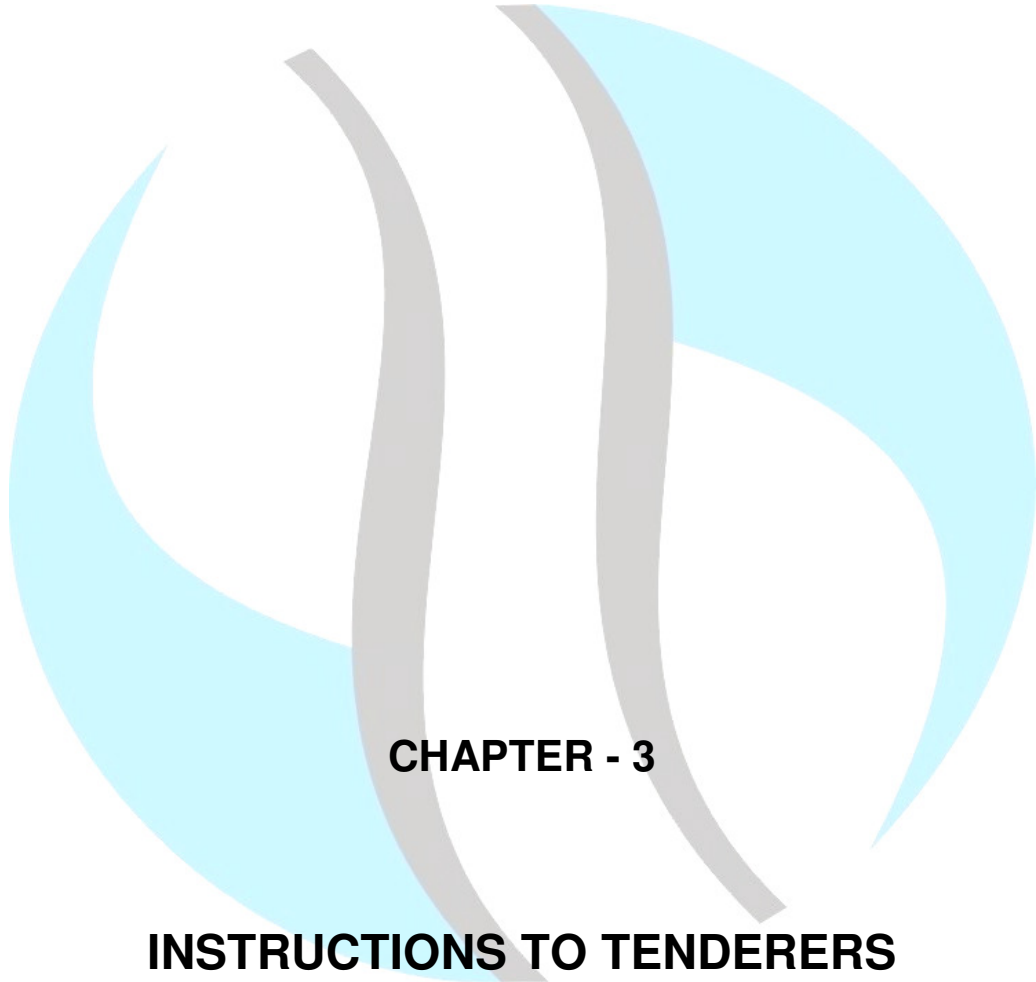

CHAPTER - 3

INSTRUCTIONS TO TENDERERS

AND

CONDITIONS OF TENDERING

रेलटेल
RAILTEL

**A Government of India
Undertaking**

INDEX

3. 1. General Instructions
3. 2. Interpretations
3. 3. Local Conditions
3. 4. Compliance to Tender Conditions, Specifications and Drawings
- 3.5. Earnest Money
- 3.6 Submission of Offers
3. 7 Constitution of Firm and Power of Attorney
- 3.8 Validity of Offer
- 3.9. Rates during Negotiations
- 3.10. Period of Completion and Time Progress Graph
- 3.11. Opening of Tender
- 3.12. Non-transferability and Non-refundability
- 3.13. Errors, Omissions and Discrepancies
- 3.14. Wrong Information by Tenderers
- 3.15 Amendment Of Bid Documents
- 3.16. Qualifying Criteria
- 3.17. Performance Bank Guarantee
- 3.18. Evaluation of offer
- 3.19 Agreement
- 3.20 Tenderer's Address

रेलटेल
RAILTEL
A Government of India
Undertaking

CHAPTER-3

INSTRUCTIONS TO TENDERERS AND CONDITIONS OF TENDERING

3.1 GENERAL INSTRUCTIONS

- 3.1.1 Tender is invited by RailTel , Western Region Mumbai, on the behalf of BBNL from established and reliable contractors for the work detailed in chapter 1 .
- 3.1.2 The Special Conditions of Contract, Instructions to Tenderers and Conditions of Tendering, Technical Specifications & Supplement, Preamble including Schedule of Requirements and all Annexure & Forms etc. shall, hereafter, be collectively referred to as the "**Tender documents** ". These regulations for Tender and Contracts shall be read in conjunction with the General Conditions of contract and shall be subject to modifications, additions or suppression, overwrite by Special conditions of contract and/or special specifications, if any , annexed to the tender document .

3.2 INTERPRETATIONS

The following terms wherever occurring in the tender document and wherever used throughout the execution of the work, shall, unless excluded by or repugnant to the context, have the meaning attributed thereto as follows:

- a) "**CONTRACT**" Means the Contract resulting from the acceptance by the Purchaser of this Tender whether in whole or in part.
- b) "**CONTRACTOR**" Means the successful Tenderer, i.e., the Tenderer whose Tender has been accepted either in whole or in part.
- c) "**CONTRACTOR's REPRESENTATIVE**" Shall mean a person in supervisory capacity who shall be so declared by the Contractor and who shall be authorized under a duly executed power of attorney to receive materials issued by the Purchaser to the Contractor for the works. He shall be responsible for proper execution of works at each or all places and shall take orders from Purchaser's Engineers and carry out the same.
- d) "**ENGINEER-IN-CHARGE**" Shall mean an executive of RailTel in charge of works and shall include the superior executives of RailTel. He is responsible for ensuring that all field works covered by the contract are carried out in accordance with approved designs, drawings & specifications and conditions of contract as agreed to.
- e) "**ENGINEER**" Shall mean the supervisor of RailTel in direct charge of the works.

A Government of India
Undertaking

- f) **"EQUIPMENT"** Means all or any equipment considered necessary by the Purchaser's Engineers for satisfactory operation, as a whole, of the installations.
- g) **"MONTH"** Means any consecutive period of thirty days.
- h) **"MATERIALS"** Means all equipments, components, fittings and other materials including raw materials required to complete the work..
- i) **"PURCHASER"** Means RailTel Corporation of India Limited, Western Railway Microwave Compound, Senapati Bapat Marg, Mahalaxmi-Mumbai- 400 013
- j) **"PURCHASER'S ENGINEER"** Means the Executive Director of RailTel or successor who will decide all matters relating to design, manufacture, and installation and commissioning of the plant and equipment at site.
- k) **"SUB-CONTRACTOR"** Means an individual or a firm of Contractor or a Company registered under Indian Company Act or an approved supplier of materials to whom the Contractor sublets portions of the contract.
- l) **"CONSIGNEE"** Means the person specified in the Acceptance of Tender to whom Stores are to be delivered at the destination.
- m) **"INSPECTING OFFICER"** Means the person, or organization specified in the contract for the purpose of inspection of stores of work under the contract and includes his/their authorized representative.
- n) **"RailTel"** Means RailTel Corporation of India Limited, Western Region, Western Railway Microwave Complex, Senapati Bapat Marg, Mahalaxmi-Mumbai- 400 013.
- o) **"SITE"** Means the areas to be taken up by the permanent works, together with any other area or areas as shall be determined by the Purchaser's Engineer, which may be placed at the disposal of the Contractor for the purpose of the contract and also such area or areas used for store yards, works yards or workshop in proximity of the works as the Purchaser's Engineer may have authorized as an extension of the site, irrespective of the terms and conditions under which they are occupied by the Contractor.
- p) **"TENDERER"** Means and includes any firm of engineers or Contractors or any company or body, corporate or otherwise, who submit the Tender which has been invited.
- q) **"WORK OR WORKS"** Means all or any of the items of the work for which the Tenderer /Contractor has Tendered/contracted according to the specifications, drawings and Annexure hereto annexed or to be implied there from, or incidental thereto or to be hereafter specified or

required in such explanatory instructions and drawings, being in conformity with the original specifications, drawings, Annexure and schedules and also such instructions and drawings additional to the aforementioned as may from time to time be issued by the Purchaser's Engineer during the progress of the contracted work.

- r) **“BBNL”**- Bharat broadband Network Limited
- s) **“Expected risk”**: DELETED.
- t). **“Near Relative”**: -
 The near relatives of all RailTel Employees either directly recruited or on deputation are prohibited from participation in tenders and execution of works in the different units of RailTel. The detailed guidelines in this regard are given in the following paragraphs: -
 - i) The near relatives for this purpose are defined as:
 - * Members of a Hindu Undivided family,
 - * They are husband and wife,
 - * The one is related to the other in the manner as father, mother, son (s) & son's wife (daughter-in-law), daughter(s), & daughter's husband (son-in-law), brother(s) & brother's wife, sister(s) & sister'(s) husband (brother-in-law).
 - ii) As per Government of India's CCS Conduct rule 4, no Government servant shall in the discharge of his official duties deal with any matter or sanction any contract to any company or for any other person if any member of his family is employed in that company or firm or under that person or if he or any member of his family is interested in such matter or contract in any other manner and the Govt. Servant shall refer every such matter or contract to his official superior. This clause is applicable to all RailTel employees in view of this as soon as any RailTel employee becomes aware of the above aspect, he must intimate this to the prescribed authority.
 - iii) The Company or firm or any other person is not permitted to tender for works in RailTel Unit in which his near relative(s) is (are) posted. the tender/work will be cancelled and earnest money/security deposit will be forfeited at any stage whenever it is so noticed. The department will not pay any damages to the company or firm or the concerned person. The company or firm or the person will also be debarred for further participation in the concerned unit.
 - * The format of the certificate to be given is
 "I S/o.....
r/o hereby certify that none of my relative(s) as defined in the tender document is/ are employed in RailTel unit . In case at any stage, it is found that the information given by me is false/ incorrect, RailTel shall have the absolute right to take any action as deemed fit/without any prior intimation to me".

- u) **"WRITING"** Includes all matters written, typewritten or printed either in whole or in part.
- v) **"Constructional Plant"** shall mean all appliances or things of whatsoever nature required for the execution, completion or maintenance of the works or the temporary works (as hereinafter defined) but do not include materials or other things intended to form or forming part of the permanent work. (i) "Temporary Works" shall mean all temporary works of every kind required for the execution, completion and/or maintenance of the works. (ii) "Period of maintenance" shall mean the specified period of the maintenance from the date of completion of the work as certified by the Engineer.
- w) Singular and Plural: Works importing the singular number shall also include the plural and vice versa where the context requires.
- x) Headings & marginal headings: The headings and marginal headings in these general conditions are solely for the purpose of facilitating reference and shall not be deemed to be part thereof or be taken into consideration in the interpretation or construction thereof or the contract.
- y) "Route" Means the continuous section of IL between two end points which may be existing FPOI/POP of BBNL or BSNL which will be decided by Engineer-In-Charge.

3.3 LOCAL CONDITIONS

- 3.3.1 It will be imperative on each tenderer to fully acquaint him with all the local conditions and factors which would have any effect on the performance of the contract and cost of the stores. The purchaser shall not entertain any request for clarifications from the tenderer regarding such local conditions. No request for the change of price or time schedule of delivery of works/stores shall be entertained after the offer is accepted on account of any local condition or factor.
- 3.3.2 The intending tenderer is advised to study the tender document carefully. Any submission of a quotation by the tenderer shall be deemed to have been done after a careful study and examination of these documents with full understanding of the implication thereof. These conditions and specifications shall be deemed to have been accepted unless otherwise, specifically commented upon by the Tenderer in his quotation. Failure to adhere to anyone or all these instructions may render his offer liable to be ignored without any reference.
- 3.3.3 Should a tenderer find discrepancies in, or omission from, the drawings or any of the Tender documents or he has any doubt to their meaning, he should at once notify the RailTel who may send a written clarification to all Tenderers.

3.4 COMPLIANCE TO TENDER CONDITIONS, SPECIFICATIONS & DRAWINGS

- 3.4.1 The tenderer shall indicate Paragraph by Paragraph for each section of the tender document that either his tender complies in every respect with the requirements of each clause and sub clause or if not, precisely how they differ from the requirements of the tender. In later case, the tenderer shall enclose a separate statement as per proforma given, indicating only the deviations for any clause or sub clause of Special Conditions of Contract, Instructions to Tenderers and Conditions of Tendering, Technical Specifications, Preamble etc. which he proposes with justifications for deviations proposed. The purchaser reserves the right to accept or reject these deviations and his decision thereon shall be final (see Form 5).
- 3.4.2 The material offered and execution of work shall be in accordance with the drawings and specifications. Details of variation from the drawings and specifications, if any, should be clearly indicated separately for each annexure with justification for deviations proposed. The Purchaser reserves the right to accept or reject these deviations and his decision thereon shall be final.
- 3.4.3 Firms should give details of similar works carried out giving details of the name of the project, date of award, length of the section, value of the contract, the original execution period and the actual execution time taken.
- 3.4.4 The tenderer should serially number all the pages of the bid

3.5 EARNEST MONEY

- 3.5.1 The tenderer shall furnish an amount given in "Para-1.11 of tender document" as earnest money in favour of **NOFN EXPENDITURE CURRENT ACCOUNT WR** payable at Mumbai
- 3.5.2 **The Earnest Money should be in any of the following forms:-**
Pay orders, demand drafts, bankers cheque. These forms of earnest money should be issued from any of the nationalized banks/ Schedule banks.
- 3.5.3 The tenderers shall hold the offer open till such date as specified in Para 1.8 of the tender document. It being understood that the tender documents have been sold/issued to the tenderer and the tenderer has been permitted to tender in consideration of the stipulation on his part that after submitting his tender he will not resile from his offer or modify the terms and conditions thereof in a manner not acceptable to RailTel. If the tenderer fails to observe or comply with the foregoing stipulation, the aforesaid amount deposited as Earnest Money shall be liable to be forfeited by RailTel.
- 3.5.4 **The earnest money may be forfeited.**
a) If tenderer withdraws its tender during the period of tender validity specified in Para 1.8 of tender document.

b) In the case of successful tenderer, If the tenderer fails to sign the contract in accordance with Para 5.2 of Special Conditions of Contract and to furnish Performance Bank Guarantee in accordance with Para 1.13 of tender document.

3.5.5 The Earnest money of unsuccessful tenderer will save as herein before provided, be returned within reasonable time to the unsuccessful tenderer but RailTel shall not be responsible for any loss or depreciation that may happen to the security for the due performance of the above stipulation to keep offer open for the period specified in the tender documents or to the Earnest Money while in their possession nor be liable to pay interest thereon.

3.5.6 If the tender is accepted, the amount of Earnest Money will be held as security deposit for due and faithful fulfillment of contract.

3.5.7 The tender not accompanied by Earnest Money as mentioned in Para 3.5.1 of the tender document will be **summarily rejected**.

3.5.8 i. The MSE/NSIC units shall be exempted up to the extent of their monetary limit from submission of EMD deposit on production of requisite proof in respect of valid certification from MSME/NSIC for the tendered items.

ii. The MSE/NSIC units shall be exempted from submission of cost of tender document on production of requisite proof in respect of valid certification from MSME/NSIC for the tendered items.

iii. Other benefits applicable to this tender shall be extended as per guidelines issued in latest notifications of Ministry of MSME/Government of India.

3.6 **SUBMISSION OF OFFERS**

3.6.1 All offers in the prescribed forms should be submitted before the time and date fixed for the receipt of the offers. Offers received after the stipulated time and date will be summarily rejected.

3.6.2 In case the date of opening happens to be a holiday, the tender will be received and opened at the same time on the next working day.

3.6.3 All offers shall be either type written or written neatly in indelible ink in English. Each page of the offer must be numbered consecutively. A reference to total number of pages comprising the offer must be made at the top right hand corner of the top page. The supporting documents should be submitted either in original or duly signed by the authorized signatory of the tenderer. The original documents shall be produced for verification when called for.

3.6.4 **Quote in Figures and Words**

All information like discounts etc. having a bearing on the price shall be written both in figures and in words in the prescribed offer form. The tenderer is advised to quote single percentage rate At Par/below/above of the RailTel's total estimated cost for schedule of work. In case of difference in words and figures the amount written in words shall be taken into consideration. In the event of any discrepancy between percentage rate and total cost, the value shown in percentage rate will be taken for evaluation purpose. In case the schedule of work quoted by tenderer is incomplete with reference to tender document, the offer is liable to be rejected

Tenderer shall quote all inclusive rates, but there shall be break up of basic price and all type of applicable taxes such as CGST/IGST/UTGST/SGST etc.

(including tax under reverse charges payable by the recipient under GST Act).

3.6.5 **Attestation of alterations**

No scribbling is permissible in the tender documents. Tender containing erasures and alterations in the tender documents are liable to be rejected. Any correction made by the tenderer/ tenderers in his/their entries must be signed (not initialed) by him/them.

3.6.6 **Tender bid**

The tender bid should be submitted in single cover. **The envelop should bear the tender no., its description & date of closing.**

The original tender documents purchased from this office/ down loaded from web site shall be submitted with each page duly signed and stamped along with the original offer

Tender Bid :The tender bid shall consists of the following:-

- i) Offer letter complete. (Form No.1)
- ii) Schedule of Requirements
- iii) Earnest Money in prescribed form. (Para 3.5 of tender document)
- iv) Audited balance sheet for last three financial years
- v) Constitution of Firm and Power of Attorney (in case of partnership firm).
- vi) Clause wise compliance to tender conditions by signing of each page of tender document & statement of deviations .(Form No.5)
- vii) Similar works executed . Form No. 13 (Para 3.16.2 of tender document)
- viii) User's Certificate Form No. 2 (Para 3.16.1.2 of tender document)
- ix) Any other information desired to be submitted by the tenderer.
- x) Copy of registration/exemption certificate for EPF.
- xi) Registration with labour commissioner
- xii) GST registration
- xiii) The present work load of the telecom contracts in hand as per the Format (Form 9) (Para 1.7 of tender document) .
- xiv) MSE/NSIC registration certificate if the bidder is claiming concession for EMD & Cost of tender document.
- xv) Relevant documents for JV Firms as per clause 3.7.6.

3.7 CONSTITUTION OF FIRM AND POWER OF ATTORNEY

- 3.7.1 Any individual(s) signing the tender or other documents connected therewith should specify whether he is signing:-
- (a) As sole proprietor of the concern or as attorney of the sole proprietor;
 - (b) As a partner or partners of the firm;
 - (c) As a Director, Manager or Secretary in the case of Limited Company duly authorized by a resolution passed by the Board of Directors or in pursuance of the authority conferred by Memorandum of Association.
- 3.7.2 In the case of a firm not registered under the Indian Partnership Act, all the partners or the attorney duly authorized by all of them should sign the tender and all other connected documents. The original Power of Attorney or other documents empowering the individual or individuals to sign should be furnished to the Purchaser for verification, if required.
- 3.7.3 The RailTel will not be bound by Power of Attorney granted by the tenderer or by the changes in the composition of the firm made subsequent to the execution of the contract agreement.
- 3.7.4 In case where the Power of Attorney partnership deed has not been executed in English, the true and authenticated copies of the translation of the same by Advocate, authorized translators of Courts and Licensed Petition Writers should be supplied by the Contractor(s) while tendering for the work.
- 3.7.5 The duly notarized Power of Attorney, Partnership Deed, Memorandum of Joint Venture as the case may be in original or duly signed.

3.7.6 Participation Of Joint Venture (JV) Firms In Works Tender :

1. Separate identity/name shall be given to the Joint Venture Firm.
2. Number of members in a JV Firm shall not be more than three.
3. A member of JV Firm shall not be permitted to participate either in individual capacity or as a member of another JV Firm in the same tender.
4. The tender form shall be purchased and submitted only in the name of the JV Firm and not in the name of any constituent member.
5. Normally Earnest Money Deposit (EMD) shall be submitted only in the name of the JV Firm and not in the name of constituent member. However, in exceptional cases, EMD in the name of Lead Member can be accepted subject to submission of specific request letter from Lead Member stating the reasons

for not submitting EMD in the name of JV Firm and giving written confirmation from JV members to the effect that EMD submitted by the Lead Member may be deemed as EMD submitted by JV Firm.

6. One of the members of the JV Firm shall be its Lead Member who shall have a majority (at least 51%) share of interest in the JV Firm and also, must have satisfactorily completed the work in accordance with the clause 3.16.2.1 (chapter 3) of the tender. The other members shall have a share of not less than 20% each. In case of JV Firm with foreign member(s), the Lead Member has to be an Indian Firm with a minimum share of 51%.
7. A copy of Memorandum of Understanding (MoU) executed by the JV members shall be submitted by the JV Firm alongwith the tender. The complete details of the members of the JV Firm, their share and responsibility in the JV Firm etc. particularly with reference to financial, technical and other obligations shall be furnished in the MoU. (MOU format at Appendix-I).
8. Once the tender is submitted, the MoU shall not be modified / altered / terminated during the validity of the tender. In case the tenderer fails to observe/comply with this stipulation, the full Earnest Money Deposit (EMD) shall be liable to be forfeited.
9. Approval for change of constitution of JV Firm shall be at the sole discretion of the RailTel. The constitution of the JV Firm shall not be allowed to be modified after submission of the tender bid by the JV Firm, except when modification becomes inevitable due to succession laws etc. and in any case the minimum eligibility criteria should not get vitiated. However, the Lead Member shall continue to be the Lead Member of the JV Firm. Failure to observe this requirement would render the offer invalid.
10. Similarly, after the contract is awarded, the constitution of JV Firm shall not be allowed to be altered during the currency of contract except when modification become inevitable due to succession laws etc. and in any case the minimum eligibility criteria should not get vitiated. Failure to observe this stipulation shall be deemed to be breach of contract with all consequential penal action as per contract conditions.
11. On award of contract to a JV Firm, a single Performance Guarantee shall be submitted by the JV Firm as per tender conditions. All the Guarantees like Performance Guarantee, Bank Guarantee for Mobilization Advance, Machinery Advance etc. shall be accepted only in the name of the JV Firm and no splitting of guarantees amongst the members of the JV Firm shall be permitted.
12. On issue of LOA (Letter Of Acceptance), an agreement among the members of the JV Firm (to whom the work has been awarded) shall be executed and got registered before the Registrar of the Companies under Companies Act or before the Registrar/Sub-Registrar under the Registration Act, 1908. This JV Agreement shall be submitted by the JV Firm to the RailTel before signing the contract agreement for the work. In case the tenderer fails to observe/comply with this stipulation, the full Earnest Money Deposit (EMD) shall be forfeited and

other penal actions due shall be taken against partners of the JV and the JV. This Joint Venture Agreement shall have, inter-alia, following Clauses :

- 12.1. Joint And Several Liability - Members of the JV Firm to which the contract is awarded, shall be jointly and severally liable to the (RailTel) for execution of the project in accordance with General and Special Conditions of Contract. The JV members shall also be liable jointly and severally for the loss, damages caused to the RailTel during the course of execution of the contract or due to non-execution of the contract or part thereof.
- 12.2. Duration of the Joint Venture Agreement - It shall be valid during the entire currency of the contract including the period of extension, if any and the maintenance period after the work is completed.
- 12.3. Governing Laws - The Joint Venture Agreement shall in all respect be governed by and interpreted in accordance with Indian Laws.
13. Authorized Member - Joint Venture members shall authorize one of the members on behalf of the Joint Venture Firm to deal with the tender, sign the agreement or enter into contract in respect of the said tender, to witness joint measurement of work done, to sign measurement books and similar such action in respect of the said tender/contract. All notices/correspondences with respect to the contract would be sent only to this authorized member of the JV Firm.
 - 13.1 Any Payment shall be released to the Joint Venture and not to the one member and accordingly Joint Venture shall have PAN of the Joint Venture firm.
14. No member of the Joint Venture Firm shall have the right to assign or transfer the interest right or liability in the contract without the written consent of the other members and that of the RailTel in respect of the said tender/contract.
15. Documents to be enclosed by the JV Firm alongwith the tender :
 - 15.1. In case one or more of the members of the JV Firm is/are partnership firm(s), following documents shall be submitted :
 - (a) Notary certified copy of the Partnership Deed,
 - (b) Consent of all the partners to enter into the Joint Venture Agreement on a stamp paper of appropriate value (in original).
 - (c) Power of Attorney (duly registered as per prevailing law) in favour of one of the partners of the partnership firm to sign the JV Agreement on behalf of the partnership firm and create liability against the firm.
 - 15.2. In case one or more members is/are Proprietary Firm or HUF, the following documents shall be enclosed :

Affidavit on Stamp Paper of appropriate value declaring that his/her Concern is a Proprietary Concern and he/she is sole proprietor of the Concern OR he/she is in position of "KARTA" of Hindu Undivided Family (HUF) and he/she has the authority, power and consent given by other partners to act on behalf of HUF.

15.3. In case one or more members is/are limited companies, the following documents shall be submitted :

- (a) Notary certified copy of resolutions of the Directors of the Company, permitting the company to enter into a JV agreement, authorizing MD or one of the Directors or Managers of the Company to sign JV Agreement, such other documents required to be signed on behalf of the Company and enter into liability against the company and/or do any other act on behalf of the company.
- (b) Copy of Memorandum and Articles of Association of the Company.
- (c) Power of Attorney (duly registered as per prevailing law) by the Company authorizing the person to do/act mentioned in the para (a) above.

15.4. All the Members of JV shall certify that they are not black listed or debarred by RailTel, Railways or any other Ministry / Department / PSU (Public Sector Undertaking) of the Govt. of India/State Govt. from participation in tenders/contract on the date of opening of bids either in their individual capacity or as a member of the JV Firm in which they were/are members.

16. Credentials & Qualifying Criteria : Technical and financial eligibility of the JV Firm shall be adjudged based on satisfactory fulfillment of the following criteria :

16.1. Technical Eligibility Criteria :

Either the JV Firm or Lead Member of the JV Firm must comply clause 3.16.2.1 of Chapter-3.

Note : Value of a completed work done by a Member in an earlier JV Firm shall be reckoned only to the extent of the concerned member's share in that JV Firm for the purpose of satisfying his/her compliance to the above mentioned technical eligibility criteria in the tender under consideration.

16.2. Financial Eligibility Criteria : The contractual payments received by the JV Firm or the arithmetic sum of contractual payments received by all the members of JV Firm in the previous three financial years and the current financial year upto the date of opening of tender shall be at least 150% of the estimated value of the work as mentioned in the tender.

Note : Contractual payment received by a Member in an earlier JV Firm shall be reckoned only to the extent of the concerned member's share in that JV Firm for the purpose of satisfying compliance of the above mentioned financial eligibility criteria in tender under consideration.

Appendix-1

Memorandum of Understanding (MOU) for Joint Venture Participation

(To be executed on non-judicial stamp paper of appropriate value in accordance with relevant stamp Act. The stamp paper to be in the name of the company who is issuing the Power of Attorney).

**JOINT VENTURE PARTICIPATION
BETWEEN**

M/s.....having its registered office at (hereafter referred to as.....) acting as the Lead Partner of the first part and

M/s.....having its registered office at(hereafter referred to as ‘.....’) in the capacity of a Joint Partner of the other part. (If more than two partners include the details accordingly).

Now all the parties i.e. _____ and _____ will be known as M/s _____ (JV).

The expressions ofandshall whatever the context admits, mean and include their respective legal representatives, successors-in-interest and assigns and shall collectively be referred to as “the Parties” and individually as “the Party”

WHEREAS; **RailTel Corporation Of India Ltd.** (hereinafter referred to as “RailTel”) has invited bids for(insert name of work)
.....

NOW, THEREFORE, THE PARTIES AGREE AS FOLLOWS:

1. The ‘Parties’ have studied the documents and have agreed to submit their bid as Joint Venture (JV).
2. M/s.....shall be the lead member of the JV for all intents and purpose and shall represent the Joint Venture in its dealing with the RailTel. For the purpose of submission of Tender proposals, the parties agree to nominate M/sas the leader duly authorized to sign and submit all documents and subsequent clarifications, if any, to the RailTel.
3. The ‘Parties’ have resolved that the distribution of share and responsibilities is as under:
 - a) Lead Partner share%;
Responsibilities. i)

- ii)
 - iii)

(Technical, Financial & other obligations)
- b) Other Joint Venture Partner's share -----%

Name

Responsibilities.

(Technical, Financial & other obligations)

 - i)
 - ii)
 - iii)
- c) Other Joint Venture Partner's share -----%

Name

Responsibilities.

(Technical, Financial & other obligations)

 - i)
 - ii)
 - iii)

4. JOINT AND SEVERAL RESPONSIBILITY

The Parties undertake that they shall be jointly and severally liable to the RailTel for execution of the Project in accordance with General and Special Conditions of Contract. The JV members shall also be liable jointly and severally for the loss, damages caused to the RailTel during the course of execution of the contract or due to non-execution of the contract or part thereof.

5 ASSIGNMENT AND THIRD PARTIES

No member of the Joint Venture firm shall have the right to assign or transfer the interest, right or liability in the contract without the written consent of the other members and that of the RailTel in respect of the said tender/contract.

6 EXECUTIVE AUTHORITY

Joint Venture members shall authorize one of the members on behalf of the Joint Venture Firm to deal with the tender, sign the agreement or enter into contract in respect of the said tender, to witness joint measurement of work done, to sign measurement books and similar such action in respect of the said tender/contract. All notices/correspondences with respect to the contract would be sent only to this authorized member of the JV firm.

Any Payment shall be released to the Joint Venture and not to the one member and accordingly Joint Venture shall have PAN of the Joint Venture firm.

7. VALIDITY

This MOU shall remain in force till the occurrence of the earliest of the following, unless by mutual consent, the parties agree in writing to extend the validity for a further period.

- a. Tender submitted by the joint venture is declared unsuccessful, or
- b. Cancellation/shelving of the project by the RailTel for any reasons prior to award of work.

In case, the Tender submitted by the joint venture is declared successful; the validity of this MOU shall be extended till the JV agreement is signed and got ratified.

8. This MOU is drawn innumber of copies with equal legal strength and status. One copy is held by M/s..... and the other by M/s. &M/s..... and a copy submitted with the proposal.

9. This MOU shall in all respects be governed by and interpreted in accordance with Indian Laws.

10. NOTICES

Notices shall be given in writing by Fax confirmed by registered mail or commercial courier to the following Fax numbers and addresses.

.....
.....
.....

11. JV Agreement.

We are aware, that after issue of LOA by RailTel, an agreement among the members of the JV firm has to be executed and got registered before the Registrar of Companies under the Companies Act or with the Registrar/Sub-Registrar under the Registration Act. This agreement shall be submitted by the JV firm to RailTel before signing the contract agreement for the work. In case the JV partners fail to observe/comply with stipulations, the Earnest Money Deposit, deposited with the RailTel shall be forfeited and other penal actions due shall be taken against partners of the JV and the JV by the RailTel.

12. We shall furnish along with the tender requisite documents as mentioned under para 15.1, 15.2, 15.3 (as the case may be) of the guidelines of RailTel for participation of J.V. firms in works tender.

Declaration

It is to certify that we have not been black listed or debarred by the RailTel, Railways or any other ministry/departments of the Govt. of India/State Govt. from participation intenders/contract in the past either in our individual capacity or the J.V. firm or partnership firm in which we were members/partners.

Lead Partner

(Name and Address)

Other Partner(s).

(Name and Address)

Name and Address of the J.V. firm

IN WITNESS WHEREOF THE PARTIES, have executed this MOU the day, month and year

first
before written.
M/s.....

M/s.....
.....
(Seal)

(Seal)

Witness:

1. (Name & Address)

2. (Name & Address)

3.8 VALIDITY OF OFFER

The tenderer should keep the offers valid for the period as mentioned in Para 1.8 of tender document.

3.9 RATES DURING NEGOTIATION

The tenderer/s shall not increase his/their quoted rates in case the RailTel Administration negotiates for reduction of rates. Such negotiations shall not amount to cancellation or withdrawal of the original offer and the rates originally quoted will be binding on the tenderer/s.

3.10 PERIOD OF COMPLETION AND TIME PROGRESS GRAPH

The works/work are/is to be completed within a period as mentioned in Para 1.9 of the tender document from the date of issue of Letter of Acceptance of the tender.

3.11 OPENING OF TENDER:

Tender shall be opened at the time & date of the tender given in the Para 1.5, in the presence of such Tenderers/Authorized representatives who choose to be present.

3.12 NON-TRANSFERABILITY AND NON-REFUNDABILITY

The tender documents are not transferable. The cost of tender documents is not refundable.

3.13 ERRORS, OMISSIONS & DISCREPANCIES

The Contractor(s) shall not take any advantage of any mis-interpretation of the conditions due to typing or any other error and if in doubt, shall bring it to the notice of the Engineer without delay. In case of any contradiction only the printed rules, and books should be followed and no claim for the miss-interpretation shall be entertained.

3.14 WRONG INFORMATION BY TENDERER

If the tenderer/s deliberately gives/give wrong information in his/their tender which creates/create circumstances for the acceptance of his/their tender the RailTel reserves the right to reject such tender at any stage.

3.15 AMENDMENT OF BID DOCUMENTS:

- 3.15.1** At any time, prior to the date for submission of bids, the RAILTEL may, for any reason whether suo motto or in response to clarification requested by a prospective Bidder, modify the bid documents by amendments.
- 3.15.2** The amendments shall be posted on website of RailTel and all bidders should download from website. These amendments will be binding on all bidders. RailTel shall make efforts to inform in writing or Fax to all prospective bidders on the address intimated at the time of purchase of bid documents from the RailTel. Those who are downloading tender document from website should download the clarification also and submit with the tender document.
- 3.15.3** In order to afford prospective bidders reasonable time to take the amendments into account in preparing their bids, the RAILTEL may, at its discretion, extend the deadline for the submission/opening of bids suitably.

3.16 QUALIFYING CRITERIA

3.16.1 General

- 3.16.1.1** The tenderer should submit the details of experience of similar works or services in the projects executed / under execution which should clearly bring out expertise in the work as per Form no. 13.
- 3.16.1.2** The tenderer/s must submit along with his/their tender, certificates from the original user for whom the project was undertaken certifying the date of award of contract, date of completion, date of commissioning and the present working state of the system so established. The tenderer shall submit these certificates for all the projects that he has executed which only satisfy the minimum requirements in each case. The certificates are to be submitted in original or their true copies duly signed by the tenderer, preferably as per Form no. 2.

3.16.2 Technical Capability and meaning of similar single work:

- 3.16.2.1** Tenderer should have completed at the time of tender opening during the last three financial years i.e. current year & three previous financial years
- a) At least one similar work for a minimum value of 35% of the advertised Tender Value.
- OR**
- b) Two similar works for a minimum value of 20% of the advertised Tender Value each.

OR

- c) Three similar works for a minimum value of 15% of the advertised Tender Value each

3.16.2.2 Definition of similar single work is as under-

Works similar to the scope of work as contained in this tender shall mean

- i) All type of Telecom equipment/OFC including telecom cable works, OFC maintenance works.

OR

- ii) Any type of Railway Signaling works etc.

OR

- iii. Any type of Electrical works/Transmission Line works etc.

OR

- iv) Civil engineering works like road construction, building construction works, pipe laying works(Gas, Sewer etc.) or similar civil works..

The work should have been executed for Govt. /PSUs / Telecom Service Providers/Infrastructure Providers.”

3.16.3 Financial:

- i. Total contract amount received during the last 3 financial years and in the current financial year should be a minimum of 150% of advertised tender value. The certified copy of three years Audited Balance Sheet and Income statement of just concluded year should be submitted as evidence .
- ii. In case of JV company/Firm, Financial eligibility criteria should be fulfilled as indicated in Clause 3.7.6 Para 16.2.

The tenderer should have Registration No./GST ID for WCT/GST in respective state where work is to be executed and any other statutory registration that will be introduced by Govt.of India/State Govt.of India during the currency of the contract or the tenderer shall give the undertaking to submit the same on acceptance of tender in respective state where work is to be executed.

Declaration under GST Act to be furnished as per form no .14 & 15

3.16.4 Engineering Organization

The tenderer shall depute required number of Engineers and experienced supervisors for planning, supervision and execution of the work. The qualification and experience of these proposed personnel should be enclosed along with the bid.

3.16.5 Construction and Maintenance Machinery

The tenderer should furnish the details of the machinery and plants to be deployed, in case the tenderer plans to use mechanized trenching.

3.17 Refer para 5.3 of chapter 5 (Special Conditions of contract) of tender document.

3.18 EVALUATION OF OFFER

3.18.1 The authority for the acceptance of the tender rests with the Purchaser. The tenders received will be evaluated by the Purchaser to ascertain the best acceptable tender in the interest of the Purchaser.

3.18.2 However, the purchaser shall not be bound to accept the lowest or any tender. The purchaser reserves the right to accept any tender in respect of the whole or any portion of the work specified in the tender paper or to sub-divide the work among different Tenderers or to reduce the work or to accept any tender for less than the tendered quantities.

3.19 AGREEMENT

The successful tenderer/s shall be required to execute an agreement with RailTel for carrying out the work as per the tender document.

In case of AMC, a separate agreement shall be executed for maintenance work .

3.20 TENDERER'S ADDRESS

Tenderer shall state in the tender his postal address fully and clearly. Any communication sent to the tenderers by post at his said address shall be deemed to have reached the tenderer duly & timely, notwithstanding the fact that the communication could not reach the tenderer at all or in time for whatever reason. Important documents shall be sent by Registered Post.



A Government of India
Undertaking

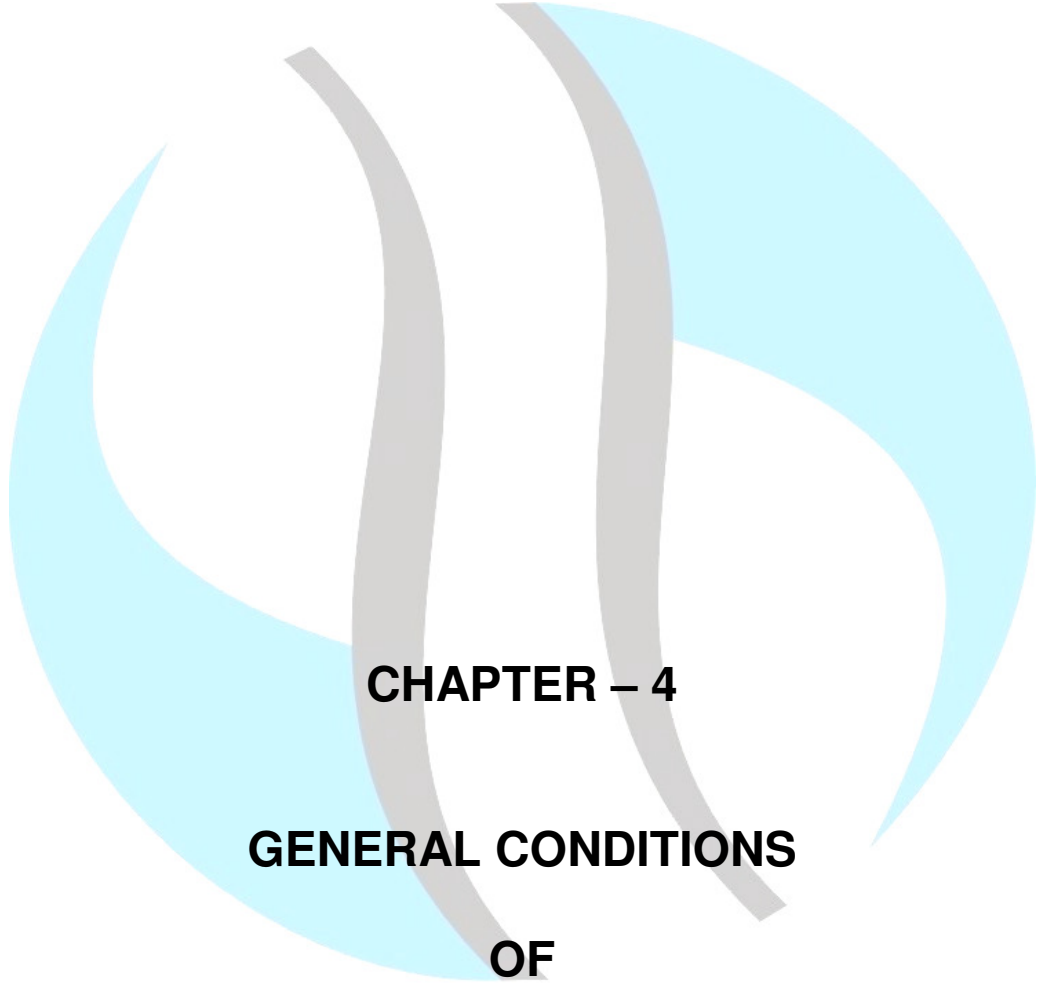

CHAPTER – 4

GENERAL CONDITIONS

OF

CONTRACT

रेलटेल
RAILTEL

**A Government of India
Undertaking**

CHAPTER - 4**GENERAL CONDITIONS OF CONTRACT****INDEX**

Para	Subject
4.1.	Definitions
4.2.	General Obligations
4.3.	Law governing the Contract
4.4.	Communications to be in writing
4.5.	Service of Notice on Contractors
4.6.	Occupation and use of land
4.7.	Assignment or subletting of contract
4.8.	Assistance by the RailTel for the stores to be obtained by the Contractor.
4.9.	Railway Passes
4.10.	Carriage of materials
4.11.	Force Majeure Clause
4.12.	Representation of works
4.13.	Relics and Treasures
4.14.	Excavated material
4.15.	indemnity by Contractors
4.16.	Security Deposit
4.17.	Completion Period
4.18.	Illegal Gratification
4.19.	Execution of Works
4.20.	Compliance to Engineer's Instructions
4.21.	Instructions of Engineer's Representative
4.22.	Adherence to specifications and drawings
4.23.	Working during night
4.24.	Damage to Railway/RailTel property or private life and property.
4.25.	Sheds, Store houses and Yards
4.26.	Provision of efficient and competent staff
4.27.	Workmanship and Testing
4.28.	Facilities for Inspection
4.29.	Examination of work before covering up
4.30.	Temporary Works
4.31.	Contractor to supply water for works

- 4.32. **Property in material and Plants**
- 4.33. **Tools, Plant and Materials supplied by RailTel**
- 4.34. **Precaution during progress of work**
- 4.35. **Use of Explosives**
- 4.36. **Suspension of Works**
- 4.37. **Rates for items of works**
- 4.38. **Demurrage and wharfage dues**
- 4.39. **Rates for extra items of works**
- 4.40. **Handing over of works**
- 4.41. **Variations in extent of contract**
- 4.42. **Powers of modification to contract**
- 4.43. **Claims**
- 4.44. **Measurements, certificates and payments**
- 4.45. **Measurement of Works**
- 4.46. **“On-Account” Payments**
- 4.47. **Maintenance of Works**
- 4.48. **Certificate of Completion of works**
- 4.49. **Approval only by Final Acceptance Certificate(FAC)**
- 4.50. **Final Acceptance Certificate**
- 4.51. **Final Payment**
- 4.52. **Withholding and lien in respect of sums claimed**
- 4.53. **Signature on receipts for amounts**
- 4.54. **Labour**
- 4.55. **Provisions of Payment of Wages Act**
- 4.56. **Reporting of Accidents to Labour**
- 4.57. **Provisions of Workmen’s Compensation Act**
- 4.58. **RailTel not to provide quarters for Contractor**
- 4.59. **Labour Camps**
- 4.60. **Non-employment of Labourers below the age of 15**
- 4.61. **Determination of Contract**
- 4.62. **Termination of Contract owing to default of Contractor**
- 4.63. **Matters finally determined by RailTel**
- 4.64. **Settlement of dispute and arbitration**

RAILTEL
A Government of India
Undertaking

Chapter - 4

GENERAL CONDITIONS OF CONTRACT

DEFINITIONS AND INTERPRETATION

4.1. Definitions:

4.1.1 The meaning of terms/interpretations shall be taken as defined in Chapter- 3

(INSTRUCTIONS TO TENDERERS AND CONDITIONS OF TENDERING).

4.2. GENERAL OBLIGATIONS

4.2.1 Execution Co-relation and intent of contract documents: The contract documents shall be signed in triplicate by the RailTel and the Contractor. The contract documents are complementary, and what is called for by any one shall be as binding as if called of try all; the intention of the documents is to include all labour and materials, equipments and transportation necessary for the proper execution of work. Materials or work not covered by or properly inferable from any heading or class of the specifications shall not be supplied by the RailTel to the contractors unless distinctly specified in the contract documents. Materials or works described in words, which so applied, have a well-known technical or trade meaning shall be held to refer to such recognized standards.

4.2.2 If a work is transferred from the jurisdiction of one region of RailTel to another region or to a Project authority or vice versa while the contract is in subsistence, the contract shall be binding on the Contractor and the other region in the same manner & take effect in all respects as if the Contractor and the other region were parties thereto from the inception and the corresponding officer or the competent authority in the other region will exercise the same powers and enjoy the same authority as conferred to the Predecessor RailTel/Project under the original contract/agreement entered into.

4.2.3 If for administrative or other reasons the contract is transferred to the other region of RailTel the contract shall notwithstanding anything contained herein contrary thereto, be binding on the Contractor and the other region in the same manner and take effect in all respects as if the contractor and the other region had been parties thereto from the date of this contract.

4.3. Law governing the contract

4.3.1 The Contract shall be governed by the law for the time being in force in the Republic of India.

4.3.2 Compliance to regulations and bye-laws – The Contractor shall conform to the provision of any statute relating to the works and regulations and bye-laws of any local authority and of any water and lighting companies or undertakings, with whose system the work is proposed to be connected and shall before

making any variation from the drawings or the specifications that may be necessitated by so confirming give to the Engineer notice specifying the variation proposed to be made and the reason for making the variation and shall not carry out such variation until he has received instructions from the Engineer in respect thereof. The Contractor shall be bound to give all notices required by statute, regulations or by laws as aforesaid and to pay all fees and taxes payable to any authority in respect thereof.

- 4.4. Communications to be in writing** – All notices, communications, references and complaints made by the RailTel or the Engineer or the Engineer's representative or the Contractor interest concerning the works shall be in writing and no notice, communication, references or complaint not in writing shall be recognized.
- 4.5. Service of Notices on Contractors** – The Contractor shall furnish to the Executive Director/RailTel the name, designation and address of his authorized agent and all complaints, notices, communications and references shall be deemed to have been duly given to the contract if delivered to the Contractor or his authorized agent or left at or posted to the address so given and shall be deemed to have been so given in the case of posting on day on which they would have reached such address in the ordinary course of post or on the day on which they were so delivered or left. In the case of contract by partners, any change in the constitution of the firm shall be forthwith notified by contractor to the Executive Director /RailTel.
- 4.6. Occupation and use of land** – No land belonging to or in the possession of the Railway/RailTel shall be occupied by the contractor without the permission of the RailTel. The Contractor shall not use, or allow to be used, the site for any purposes other than that of executing the works.
- 4.7. Assignment or subletting of contract:** - The Contractor shall not assign or sublet the contract or any part thereof or allow any person to become interested therein in any manner whatsoever without the special permission in writing of the RailTel. Any breach of this condition shall entitle the RailTel to rescind the contract under Para 4.62 of these conditions and also render the contractor liable for payment to the RailTel in respect of any loss or damage arising or ensuring from such cancellation. Provided always that execution of the details of the work by petty contractor under the direct and personal supervision of the contractor or his agent shall not be deemed to be sub-letting under this clause. The permitted subletting of work by the contractor shall not establish any contractual relationship between the sub-contractor and the RailTel and shall not relieve the Contractor of any responsibility under the Contract.
- 4.8. Assistance by the RailTel for the stores to be obtained by the Contractor:** Owing to difficulty in obtaining certain materials (including Tools & Plants) in the market, the RailTel may have agreed without any liability therefore, to endeavor to obtain or assist the Contractor in obtaining the required quantities of such materials as may be specified in the Tender. In the event of delay or failure in obtaining the required quantities of the aforesaid materials, the Contractor shall not be deemed absolved of his own responsibility and shall keep in touch with the day-to-day position regarding their availability and accordingly adjust

progress of works including employment of labour and the RailTel shall not in any way be liable for the supply of materials or for the non supply thereof for any reasons whatsoever not for any loss or damage arising in consequence of such delay or non supply.

- 4.9. Railway Passes** – No free Railway passes shall be issued by the RailTel to the Contractor or any of his employee/worker.
- 4.10. Carriage of materials** – No forwarding orders shall be issued by the RailTel for the conveyance of Contractor's materials, tools and plant by Rail which may be required for use in the works and the contractor shall pay full freight at public tariff rates therefore.
- 4.11. Force Majeure Clause** -If at any time, during the continuance of this Contract, the performance, in whole or part, by either party, of any obligation under this contract shall be prevented or delayed by reason of any war, hostility, act of the public enemy, Civil Commotion, Sabotage, Fires, Floods, Earth quakes, explosions, strikes, epidemics, quarantine restrictions, lockouts, any statute, statutory rules/ regulations, order of requisitions issued by any Government Department or Competent Authority of acts of God (here-in-after referred to as event) then provided notice of the happening of any such event is given by either party to the other within twenty one days from the date of occurrence thereof, neither party shall, by reason of such event, be entitled to terminate this Contract nor shall either party have any claim for damage against the other in respect of such non- performance or delay in performance, and the obligations under the Contract shall be resumed as soon as practicable after such event has come to an end or ceased to exist, provided further that if the performance in whole or part of any obligation under this Contract is prevented or delayed by reason of any such event beyond a period as mutually agreed to by the RailTel and the Contractor after any event or 60 days in the absence of such an agreement whichever is more, either party may at its option terminate the Contract provided also that if the contract is so terminated under this clause the RailTel may at the time of such termination take over from the Contractor at prices as provided for in the contract, all works executed or works under execution.
- 4.12. Representation on Works** – The Contractor shall, when he is not personally present on the site of the works place, keep a responsible agent at the works during working hours who shall, on receiving reasonable notice, present himself to the Regional General Manger/RailTel and orders given by the Engineer or the Engineer's Representative to the agent shall be deemed to have the same force as if they had been given to the Contractor. Before absenting himself, the Contractor shall furnish the name and address of his agent for the purpose of this clause and failure on the part of the Contractor to comply with this provision at any time will entitle the RailTel to rescind the contract under Para 4.62 of these conditions.
- 4.13. Relics and Treasures** – All gold, silver, oil and other minerals of any description and all precious stones, coins, treasures, relics, antiquities and other similar things which shall be found in or upon the site shall be property of the RailTel and the Contractor shall duly preserve the same to the satisfaction of

the RailTel and shall from time to time deliver the same to such person or persons as the RailTel may appoint to receive the same.

- 4.14. Excavated material** – The Contractor shall not sell or otherwise dispose of or remove except for the purpose of this contract, the sand, stone, clay ballast, earth, rock or other substances or materials which may be obtained from any excavation made for the purpose of the works or any building or produced upon the site at the time of delivery of the possession thereof but all the substances, materials, buildings, and produce shall be the property of the RailTel provided that the Contractor may, with the permission of the Regional General Manger/RailTel, use the same for the purpose of the works either free of cost or pay the cost of the same at such rates as may be determined by the Engineer.
- 4.15. Indemnity by Contractors** – The Contract shall indemnify and save harmless the RailTel from and against all actions, suit proceedings, losses, costs, damages, charges, claims, and demands of every nature and description brought or recovered against the RailTel by reason of any act or omission of the Contractor, his agents or employees, in the execution of the works or in his guarding of the same. All sums payable by way of compensation under any of these conditions shall be considered as reasonable compensation to be applied to the actual loss or damage sustained, and whether or not any damage shall have been sustained.
- 4.16 Security Deposit**
Refer para 5.3 of chapter 5 (special conditions of contract) of tender document.
- 4.17. Completion Period**
- 4.17.1 Subject to any requirement in the contract as to completion of any portion or portions of the works before completion of the whole, the contractor shall fully and finally complete the whole of the works comprised in the contract (with such modifications as may be directed under conditions of this contract) by the date entered in the contract or extended date in terms of the following clauses:
- 4.17.1.1 If any modifications have been ordered which in the opinion of the Engineer have materially increased the magnitude of the work, then such extension of the contracted date of completion may be granted as shall appear to the Engineer to be reasonable in the circumstances, provided moreover that the Contractor shall be responsible for requesting such extension of the date as may be considered necessary as soon as the clause thereof shall arise and in any case not less than one month before the expiry of the date fixed for completion of the works.
- 4.17.1.2 If in the opinion of the Engineer the progress of work has any time been delayed by any act or neglect of RailTel's employees or by other contractor employed by the RailTel under Para 4.20.4 of these conditions or in executing the work not forming part of the contract but on which contractor's performance necessarily depends or by reason of proceeding taken or threat-tended by or dispute with adjoining or neighboring owners or public authority arising otherwise through the Contractor's own default etc. or by the delay authorized by the Engineer pending arbitration or in consequences of the contractor not

having received in due time necessary instructions from the RailTel for which he shall have specially applied in writing to the Engineer or his authorized representative then, upon happening of any such event causing delay, the contractor shall immediately give notice thereof in writing to the Engineer within 15 days of such happening but shall nevertheless make constantly his best endeavors to bring down or make good the delay and shall do all that may be reasonably required of him to the satisfaction of the Engineer to proceed with the works. The contractor may also indicate the period for which the work is likely to be delayed and shall be bound to ask for necessary extension of time. The engineer on receipt of such request from the contractor shall consider the same and shall grant such extension of time as in his opinion is reasonable having regard to the nature and period of delay and the type and quantum of work affected thereby. No other compensation shall be payable for works so carried forward to the extended period of time, the same rates, terms and conditions of contract being applicable as if such extended period of time was originally in the original contract itself.

- 4.17.1.3 In the event of any failure or delay by the RailTel to hand over the Contractor possession of the lands necessary for the execution of the works or to give the necessary notice to commence the works or to provide the necessary drawings or instructions or any other delay caused by the RailTel due to any other cause whatsoever, then such failure or delay shall in no way affect or vitiate the contract or alter the character thereof or entitle the contractor to damages or compensation therefore but in any such case, the RailTel may grant such extension or extensions of the completion date as may be considered reasonable.
- 4.17.2 Extension of time for delay due to contractor – The time for the execution of the work or part of the works specified in the contract documents shall be deemed to be the essence of the contract. If the contractor fails to complete the works within the time as specified in the contract for the reasons other than the reasons specified in Para 4.11 and 4.17.1 above, the RailTel may, if satisfied that the works can be completed by the contractor within reasonable short time thereafter, allow the contractor further extension of time as the Engineer may decide. On such extension the RailTel will be entitled without prejudice to any other right and remedy available on that behalf, to recover from the contractor as agreed damages and not by way of penalty a sum equivalent to 1/2% of the contract value of the works for each week or part of the week for a period up to ten weeks and thereafter at the rate of 0.7% for each week of delay or part thereof for another ten weeks subject to a maximum of 12% of the contract value.
- 4.17.2.1 For the purpose of this clause, the contract value of the works shall be taken as value of work as per contract agreement including any supplementary work order/contract agreement issued. Provided also, that the total amount of liquidated damages under this condition shall not exceed 12% of the total value of the contract. Provided further, that if the RailTel is not satisfied that the works can be completed by the Contractor and in the event of failure on the part of the contractor to complete the work within further extension of time allowed as aforesaid, the RailTel shall be entitled, without prejudice to any other right or remedy available in that behalf, to appropriate the contractor's security deposit

and rescind the contract under Para 4.62 of these conditions, whether or not actual damage is caused by such default.

4.18. Illegal Gratification

- 4.18.1 Any bribe, commission, gift or advantage given, promised or offered by or on behalf of the Contractor or his partner, agent or servant or anyone on his behalf, to any officer or employees of the RailTel, or to any person on his behalf in relation to obtaining or the execution of this or any other contract with the RailTel shall, in addition to any criminal liability which he may incur, subject the contractor to the rescission of the contract and all other contracts with the RailTel and to the payment of any loss or damage resulting from such decision and the RailTel shall be entitled to deduct the amounts so payable from any moneys due to the Contractor (s) under this contract or any other contracts with the RailTel.
- 4.18.2 The Contractor shall not lend or borrow from or have or enter into any monetary dealings or transactions either directly or indirectly with any employee of the RailTel and if he shall do so, the RailTel shall be entitled forthwith to rescind the contract and all other contracts with the RailTel. Any question or dispute as to the commission or any offence or compensation payable to the RailTel under this clause shall be settled by the Executive Director of RailTel, in such a manner as shall consider fit and sufficient and his decision shall be final and conclusive. In the event of rescission of the contract under this clause, the Contractor will not be paid any compensation whatsoever except payments for the work done up-to-date of rescission.

4.19. Execution of Works

- 4.19.1 Contractor's understanding – It is understood and agreed that the Contractor has, by careful examination, satisfied himself as to the nature and location of the work, the conformation of the ground, the character, quality and quantity of the materials to be encountered, the character of equipment and facilities needed preliminary to and during the progress of the works, the general and local conditions, the labour conditions prevailing therein and all other matters which can in any way affect the works under the contract.
- 4.19.2 Commencement of works – The Contractor shall commence the works within 15 days after the receipt by him of an order in writing to this effect from the RailTel and shall proceed with the same with due expedition and without delay. The work should be started with due intimation to RailTel.
- 4.19.3 Accepted programme of work
- The Contractor who has been awarded the work shall as soon as possible but not later than 7 days from the date of receipt of the acceptance letter in respect of contracts with initial completion period of one year or less or not later than 15 days for other contracts have to submit the detailed programme of work indicating the time schedule of various items of works in the form of Bar Chart/PERT/CPM. He shall also submit the details of organization (in terms of labour and supervisors) plant and machinery that he intends to utilize (from time to time) for execution of the work within stipulated date of completion. The programme of work amended as necessary by discussions with the Engineer,

shall be treated as the agreed programme of the work for the purpose of this contract and the contractor shall and endeavor to fulfill this programme of work. The progress of work will be watched accordingly and the liquidated damages will be with reference to the overall completion date. Nothing stated herein shall preclude the contractor in achieving earlier completion of item or whole of the works than indicated in the programme.

4.19.4 Setting out of works

The Contractor shall be responsible for the correct setting out of all works in relation to original reference at his cost. The Contractor shall execute the work true to specifications, drawings, plans and dimensions as mentioned in the contract document and as directed by the Engineer's representative and shall check these at frequent intervals. The Contractor shall provide all facilities like labour and instruments and shall cooperate with the Engineer's representative at all time, during the progress of the works. Any error shall appear or arise in any part of the work, the Contractor, on being required so to do by the Engineer's representative shall, at his own rectify such errors, to the satisfaction of the Engineer's representative. Such checking shall not absolve the Contractor of his own responsibility of maintaining accuracy in the work.

4.20. Compliance to Engineer's Instructions

4.20.1 The Engineer shall direct the order in which the several parts of the works shall be executed and the Contractor shall execute without delay all orders given by the Engineer from time to time but the Contractor shall not be relieved thereby from responsibility for the due performance of the works in all respects.

4.20.2 **Alterations to be authorized** – No alterations in or additions to or omissions or abandonment of any part of the works shall be deemed authorized, except under instructions from the Engineer, and the Contractor shall be responsible to obtain such instructions in each and every case in writing from the Engineer.

4.20.3 Extra Works

Should works over and above those included in the contract require to be executed at the site, the contractor shall have no right to be entrusted with the execution of such works, which may be carried out by another contractor or contractors or by other means at the sole discretion of the RailTel.

4.20.4 Separate Contracts in connection with works

The RailTel shall reserve the right to let other contracts in connection with the works. The Contractor shall afford other contractors reasonable opportunity for the storage of their materials and the execution of their works and shall properly connect and coordinate his work with theirs. If any part of the Contractor's work depends for proper execution or result upon the work of another contractor(s), the Contractor shall inspect and promptly report to the Engineer any defects in such works that render it unsuitable for such proper execution and results. The Contractor's failure so to inspect and report shall constitute as acceptance of the other contractor's work as fit and proper for the reception of his work, except as to defects which may develop in the other contractor's work after the execution of his work.

4.21. Instructions of Engineer's Representative

Any instructions or approval given by the Engineer's representative to Contractor in connection with the works shall bind the Contractor as though it had been given by the Engineer provided always as follows: -

- 4.21.1 Failure of the Engineer's representative to disapprove any work or materials shall not prejudice the power of the Engineer thereafter to disapprove such work or material and to order the removal or breaking up thereof.
- 4.21.2 If the Contractor shall be dissatisfied by reason of any decision of the Engineer's representative he shall be entitled to refer the matter to the Engineer who shall there upon confirm or vary such decision.

4.22. Adherence to specifications and drawings

- 4.22.1 The whole of the works shall be executed in perfect conformity with the specifications and drawings of the contract. If the Contractor performs any works in a manner contrary to the specifications or drawings or any of them and without such reference to the Engineer, he shall bear all the costs arising or ensuring there- from and shall be responsible for all loss to the RailTel.

4.22.2 Drawings and specifications on the works :

- 4.22.2.1 The contractor shall keep one copy of Drawings and specifications at the site, in good order, and such contract documents as may be necessary, available to the Engineer or the Engineer's Representative.
- 4.22.2.2 The supply of equipment and materials shall include supply of one set of printed documents from original equipment manufacturers with each equipment as given in technical supplement.
- 4.22.3 Ownership of Drawings and Specifications – All drawings and Specifications and copies thereof furnished by the RailTel to the Contractor are deemed to be the property of the RailTel. They shall not be used in another works and with the exception of the signed contract set, shall be returned by the Contractor to the RailTel on completion of the work or termination of the Contract.
- 4.22.4 Compliance with Contractor's request for details – The Engineer shall furnish with reasonable promptness, after receipt by him of the Contractor's request for the same, additional instructions by means of drawings or otherwise, necessary for the proper execution of the works or any part thereof. All such drawings and instructions shall be consistent with the Contract Documents and reasonably inferable there from.

4.22.5 Meaning and Intent of specification and drawings

If any ambiguity arises as to the meaning and intent of any portion of the Specifications and Drawings or as to execution or quality of any work or material, or as to the measurements of the works, the decision of the Engineer thereon shall be final subject to the appeal (within 7 days of such decision being intimated to the Contractor) to the competent authority in RailTel who

shall have the power correct any errors, omissions, or discrepancies in aforementioned items and whose decision in the matter in dispute or doubt shall be final and conclusive.

4.23. Working during night

The Contractor shall not carry out any work between sunset and sunrise without the previous permission of the Engineer. Hence, no “night duty” shall be payable to the contractor for the portion/part of the works to be undertaken during the night.

4.24. Damage to Govt/RailTel property or private life and property

The Contractor shall be responsible for all risk to the works and for trespass and shall make good at his own expense all loss or damage whether to the works themselves or any other property of the Railways/RailTel or the lives, persons or property of others from whatsoever cause in connection with the works until they are taken over by the RailTel and this although all reasonable and proper precautions may have been taken by the Contractor, and in case the RailTel shall be called upon to make good any costs, loss or damages, or to pay any compensation, including that payable under the provisions of the Workmen’s Compensation Act or any statutory amendments thereof to any person or persons sustaining damages as aforesaid by reason of any act, or any negligence or omissions on the part of the Contractor the amount of any costs or charges including costs and charges in connection with legal proceedings, which the RailTel may incur in reference thereto, shall be charged to the Contractor. The RailTel shall have the power and right to pay or to defend or compromise any claim of threatened legal proceedings or in anticipation of legal proceedings being instituted consequent on the action or default of the Contractor, to take such steps as may be considered necessary or desirable to ward off or mitigate the effect of such proceedings, charging to Contractor, as aforesaid, any sum or sums of money which may be paid and any expenses whether for reinstatement or otherwise which may be incurred and the propriety of any such payment, defense or compromise, and the incurring of any such expenses shall not be called in question by the Contractor.

4.25. Sheds, Stores houses and Yards

The Contractor shall at his own expense provide himself with sheds, storehouses and yards in such situations and in such numbers as in the opinion of the Engineer is requisite for carrying on the works and the Contractor shall keep at each such sheds, store houses and yards a sufficient quantity of materials and plant in stock so as not to delay the carrying out of the works with due expedition and the Engineer and the Engineer’s representative shall have free access to the said sheds, store houses and yards at any time for the purpose of inspecting the stock of materials or plant so kept in hand, and any materials or plant which the Engineer may object to shall not be brought upon or used in the works, but shall be forthwith removed from the sheds, store houses or yards by the contractor. The Contractor shall at his own expenses provide and maintain suitable mortar mills, soaking vats or any other equipments necessary for the execution of the works.

4.26. Provision of efficient and competent staff

The Contractor shall place and keep on the works at all times efficient and competent staff to give the necessary directions to his workmen and to see that they execute their work in sound and proper manner and shall employ only such supervisors, workmen and labourers in or about the execution of any of these works as are careful and skilled in various trades and callings. The Contractor shall at once remove from the works any agents, permitted sub-contractor, supervisor, workman or labourer who shall be objected to by the Engineer and if and whenever required by the Engineer, he shall submit a correct return showing the names of all staff and workmen employed by him. In the event of the Engineer being of the opinion that the Contractor is not employing on the works a sufficient number of staff and workmen as is necessary for the proper completion of the works within the time prescribed, the Contractor shall forthwith on receiving intimation to this effect take on the additional number of staff and labour specified by the Engineer within seven days of being so required and failure on the part of the Contractor to comply with such instructions will entitle the RailTel to rescind the contract under Para 4.62 of these conditions.

4.27. Workmanship and Testing

- 4.27.1 The whole of the works and/or supply of materials specified and provided in the contract or that may be necessary to be done in order to form and complete any part thereof shall be executed in the best and most substantial workman like manner with materials of the best and most approved quality of their respective kinds, agreeable to the particulars contained in or implied by the specifications and as referred to in and represented by the drawings or in such other additional particulars. Instructions and drawings may be found requisite to be given during the carrying on of the works and to the entire satisfaction of the Engineer according to the instructions and directions, which the Contractors may from time to time receive from the Engineer. The materials may be subjected to tests by Mean of such machines, instruments and appliances as the Engineer may direct and wholly at the expense of the Contractor.
- 4.27.2 Removal of Improper work and materials – The Engineer or the Engineer’s representative shall be entitled to order from time to time.
- 4.27.2.1 The removal from the site within the time specified in the order of any materials, which in his opinion are not in accordance with the specifications or drawings.
- 4.27.2.2 The substitution of proper and suitable materials, and
- 4.27.2.3 The removal and proper re-execution, notwithstanding any previous tests thereof or “on account” payments therefore, of any work which in respect of materials or workmanship is not in his opinion in accordance with the specifications and in case of default on the part of the Contractor in carrying out such order the RailTel shall be entitled to rescind the contract under Para 4.62 of tender document of these conditions.

4.28. Facilities for Inspection

The Contractor shall afford the Engineer and the Engineer's Representative every facility for entering in and upon every portion of the work at all hours for the purpose of inspection or otherwise and shall provide all labour, materials, instruments, appliances and things of every kinds required for the purpose and the Engineer and the Engineer's representative shall at all time have free access to every part of the works and to all places at which materials for the work are stored or being prepared.

4.29. Examination of work before covering up

The Contractor shall give two days notice to the Engineer or the Engineer's Representative whenever any work or materials are intended to be covered up in the earth, in bodies or walls or otherwise to be placed beyond the Reach of Measurements in order that the work may be inspected or that correct dimension may be taken before being so covered, placed beyond the reach of measurement in default whereof, the same shall at the option of the Engineer or the Engineer's Representative be uncovered and measured at the contractor's expense or no allowance shall be made for such work or materials.

4.30. Temporary works

All Temporary works necessary for the proper execution of the works shall be provided and maintained by the Contractor and subject to the consent of the Engineer, shall be removed by him at his expenses when they are no longer required and in such manner as the Engineer shall direct. In the event of failure on the part of the Contractor to remove the temporary works, the Engineer will cause them to be removed and cost as increased by supervision and other incidental charge shall be recovered from the Contractor. If temporary huts are provided by the Contractor on the RailTel/Railway land for labour engaged by him and the work is completed but the contractor's labour refused to vacate and have to be removed by the RailTel, necessary expenses incurred by the RailTel in connection therewith shall be borne by the Contractor.

4.31. Contractor to supply water for works

4.31.1 Unless otherwise provided in the contract, the contractor shall be responsible for arrangements to obtain supply of water for the works.

4.31.2 Contractor to arrange supply of Electric power for works.

4.31.3 Electric supply from the Railway system

The RailTel may supply to the Contractor part or whole of the electric power wherever available and possible, required for execution of works from the Railway's existing electric supply systems at or near the site of works on specified terms and conditions and such charges as shall be determined by the RailTel and payable by the contractor provided the cost of arranging necessary connection to the Railway's Electric supply systems, and laying of underground/overhead conducts circuit protection, electric power meters, transmission structure, shall be borne by the Contractor and that the

contractor shall not be entitled to any compensation or reason for delay for interruption or failure of the Electric supply system.

4.32. Property in material and Plants: Deleted

4.33. Tools, Plant and Materials Supplied by the RailTel

4.33.1 Not used.

4.33.1 Hire of RailTel's Plant: Deleted.

4.34. Precaution during progress of work

4.34.1 During the execution of works, unless otherwise specified the Contractor shall at his own cost provide the materials for and execute all shoring, timbering and strutting works as is necessary for the stability and safety of all structures, excavations and works and shall ensure that no damage, injury, loss is caused or likely to be caused to any person or property.

4.34.2 Roads and water courses: Existing roads or water courses shall not be blocked, cut through, altered, diverted or obstructed in any way by the Contractor, except with the permission of the Engineer. All compensations claimed for any authorized closure, or his agent or his staff shall be recoverable from the Contractor by deduction from any sums which may become due to him in terms of contract or otherwise according to law.

4.34.3 Provision of access to premises: During progress of work in any street or thoroughfare, the Contractor shall make adequate provision of the passage of traffic, for securing safe access to all premises approached from such street or thoroughfare and for any drainage, water supply or meant for lightning which may be interrupted by reason of the execution of the works and shall react and maintain at his own cost barriers, lights and other safeguards as prescribed by the Engineer, for the regulation of the traffic, and provide watchmen necessary to prevent accidents. The works shall in such cases be executed night and day if so ordered by the Engineer and with such vigour so that the traffic way be impeded for as short a time as possible.

4.34.4 Safety of Public: The Contractor shall be responsible to take all precautions to ensure the safety of the public or Railway/RailTel's property and shall post such look out men as may in the opinion of the Engineer be required to comply with regulations pertaining to the work.

4.35. Use of Explosives

Explosive shall not be used on the works or on the site by the Contractor without the permission of the Engineer and then only in the manner and to the extent to which such permission is given. Where explosives are required for the works, the same shall be stored in a special magazine to be provided by and at the cost of the Contractor in accordance with the Explosive Rules. The Contractor shall obtain the necessary license for the storage and the use of explosives and all operations in which or for which explosives are employed shall be at the sole risk and responsibility of the Contractor and the Contractor shall indemnify the Railway/RailTel in respect thereof.

4.36 Suspension of works

4.36.1 The Contractor shall on the order of Engineer suspend the progress of the works or any part thereof for such time or times and in such manner as the Engineer may consider necessary and shall during such suspension properly protect and secure the work so far as is necessary in the opinion of the Engineer. If such suspension is: -

- (a) Provided for in the contract, or
- (b) Necessary for the proper execution of the works or by the reason of act of God or by some default on the part of the Contractor, and or
- (c) Necessary for the safety of the works or any part thereof.

4.36.2 The Contractor shall not be entitled to the extra costs, if any, incurred by him during the period of suspension of the works; but in the event of any suspension ordered by the Engineer for reasons other than aforementioned and when each such period of suspension exceeds 14 days, the Contractor shall be entitled to such extension of time for completion of the works as the engineer may consider proper having regard to the period or periods of such suspensions and to such compensations as the Engineer may consider reasonable in respect of salaries or wages paid by the Contractor to his employees during the periods of such suspensions.

4.36.3 Suspension lasting more than 3 month – If the progress of the works or any part thereof is suspended on the order of the Engineer for more than three months at a time, the Contractor may serve a written notice on the Engineer requiring permission within 15 days from the receipt thereof to proceed with the works or that part thereof in regard to which progress is suspended and if such permission is not granted within that time the Contractor by further written notice so served may, but is not bound to, elect to treat the suspension where it affects part only of the works as an omission of such part or where it affects the whole of the works, as an abandonment of the contract by the RailTel.

4.37 Rates for items of works

The rates entered in the accepted Schedule Of Requirements of the Contract are intended to provided for works duly and properly completed in accordance with the general and special conditions of the contract and the specifications and drawings together with such enlargements, extensions, diminutions, reductions, alterations or additions as may be ordered in terms of Para 4.42 of these conditions and without prejudice to the generality thereof and shall be deemed to include and cover superintendence and labour, supply including full freight of materials, stores, tools and all apparatus and plant required on the works, except such tools, plant or materials as may be specified in the contract to be supplied to the Contractor by the RailTel, the erection, maintenance and removal of all temporary works and buildings, all arrangements for the safety of the public or of employees during the execution of works, all sanitary and medical arrangements for labour camps as may be prescribed by the RailTel, the setting of all work and of the construction, repair and upkeep of all center lines, bench marks and level pegs thereon, site clearance, all fees, duties, royalties, rent and compensation to owners for

surface damage or taxes and impositions payable to local authorities in respect of land, structures and all material supplied for the work or other duties or expenses for which the Contractor may become liable or may be put to under any provision of law for the purpose of or in connection with the execution of the contract, and all such other incidental charges or contingencies as may have been specially provided for in the specifications.

4.38 Demurrage and wharfage dues

4.38.1 Demurrage charges calculated in accordance with the scale in force for the time being on the RailTel and incurred by the Contractor failing to load or unload any goods or materials within the time allowed by RailTel for loadings as also wharfage charges, of materials not removed in time as also charges due on consignments booked by or to him shall be paid by the Contractor, failing which such charges shall be debited to the Contractor's account in the hands of the RailTel and shall be deducted from any sums which may become due to him in terms of the contracts.

4.39 Rates for extra items of works

4.39.1 Any item of work carried out by the Contractor on the instructions of the Engineer which is not included in the accepted schedule of rates shall be executed at the rates set forth in the "Schedule Of Requirements" modified by the tender percentage and such items are not contained in the latter, at the rate agreed upon between the Engineer and the Contractor before the execution of such items of work and the contractors shall be bound to notify the Engineer at least seven days before the necessity arises for the execution of such items of works that the accepted Schedule Of Requirements does not include rate or rates for the extra work involved. The rates payable for such items shall be decided at the meeting to be held between the Engineer and Contractor, in as short a period as possible after the need for the special item has come to the notice. In case the Contractor fails to attend the meeting after being notified to do so or in the event of no settlement being arrived at, the RailTel shall be entitled to execute the extra works by other means and the contractor shall have no claim for loss or damage that may result from such procedure.

4.39.2 Provided that if the Contractor commences work or incurs any expenditure in regard thereto before the rates as determined and agreed upon as lastly hereunto fore mentioned, then and in such a case the Contractor shall only be entitled to be paid in respect of the work carried out or expenditure incurred by him prior to the date of determination of the rates as aforesaid according to the rates as shall be fixed by the Engineer. However if the contractor is not satisfied with the decision of the Engineer in this respect he may appeal to the competent authority of RailTel within 30 days of getting the decision of the Engineer, supported by analysis of the rates claimed. The competent authority of RailTel's decision after hearing both the parties in the matter would be final and binding on the Contractor.

4.40 Handing over of works

4.40.1 The Contractor shall be bound to hand over the works executed under the contract to the RailTel complete in all respect to the satisfaction of the Engineer. The Engineer shall determine the date on which the work is

considered to have been completed, in support of which his certificate shall be regarded as sufficient evidence for all purposes. The engineer shall determine from time to time, the date on which any particular section of the work shall have been completed, and the contractor shall be bound to observe any such determination of the Engineer.

4.40.2 Clearance of Site on Completion: On completion of the works the contractor shall clear away and remove from the site all constructional plant, surplus material, rubbish and temporary works of every kind and leave whole of the site and works clean and in a workman like condition to the satisfaction of the Engineer. No final payment in settlement of the accounts for the work shall be paid, held to be due or shall be made to the contractor till, in addition to any other condition necessary for such final payment, site clearance shall have been affected by him, and such clearance may be made by the Engineer at the expense of the Contractor in the event of his failure to comply with this provision within 7 days after receiving notice to that effect. It Should become necessary for the Engineer to have the site cleared at the expense of the Contractor, the RailTel shall not be held liable for any loss or damage to such of the Contractor's property as may be on the site and due to such removal there from which removal may be affected by means of public sales of such materials and property or in such a way as deemed for and convenient to the Engineer.

4.41 Variations in Extent of Contract

4.41.1 Modification to Contract to be in writing – In the event of any of the provisions of the Contract requiring to be modified after the contract documents have been signed, the modifications shall be made in writing and signed by the RailTel and the Contractor, and no work shall proceed under such modifications until this has been done. Any verbal or written arrangement abandoning, modifying, extending, reducing or supplementing the Contract or any of the terms thereof shall be deemed conditional and shall not be binding on the RailTel unless and until the same is incorporated in a formal instrument and signed by the RailTel and the Contractor and till then the RailTel shall have the right to repudiate such arrangement.

4.42 Powers of Modification to Contract

4.42.1 The Engineer on behalf of the RailTel shall be entitled by order in writing to enlarge or extend, diminish or reduce the works or make any alterations in their design, character, position, site quantities, dimensions or in the method of their execution or in the combination and use of materials for the execution thereof or to order any additional work to be done or any works not to be done and the Contractor will not be entitled to any compensation for any increase / reduction in the quantities of work but will be paid only for the actual amount of work done and for approved materials supplied against a specific order.

4.42.2 Unless otherwise specified in the special conditions of the contract, the accepted variation in quantity for each individual item of the contract would be up to $\pm 25\%$ of the quantity originally contracted. The contractor shall be bound to carry out the work at the agreed rates and shall not be entitled to any claim or any compensation, whatsoever upto the limit of $\pm 25\%$ variation in quantity of individual items of works. In case of increase in quantity of an individual

item by more than 25% of agreement quantity, for variation above 25% and up to 40%, the agreed SOR rate will be reduced by 2% and for variation beyond 40% and up to 50%, the agreed SOR rate will be reduced by 4%, For variation beyond 50%, the rate shall be negotiated for additional quantity in excess of 50% of agreement quantity.

4.42.3 **Valuation of Variations** – The enlargements, extensions, diminution, reduction, alterations or additions referred to in Para 4.42.2 this clause shall in no degree affect the validity of the contract but shall be performed by the Contractor as provided therein and be subject to the same conditions, stipulations and obligations as if they had been originally and expressively included and provided for in the specifications and drawings and the amounts to be paid therefore shall be calculated in accordance with the accepted Schedule Of Requirements. Any extra items/quantities of work falling outside the purview of the provisions of Para 4.42.2 above shall be paid for at the rates determined under Para 4.39 of these conditions.

4.43. **Claims**

4.43.1 **Monthly Statement of Claims** - The contractor shall prepare and furnish to the Engineer once in every month an account giving full and detailed particulars of all claims for any additional expenses to which the Contractor may consider himself entitled to and of all extra or additional works ordered by the Engineer which he has executed during the preceding month and no claim for payment for and such work will be considered which has not been included in such particulars.

4.43.2 **Signing of “No Claim” Certificate** – The Contractor shall not be entitled to make any claim whatsoever against the RailTel under or by virtue of or arising out of this contract, nor shall the RailTel entertain or consider any such claim, if made by the Contractor, after he shall have signed a ‘No Claim’ certificate in favour of the RailTel, in such form as shall be required by the RailTel, after the works are finally measured up. The Contractor shall be debarred from disputing the correctness of the items covered by “No Claim Certificate” or demanding a preference to arbitration in respect thereof.

4.44. **MEASUREMENTS, CERTIFICATES AND PAYMENTS**

Qualities in schedule annexed to Contract- The quantities set out in the accepted Schedule of Requirements with items of works quantified are the estimated quantities of the works and they shall not be taken as the actual and correct quantities of the works to be executed by the Contractor in fulfillments of his obligations under the contract.

4.45. **Measurements of Works:** The Contractor shall be paid for the works at the rates in the accepted Schedule Of Requirements and for extra works at rates determined under Para 4.39 of these conditions on the measurements taken by the Engineer or the Engineer’s representative in accordance with the rules prescribed for the purpose by the RailTel. The quantities for items the unit of which in the accepted Schedule Of Requirements is 100 or 1000 shall be calculated to the nearest whole number, any fraction below half being dropped and half and above being taken as one; for item the unit of which in the accepted Schedule Of Requirements is single, the quantities shall be

calculated to places of decimals. Such measurements will be taken of the work in progress from time to time and at such intervals as in the opinion of the Engineer shall be proper having regard to the progress of works. The date and time on which "on account" or final measurements are to be made shall be communicated to the Contractor who shall represent at the site and shall sign the results of the measurements (which shall also be signed by the Engineer or the Engineer's representative) recorded in the official measurements book as an acknowledgement of his acceptance of the accuracy of the measurements. Failing the Contractor's attendance the work may be measured up in his absence and such measurements shall, notwithstanding such absence, be binding upon the Contractor whether or not he shall have signed the measurement book provided always that any objection made by him to measurement shall be duly investigated and considered in the manner set out below:

- (a) It shall be open to the Contractor to take specific objection to any recorded measurements or Classification on any ground within seven days of the date of such measurements. Any re-measurement taken by the Engineer or the Engineer's representative in the presence of the Contractor or in his absence after due notice has been given to him in consequences of objection made by the contractor shall be final and binding on the Contractor and no claim whatsoever shall thereafter be entertained regarding the accuracy and classification of the measurement.
- (b) If an objection raised by the Contractor is found by the Engineer to be incorrect, the Contractor shall be liable to pay the actual expenses incurred in measurements.

4.46 "On-Account" Payments

- 4.46.1 The Contractor shall be entitled to be paid from time to time by way of "On-Account" payment only for such works as in the opinion of the Engineer he has executed in terms of the contract. All payments due on the Engineer's or the Engineer's Representative's certificates of measurements shall be subject to any deductions which may be made under these presents and shall further be subject to, unless otherwise required by Para 4.16 of these conditions, a retention of ten percent by way of security deposits, until the amount of security deposit by way of retained earnest money and such retentions shall amount to 5% of the total value of the contract provided always that the Engineer may by any certificate make any correction or modification in any previous certificate which shall have been issued by him and that the Engineer may withhold any certificate if the works or any part thereof are not being carried out to his satisfaction.
- 4.46.2 Rounding off amounts: The total amount due shall be rounded off to the nearest rupee i.e. sums less than 50 paise shall be omitted and sums of 50 paise and more upto Rs. 1/- will be reckoned as Rs. 1/-.

Undertaking

4.46.3 On-Account Payments not prejudicial to final settlements: "On Account" payments made to the Contractor shall be without prejudice to the final making up of the accounts (except where measurements are specifically noted in the Measurement Book as "Final Measurements" and as such have been signed by the Contractor) and shall in no respect be considered or used as evidence of any facts stated in or to be inferred from such account not of any particular quantity of work having been executed nor of the manner of its execution being satisfactory.

4.46.4 Manner of payment: Unless otherwise specified payments to the Contractor will be made through RTGS.

4.47. Maintenance of works:

The contractor shall at all times during the progress and continuance of the works and also for the period of warranty specified in the tender form and after the date of passing of the certificate of completion by the Engineer or any earlier date subsequent to the completion of the works that may be fixed by the Engineer be responsible for and effectively maintain and uphold in good substantial sound and perfect conditions all and every part of the work and shall make good from time to time and at all times as often as the Engineer shall require. Any damage or defect that may during the above period arise in or be discovered or be in any way connected with the works, provided that such damage or defect is not directly caused by errors in the contract documents, act of providence or insurrection or civil riot, and the Contractor shall be liable for and make good to the RailTel or other persons legally entitled thereto whenever required by the Engineer so to do, all losses, damage, costs and expenses they or any of them may incur or be put or be liable, by reason or in consequence of the operations of the contractor or of his failure in any respect. For this purpose the tenderer will submit their strategy for providing maintenance support including the staff that will be available along with the set of spares for attending to various faults/problems during maintenance period.

4.48 Certificate of Completion of works

4.48.1 As soon as in the opinion of the Engineer the works shall have been substantially completed in the whole block and has satisfactorily passed any final test or tests that may be prescribed, the Engineer shall issue a Provisional Acceptance Certificate in respect of the works and period of warranty shall commence from the date of issue of Last Provisional Acceptance Certificate and completion of the work of whole Block. Minor defects pointed out while issuing PACs shall be attended by the contractor within reasonable period of time to the satisfaction of Engineer.

4.48.2 Contractor not absolved by Provisional completion Certificate (PAC): The Certificate of completion in respect of the works referred to in Para 4.48.1 of this clause shall not absolve the Contractor from his liability to make good any defect, imperfection, shrinkages or faults which may appear during the period of maintenance specified in the tender arising in the opinion of the Engineer from materials or workmanship not in accordance with the drawing or specifications or instructions of the Engineer, which defect, imperfections,

shrinkages or faults shall upon the direction in writing of the Engineer, be amended and made good by the Contractor at his own cost; and in case of default on the part of Contractor the Engineer may employ, labour and material or appoint another Contractor to amend and make good such defect, imperfections, shrinkages and faults and all expenses consequent thereon and incidental thereto shall be borne by the Contractor and shall be recoverable from any moneys due to him under the contract.

4.49. Approval only by Final Acceptance Certificate (FAC)

No certificate other than Final Acceptance Certificate referred to in Para 4.50 of the conditions shall be deemed to constitute approval of any work or other matter in respect of which it is issued or shall be taken as an admission of the due performance of the contract or any part thereof or of the accuracy of any demand made by the Contractor or of additional varied work having been ordered by the Engineer nor shall any other certificate conclude or prejudice any of the powers of the Engineers.

4.50. Final Acceptance Certificate:

4.50.1 The contract shall not be considered as completed until a Final Acceptance Certificate shall have been signed by the Engineer stating that the works have been completed and maintained to this satisfaction. The warranty certificate shall be given by the Engineer upon the expiration of the period of or as soon thereafter as any work ordered during such period pursuant to Para 4.48.2 of these conditions shall have been completed to the satisfaction of the Engineer and full effect shall be given to this Clause notwithstanding the taking possession of or using the works or any part thereof by the RailTel.

4.50.2 **Cessation of RailTel's Liability:** The RailTel shall not be liable to the Contractor for any matter arising of or in connection with the contract of the execution of the works unless the Contractor shall have made a claim in writing in respect thereof before the issue of the Maintenance Certificate (FAC) under this clause.

4.50.3 **Unfulfilled obligations** - Notwithstanding the issue of the Maintenance Certificate the Contractor and (subject to Para 4.50.2) RailTel shall remain liable for the fulfillment of any obligation incurred under the provision of the contract prior to the issue of the maintenance Certificate which remains unperformed at the time such certificate is issued and for the purposes of determining the nature and extent of any such obligations the contract shall be deemed to remain in force between the parties thereto.

4.51. Final payment

4.51.1 On the Engineer's certificate of completion in respect of the works an adjustment shall be made and the balance of account based on the Engineer or the Engineer's representative's on the accepted schedule or rates and for extra works on rates determined under Para 4.39 of these conditions shall be paid to the Contractor subject always to any deduction which may be made under these presents and further subject to the Contractor having delivered to

the Engineer either a full account in detail of all claims he may have on the RailTel in respect of the works or having delivered "No Claim" Certificate and the Engineer having after the receipt of such account given a certificate in writing that such claim are correct, that the whole of the works to be done under the provisions of the Contracts have been completed, that they have been inspected by him since their completion and found to be in good and substantial order, that all properties, works and things removed, disturbed or injured in consequence of the works have been property replaced and made good and all expenses and demands incurred by or made upon the RailTel for or in the respect of damage or good and all expenses and demands incurred by or made upon the RailTel for or in the respect of damage or good and all expenses and demands incurred by or made upon the RailTel for or in the respect of damage or loss by from kin consequence of the works, have been satisfied agreeably and in conformity with the contract.

4.51.2 **Post payment Audit** – It is an agreed term of contract that the RailTel reserves to itself the right to carry out a post-payment audit and or technical examination of the works and the final bill including all supporting vouchers, abstracts, etc., and to make a claim on the contractor for the refund any excess amount paid to him if as a result of such examination any over-payment to him is discovered to have been made in respect of any work done or alleged to have been done by him under the contract.

4.51.3 **Refund of PBG** –

The Performance bank Guarantee (PBG) shall be released after a period of 12 months & issue of Final Acceptance Certificate commencing immediately after completion of the work in all the schedules, which will be enforceable by RailTel provided that all the stipulations of the clause have been fulfilled by the Contractor and all claim and demands made against the RailTel for and in respect of damage or loss by, from or in consequence of the works have been finally satisfied, provided further that in the event of different maintenance periods having become applicable to different parts of the works pursuant to Para 4.48.1 of these condition, the expression "expiration of the period of warranty" shall for the purpose of this clause, be deemed to mean the expiry of the latest of such periods.

In case of AMC ,PBG for maintenance shall be released after "satisfactory completion of maintenance period of one year.

4.51.4 **Production of vouchers etc. by the Contractor**

- (i) For a contract of more than one crore of rupees, the contractor shall, whenever required, produce for examination by the Engineer any quotation, invoice, cost or other account, book of accounts, voucher, receipt letter, memorandum, paper of writing or any copy of or extract from any such document and also furnish information and returns verified in such manner as may be required in any way relating to the execution of this contract or relevant for verifying or ascertaining cost of execution of this contract (the decision of the Engineer on the question of relevancy of any documents, information or return being final and binding on the parties.) The contractor

shall similarly produce vouchers, etc., if required to prove to the Engineer, that materials supplied by him, are in accordance with the specifications laid down in the contract.

- (i) If any portion of the work in a contract of value more than one crore of rupees be carried out by the a sub -contractor or any subsidiary or allied firm or company (as per Para 4.7 of the General Conditions of Contract), the Engineer shall have power to secure the book of such sub-contract or any subsidiary or allied firm or company, through the contractor, and such book shall be open to his inspection.
- (iii) The obligations imposed by Para 4.51.4 (i) and (ii) above is without prejudice to the obligations of the contractor under any statute rules or orders binding on the contractor.

4.52. Withholding and lien in respect of sums claimed

Whenever any claim or claims for payment of a sum of money arises out of or under the contract against the contractor, the RailTel shall be entitled to withhold and also have a lien to retain such sum or sums in whole or in part from the security, if any, deposited by the contractor and for the purpose aforesaid, the RailTel shall be entitled to withhold the said security deposit or the security if any, furnished as the case may be and also have a lien over the same pending finalization or adjudication of any such claim. In the event of the security being insufficient to cover the claimed amount or amounts or if no security has been taken from the contractor, the RailTel shall be entitled to withhold and have a lien to the extent of the such claimed amount or amounts referred to supra from any sum or sums found payable or which at any time thereafter may become payable to the contractor under the same contract or any other contract with this or any other RailTel or any Department of the Central Government pending finalization or adjudication of any such claim. It is an agreed term of the contract that the sum of money or moneys so withheld or retained under the lien referred to above, by the RailTel's will be kept withheld or retained as such by the RailTel till the claim arising out of or under the contract is determined by the arbitrator (if the Contract is covered by the arbitration clause) or by the competent court as the case may be and that the contractor will have no claim for interest or damages whatsoever on any account in respect of such withholding or retention under the lien referred to supra and duly notified as such to the contractor. For the purpose of this clause, where the contractor is a partnership firm or a limited company, the RailTel shall be entitled to withhold and also have a lien to retain towards such claimed amount or amounts in whole or in part from any sum found payable to any partner/limited company, as the case may be whether in his individual capacity or otherwise.

- 4.52.1 **Lien in respect of claims in Other Contracts** – Any sum of money due and payable to the contractor (Including the security deposit returnable to him) under the contract may be withheld or retained by way of lien by the RailTel, against any claim of this or any other RailTel or any other Department of the Central Government in respect of payment of a sum of money arising out of or under any other contract made by the contractor with this or any other

Department of Central Government. It is an agreed term of the contract that the sum of money so withheld or retained under this clause by the RailTel will be kept withheld or retained as such by the RailTel till the Claim arising out of or under any other contract is either mutually settled or determined by arbitration, if the other contract is governed by arbitration clause or by the competent court as the case may be and contractor shall have no claim for interest of money withheld or retained under this clause and duly notified as such to the contractor.

4.53. Signature on Receipts for Amounts

Every receipt which may become payable or for any security which may become transferable to the Contractors under these presents, shall, if signed in the partnership name by any one of the partners of a Contractors firm be a good and sufficient discharge to the RailTel in respect of the moneys or security purported to be acknowledged thereby and in the event of death of any of the Contractor partners during the pendency of the contract it is hereby expressly agreed that every receipt by any one of the surviving Contractor partners shall if so signed as aforesaid be good and sufficient discharge as aforesaid provided that nothing in this clause contained shall be deemed to prejudice or effect any claim which the RailTel may hereafter have against the legal representative of any contractor partner so dying, for or in respect of any breach of any of the conditions of the contract, provided also, that nothing in this clause contained shall be deemed to prejudice or effect the respective rights or obligations of the Contractor partners and of the legal representative of any deceased Contractor partners interest.

4.54. LABOUR

4.54.1 Wages to Labour – The Contractor shall be responsible to ensure compliance with the provisions of the Minimum Wages Act, 1948 (hereinafter referred to as the “said Act”) and the Rules made there-under in respect of any employees directly or through petty contractors or sub-contractors employed by him on road construction or in building operations or in stone breaking or stone crushing for the purpose of carrying out this contract. If in compliance with the terms of the contract, the contractor supplied any labour to be used wholly or partly under the direct orders and control of the RailTel whether in connection with any work being executed by the contractor or otherwise for the purpose of the RailTel such labour shall, for the purpose of this clause, still be deemed to be persons employed by the Contractor. If any moneys shall as a result of any claim or any claim or application made under the said Act be directed to be paid by the RailTel's, such moneys shall be deemed to be moneys payable to the RailTel by the Contractor and on failure by the Contractor to repay any moneys paid by it as aforesaid within seven days after the same shall have been demanded, the RailTel's shall be entitled to recover the same from any moneys due or accruing to the contractor under this or any other Contractor with the RailTel's.

4.54.2 Apprentices Act – The Contractor shall be responsible to ensure compliance with the provisions of the Apprentices Act 1961 and the Rules and Orders issued there- under from time to time in respect of apprentices directly through

petty contractors or sub-contractors employed by him for purpose of carrying out the contract. If the Contractor directly or through petty contractor or sub-contractors fails to do so, his failure will be a breach of the contract and the RailTel may, in its discretion, rescind the contract. The contractor shall also be liable for any pecuniary liability arising on account of any violation of the provisions of the Act.

4.55. Provisions of Payments of Wages Act

The Contractor shall comply with the provisions of the Payment of Wages Act, 1936 and the rules made there under in respect of all employees directly or through petty contractors or sub-contractors employed by him in the works. If in compliance with the terms of the contract, the contractor directly or through petty contractors or sub-contractors shall supply any labour to be used wholly or partly under the direct orders and control of the Engineer whether in connection with the works to be executed hereunder or otherwise for the purpose of the Engineer such labour shall nevertheless be deemed to comprise persons employed by the contractor, and any moneys which may be ordered to be paid by the Engineer shall be deemed to be moneys payable by the Engineer on moneys due to the contractor in terms of the contract. The RailTel shall be entitled to deduct from any moneys due to the contractor (Whether under this contract or any other contract all moneys paid or payable by the RailTel by way of compensation of aforesaid or for costs of expenses in connection with any claim thereto and the decision of the Engineer upon any question arising out of the effect or force of this clause shall be final and binding upon the contractor.

- 4.55.1 Provision of Contract Labour (Regulation and Abolition) Act 1970 (1) The Contractor shall comply with the provision of the Contract Labour (Regulation and Abolition) Act 1970 and the Contract Labour (Regulation and Abolition) Act, Central Rules 1971 as modified from time to time, whenever applicable and shall also indemnify the RailTel from and against any claims under the aforesaid Act and the Rules
- (2) The Contractor shall obtain a valid license under the aforesaid Act as modified from time to time before the commencement of the work and continue to have a valid license until the completion of the work. Any failure to fulfill this shall attract the penal provision of the Contract arising out of the resultant non-execution of the work.
 - (3) The Contractor shall pay to the labour employed by him directly or through sub-contractors the wages as per provisions of the aforesaid Act and the Rules wherever applicable. The Contractor shall notwithstanding the provisions of the contract to the contrary, because to be paid the wages to labour indirectly engaged on the work including any engaged by his sub-contractors in connection with the said work, as if the labour had been immediately employed by him.
 - (4) In respect of all labour directly or indirectly employed in the work for performance of the contractor's part of the contract the contractor shall comply with or cause to be complied with the provisions of the aforesaid Act and the Rules wherever applicable.

- (5) In every case in which, by virtue of the provisions of the aforesaid Act or the Rules, the RailTel is obliged to pay any amount of wages to a workmen employed by the contractor or his sub-contractor in execution of the work or to incur any expenditure in providing welfare and health amenities required to be provided under the aforesaid Act and the Rules or to incur any expenditure in providing welfare and health amenities required to be provided under the aforesaid Act the Rules or to incur any expenditure on account of the contingent liability of the RailTel due to contractor's failure to fulfill his statutory obligations under the aforesaid Act or the Rules the RailTel will recover from the contractor, the amount of wages so paid or the amount of expenditure so incurred, and without prejudice to the rights of the RailTel under section 20, sub-section (2) and section 2 sub - section (4) of the aforesaid Act, the RailTel shall be at liberty to recover such amount or part thereof by deducting it from the security deposit and/or from any sum due by the RailTel to the contractor whether under the contract or otherwise. The RailTel shall not be bound to contest any claim made against it under sub- section (1) of section 20 and sub-section (4) of section 21 of the aforesaid Act except on the written request of the contractor and upon his giving to the RailTel full security for all costs for which the RailTel might become liable in contesting such claim. The decision of the RailTel regarding the amount actually recoverable from the contractor as stated above, shall be final and binding on the contractor.

4.56. Reporting of Accidents to Labour

The Contractor shall be responsible for the safety of all employees directly or through petty contractors or sub-contractors employed by him on the works and shall report serious accidents to any of them however and wherever occurring on the works to the Engineer or the Engineer's Representative and shall make every arrangement to render all possible assistance.

4.57. Provisions of Workmen's Compensation Act

In every case in which by virtue of the provision of Section 12 sub-section (1) of the Workmen's Compensation Act, 1923, RailTel is obliged to pay compensation to a workman directly or through the petty Contractor employed by the Contractor or sub- contractor in executing the work, RailTel will recover from the contractor the amount of the compensation so paid, and, without prejudice to the right of RailTel under Section 12 sub-section (2) of the said Act. RailTel shall be at liberty to recover such amount or any part thereof by deducting it from the security deposit or from any sum due by RailTel to the Contractor whether under these conditions or otherwise, RailTel shall not be bound to contest any claim made against it under Section 12, sub-section (1) of the said Act except on the written request of the Contractor and upon his giving to RailTel full security for all costs for which RailTel might become liable in consequence of contesting such claim.

4.57.1 Provision of Mines Act – Deleted

4.58. RailTel not to provide quarters for Contractor

No quarters shall be provided by the RailTel for the accommodation of the contractor or any of his staff employed on the work.

4.59. Labour camps

- (1) The Contractor shall at his own expense make adequate arrangements for the housing, supply of drinking water and provision of latrines and urinals for his staff and workman directly or through the petty contractors or sub-contractors and for temporary crèche (Bal-Mandir) where 50 or more women are employed at a time. Suitable sites on Railway/RailTel land, if available, may be allotted to the Contractor for the erection of labour camps either free of charge or on such terms and conditions that may be prescribed by the RailTel. All camp sites shall be maintained in clean and sanitary conditions by the Contractor at his own cost.
- (2) **Compliance to Rules for Employment of Labour**
The Contractor(s) shall conform to all laws, bye-laws, rules and regulations for the time being in force pertaining to the employment of local or imported labour and shall take all necessary precautions to ensure and preserve the health and safety of all staff employed directly or through petty Contractors or sub -contractors on the works.
- (3) **Preservation of Peace** – The Contractor shall take requisite precautions and use his best endeavors to prevent any riotous or unlawful behavior by or amongst his workmen and others employed directly or through petty contractor or sub- contractors on the works and preserve the health and safety of all staff employed directly or through petty Contractors or sub-contractors on the works.
- (4) **Sanitary Arrangement** – The contractor shall obey all sanitary rules and carry out all sanitary measures that may time to time be prescribed by the RailTel Medical Authority and permit inspection of all sanitary arrangements at all times by the Engineer, the Engineer's Representative or the Medical Staff of the RailTel. Should the Contractor fail to make adequate sanitary arrangements, these will be provided by the RailTel and the cost therefore recovered from the contractor.
- (5) **Outbreak of Infectious Disease** – The Contractor shall remove from his camp such labour and their families as refuse protective inoculation and vaccination when called upon to do so by the Engineer or the Engineer's Representative on the advice of the Railway/RailTel Medical Authority. Should Cholera, Plague or other infectious disease break out, the Contractor shall burn the huts, beddings, clothes and other belongings of or used by the infected parties and promptly erect new huts on healthy sites as required by the engineer, failing which within the time specified in the Engineer's requisition, the work may be done by the RailTel and the cost therefore recovered from the Contractor.
- (6) Treatment of Contractor's staff in Railway Hospitals – Deleted
- (7) **Medical facilities at site** – The contractor shall provide medical facilities at the site as may be prescribed by the engineer on the advice of the medical

authority in relation to the strength of the contractor's resident staff, and workmen.

- (8) **Use of Intoxicants** – The sale of ardent spirits or other intoxicating beverages upon the work or in any of the buildings, encampments or tenements owned, occupied by or within the control of the Contractor or any of his employees shall be forbidden and the Contractor shall exercise his influence and authority to the utmost extent to secure strict compliance with this condition.
- (9) **Non-employment of Female Labour** – The contractor shall see that the employment of female labour in cantonment areas, particularly in the neighborhood of soldier's barracks, should be avoided as far as possible.
- (10) Restrictions on the employment of retired Engineers of Railway/Govt. services within two years of their Retirement– The contractor shall not, if he is a retired government engineer of Gazetted rank, who has not completed two years from the date of retirement, in connection with his contract in any manner whatsoever without obtaining prior permission of the President and if the contractor is found to have contravened this provision, it will constitute a breach of contract Administration will be entitled to terminate the contract at the risk and cost of the contractor and forfeit his security deposit.

4.60. Non-Employment of Labourers below the age of 15

- (1) The Contractor shall not employ children below the age of 15 as labourers directly or through petty contractors or sub-contractors for the execution of work. To be checked.
- (2) **Medical Certificate of Fitness for Labour** – It is agreed that the contractor shall not employ a person above 15 and below 19 years of age for the purpose of execution of work under this contract unless a medical certificate of fitness in the prescribed form granted to him by a certifying surgeon certifying that he is fit to work as an adult is obtained and kept in the custody of the contractor or a person nominated by him in this behalf and the person carries with him, while at work, a token giving a reference to such certificate. It is further agreed that the responsibility for having the adolescent examined medically at the time of appointment or periodically till he attains the age of 19 years shall devolve entirely on the contractor and all the expense to be incurred on this account shall be borne by him and no fee shall be charged from the adolescent or his parent for such medical examination.
- (3) **Period of Validity of Medical Fitness Certificate** - A certificate of fitness granted or renewed for the above said purposes shall be valid only for a period of one year at a time. The certifying surgeon shall revoke a certificate granted or renewed if in his opinion the holder of it is, no longer fit for work in the capacity stated therein. Where a certifying surgeon refuses to grant or renew a certificate or revoke a certificate, he shall, if so required by the person concerned, state his reasons in writing for doing so.
- (4) **Medical Re-examination of Labourer** - Where any official appointed in this behalf by the Ministry of Labour is of the opinion that any person employed in connection with the execution of any work under this contract in the age group

15- 19 years is without a certificate of fitness or is having a certificate of fitness but no longer fit to work in the capacity stated in the certificate, he may serve on the Contractor, or on the person nominated by him in this regard, a notice requiring that such person shall be examined by a certifying surgeon and such person shall not, if the concerned official so directs, be employed or permitted to do any work under this contract unless he has been medically examined and certified that he has been granted a certificate of illness or a fresh certificate or a fresh certificate of illness, as the case may be.

4.61. Determination of Contract

4.61.1 **Right of RailTel to determine the contract:** The RailTel shall be entitled to determine and terminate the contract at any time, should in the RailTel's opinion, the cessation of work becomes necessary owing to paucity of funds or from any other cause whatever, in which case the value of approved materials at site and of work done to date by the Contractor will be paid for in full at the rate specified in the contract. Notice in writing from the RailTel of such determination and the reasons therefore shall be conclusive evidence thereof.

4.61.2 **Payment on determination of contract:** Should the contract be determined under Para 4.61.1 and the Contractor claims payment for expenditure incurred by him in the expectation of completing the whole of the work, the RailTel shall admit and consider such claims as are deemed reasonable and are supported by vouchers to the satisfactions of the Engineer. The RailTel's decision on the necessity and propriety of such expenditure shall be final and conclusive.

4.61.3 The contractor shall have no claim to any payment of compensation or otherwise, howsoever on account of any profit or advantage which he might have derived from the execution of the work in full but which he did not derive in consequence of determination of contract.

4.62. TERMINATION OF CONTRACT OWING TO DEFAULT OF CONTRACTOR:

4.62.1(A) If the Contractor :

- (i) becomes bankrupt or insolvent, or
- (ii) make an arrangement with or assignment in favour of his creditors, or
- (iii) being a Company or Corporation, go into liquidation (other than voluntary), liquidation for the purpose of amalgamation or reconstruction, or
- (iv) have an execution levied on his goods or property on the works, or assign the contract or any part thereof otherwise than as provided in Para 5.21 of SCC, or
- (v) have an execution levied on his goods or property on the works, or assign the contract or any part thereof otherwise than as provided in Para 5.21 of SCC, or
- (vi) persistently disregard the instructions of the RailTel's Engineer with regard to work quality or progress during execution of work or contravene any provision of the contract, or

- (viii) fail to adhere to the agreed programme of work by a margin of 10% of the Stipulated period, or fail to remove materials from the site or to pull down and replace the work after receiving from the Engineer's notice to the effect that the said materials or works have been condemned or rejected, or
 - (ix) fail to take steps to employ competent or additional staff and labour as required under Para 4.26 of tender document.
 - (x) fail to afford the Engineer or Engineer's representative proper facilities for inspecting the works or any part thereof as required under Para 4.28 of tender document, or
 - (xi) Promise offer or give any bribe, commission, gift or advantage either himself or through his partner, agent or servant to any officer or employee of RailTel or any person on his or on their behalf in relation to the execution of this or any other contract with the RailTel,
 - (xii) At any time after the tender relating to the contract has been signed and submitted by the contractor, being a partnership firm admit as one of its partners or employ under it or being an incorporated company elect or nominate or allow to act as one of its directors or employ under it in any capacity whatsoever any retired engineer of the gazetted rank or any other retired gazetted officer working before his retirement, whether in the executive or administrative capacity, or whether holding any pensionable post or not, in the Engineering Department of the Railways for the time being owned and administered by the President of India before the expiry of two years from the date of retirement from the said service of such Engineer or Officer unless such Engineer or Officer has obtained permission from the President of India or any officer duly authorized by him in this behalf to become a partner or a director or to take employment under the contract as the case may be, or
- (B) Fail to give at time of submitting the said tender:
- (a) The correct information as to the date of retirement of such retired engineer or retired officer from the said service, or as to whether any such retired engineer or retired officer was under the employment of the contractor at the time of submitting the said tender, or
 - (b) the correct information as to such engineers or officers obtaining permission to take employment under the contractor, or
 - (c) being a partnership firm the correct information as to, whether any of its partners was such a retired engineer or retired officer, or
 - (d) being an incorporated company, the correct information as to, whether any of its directors was such a retired engineer or retired officer, or
 - (e) being such a retired engineer or retired officer suppress and not disclose at the time of submitting the said tender the fact of his being such a retired engineer or a retired officer or make at the time of submitting the said tender a wrong statement in relation to his obtaining permission to take the contract or if the contractor be a partnership firm or an incorporated company to be a partner or director of such firm or company as the case may be or to seek employment under the contractor. Then and in any of these said clauses, the Engineer on behalf of the RailTel may serve the Contractor with a notice in writing to that effect and if the Contractor does not, within 7 days after the delivery to him of such notice, proceed to make good his default in so far as the same is capable of being made good and carry on the work or comply with such directions as aforesaid to the entire satisfaction of the Engineer, the

RailTel shall be entitled after giving 48 hours notice in writing under the hand of the Engineer to rescind the contract as a whole or in part or parts (as may be specified in such notice) and adopt either or both the following courses: A final termination notice will be issued by RailTel after expiry of 48 hrs notice.

4.62.2 RIGHT OF RAILTEL AFTER TERMINATION OF CONTRACT OWING TO DEFAULT OF CONTRACTOR:

In the event of any or several of the courses, referred in Para 4.62.1 of tender document above, being adopted:

- (a) The Contractor shall have no claim to compensation for any loss sustained by him by reason of his having purchased or procured any materials or entered into any commitments or made any advances on account of or with a view to the execution of the works or the performance of the contract and Contractor shall not be entitled to recover or be paid any sum for any works thereto not actually performed under the contract, unless or until the Engineer shall have certified the performance of such work and the value payable in respect thereof and the Contractor shall only be entitled to be paid the value so certified.
- (b) The Engineer or Engineer's Representative shall be entitled to take possession of any materials, tools, implements, machinery or buildings on the works or on the property on which these are being or ought to have been executed, and to retain the (employ the same) in the further execution of the works or any part thereof until the completion of the works without the Contractor being entitled to any compensation for the use and employment thereof or for wear and tear or destruction thereof.
- (c) The Engineer shall, as soon as may be practicable after removal of the Contractor fix and determine expert or by or after reference to the parties or after such investigation or enquiries as he may consider fit to make or institute and shall certify what amount (if any) has at the time of termination of the contract been reasonably earned by or would reasonably accrue to the Contractor in respect of the work then actually done by him under the contract what was the value of any unused or partially used materials, any constructional plants and any temporary works upon the site. The legitimate amount due to the contractor after making necessary deductions and certified by the Engineer should be released expeditiously.

4.63. Matters finally determined by the RailTel: All disputes and differences of any kind whatsoever arising out of or in connection with the contract, whether during the progress of the work or after its completion and whether before or after the determination of the contract shall be referred by the contractor to the RailTel and the RailTel shall within 120 days receipt of the Contractor's representation make and notify decisions on all matters referred to by the contractor in writing provided that matters for which provision has been made in Para 4.8, 4.18, 4.22.5, 4.29, 4.43.2, 4.45(a), 4.55, 4.55.1(5), 4.57, 4.61.1, 4.61.2 and 4.62.1(A) of General Condition of Contract or in any clause of the Special Conditions of the Contract shall be deemed as 'excepted matters' and decisions of the RailTel's authority, thereon shall be final and binding on the

contractor provided further that 'excepted matters' shall stand specifically excluded from the purview of the arbitration clause and not be referred to arbitration.

4.64. SETTLEMENT OF DISPUTE AND ARBITRATION

- 4.64.1 Any dispute or difference whatsoever arising between the parties out of or relating to the construction, meaning, scope, operation or effect of this contract or the validity or the breach thereof shall be settled by a sole arbitrator in accordance with provisions contained in Arbitration and Conciliation Act, 1996 as amended and the award made in pursuance thereof shall be binding on the parties. The venue of such arbitration or proceedings thereof shall be New Delhi.
- 4.64.2 All arbitration proceedings shall be conducted in English. Resources against any Arbitral award so rendered may be entered into court having jurisdiction or application may be made to such court for the order of enforcement as the case may be.
- 4.64.3 The Arbitral Tribunal shall consist of the sole Arbitrator if the value of claim is upto Rs. 10 Lakhs. The arbitrator will be appointed by the Chairman and Managing Director of RailTel Corporation of India Ltd. If the value of claim or amount under dispute is more than Rs. 10 Lakhs, the matter shall be referred to the adjudication of arbitral council. Chairman and Managing Director/RailTel shall furnish a panel of three names to the contractor, out of which the contractor will recommend one name to be his nominee and then Chairman and Managing Director/RailTel shall appoint out of the panel, one name as RailTel's nominee and these two arbitrators with mutual consent appoint a third arbitrator who shall act as deciding. The award of the sole arbitrator or the Arbitral council, as the case may be, shall be final and binding on both the parties, i.e. Contractor and RailTel Corporation of India Ltd.
- 4.64.4 Each of the parties agree that notwithstanding that the matter may be referred to Arbitrator as provided therein, the parties shall nevertheless pending the resolution of the controversy or disagreement continue to fulfill their obligation under this Agreement so far as they are reasonably able to do so.

RAILTEL
A Government of India
Undertaking

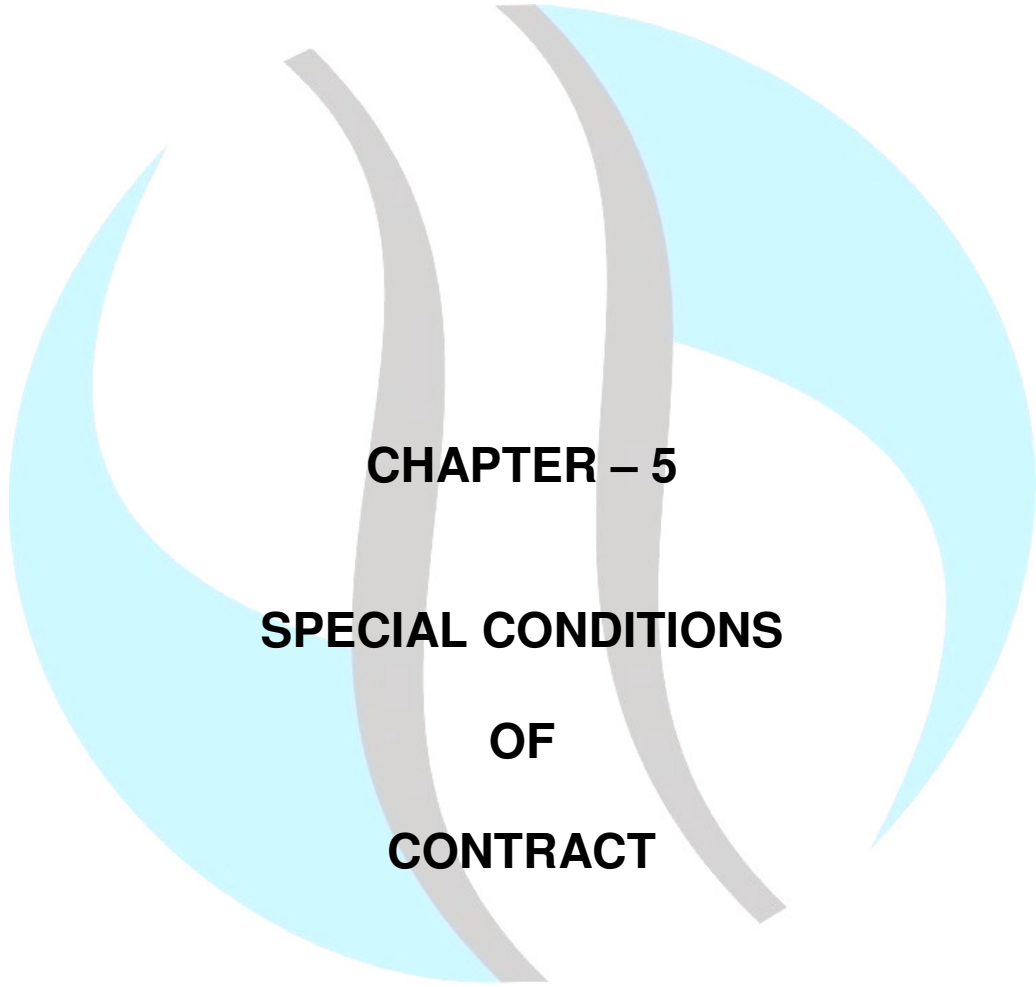

CHAPTER – 5

SPECIAL CONDITIONS

OF

CONTRACT

रेलटेल
RAILTEL

A Government of India
Undertaking

CHAPTER - 5**Special Conditions of Contract
I N D E X**

Para	Subject
5.1.	Tender Document
5.2.	Agreement
5.3.	Security Deposit & Performance Bank Guarantee
5.4.	Contractor's Office & Stores depot
5.5	Use of Railway land
5.6.	Program of work.
5.7	Competent Supervisors
5.8	Stores to be supplied by RailTel
5.9	Not used
5.10	Test & Measuring Instruments, Special tools & Installation material
5.11	Stores to be supplied by contractor
5.12	Supply of Technical Literatures, Documentation Drawings & Completion Plan etc.
5.13	Spares
5.14	Long term availability of spares & System support
5.15	Quality assurance
5.16	Not used
5.17	Inspection of materials
5.18	Inspection of works
5.19	Quantum of work and variation in Quantities
5.20	Not used
5.21	Subletting and assignment
5.22	Execution of works

- 5.23 Not used
- 5.24. Maintenance of works
- 5.25. Clearance of site
- 5.26. Provisional Acceptance
- 5.27. Maintenance of work till issue of Last PAC
- 5.28. Final Acceptance
- 5.29. Warranty
- 5.30. Training
- 5.31. Infringement of Patents
- 5.32. License as per Govt. of India Contract Labour Act
- 5.33. Defaults and Delays
- 5.34. Loss Sustained Due to Default and Delay
- 5.35. Penalty for Delay in Completion
- 5.36. Adherence of time schedule
- 5.37. Contractors liabilities for Costs and Damages
- 5.38. Prices
- 5.39. Measurement of works
- 5.40. Terms of Payments
- 5.41. Final Payment
- 5.42. Final Settlement
- 5.43. Certificate for CENVAT BENEFITS on bills
- 5.44. Deductions from On Account Payment Bills
- 5.45. Taxes
- 5.46. Mobilization Advance
- 5.47. Insurance
- 5.48. Force Majeure Clause
- 5.49. Settlement of dispute and Arbitration

CHAPTER - 5
SPECIAL CONDITIONS OF CONTRACT

5.1. TENDER DOCUMENTS

- 5.1.1 The goods and services required, bidding procedure and contract terms are prescribed in the tender documents. The set of tender documents issued for the purpose of bidding includes following together with any addendum and corrigendum thereto.
- 5.1.2 If the Tender submitted by a Tenderer is accepted and the contract awarded to the Tenderer the various works coming under the purview of the contract shall be governed by tender documents mentioned above.
- 5.1.3 Any special conditions stated by the Tenderer in the covering letter submitted along with the tender shall be deemed to be a part of the Contract to such extent only as have been explicitly accepted by the RailTel .

5.2. AGREEMENT

- 5.2.1 The successful Tenderer shall within 15 days after having been called upon by notice to do so be bound to execute an agreement based on accepted rates and conditions, in such form as the RailTel may prescribe, and lodge the same with the RailTel together with the conditions of contract, specifications and Schedule Of Requirements referred to therein duly completed. The form for agreement is included in , Chapter - 6 (Form No.3).
- 5.2.2 In the event of any tenderer whose tender is accepted, refused to execute the Contract documents as herein before provided RailTel may determine that such tenderer has abandoned the contract and thereupon his tender and the acceptance thereof shall be treated and RailTel shall be entitled to forfeit the full amount of the earnest money and to recover the liquidated damage for such default.

5.3 SECURITY DEPOSIT & PERFORMANCE BANK GUARANTEE

5.3.1 Security deposit:-

The amount of EMD of the successful tenderer shall be adjusted against SD (5% of the contract value). The balance amount will be recovered from the Contractor's "on account" bills (10% of bill amount).

- i. Unless otherwise specified in the special conditions, if any, the rates for Deposit /rate of recovery/ mode of recovery shall be as under:
- (a) Security Deposit for work should be 5% of the contract value .

- (b) The rate of recovery should be at the rate of 10% of the bill amount till the full security deposit is recovered.
- (c) Security Deposits will be recovered only from the running bills of the contractor and no other mode of collecting SD such as SD in the form of instruments like BG, FD etc shall be accepted towards Security Deposit.
- i. Security Deposit shall be returned to the contractor after the complete physical completion of the work in all the Blocks/Schedules as certified by the competent authority & submission of PBG of 10% of annual maintenance cost in case of AMC. The competent authority shall normally be the authority who is competent to sign the contract.
- ii. No interest will be payable upon the Earnest Money and Security Deposit or amounts payable to the contractor under the Contract.

5.3.2 Performance Bank Guarantee:-

The successful bidder shall give a Performance Bank Guarantee in the form of an irrevocable bank Guarantee amounting to 5% of contract value for schedule as per form No.-4

- i) The successful bidder shall have to submit a Performance Bank Guarantee (PBG) within 15 (Fifteen) days from the date of issue of Letter Of Acceptance (LOA). Extension of time for submission of PBG beyond 15 (Fifteen) days and up to 30 days from the date of issue of LOA may be given by the authority who is competent to sign the contract agreement. However, a penal interest of 15% per annum shall be charged for the delay beyond 30 (thirty) days, i.e. from 31st day after the date of issue of LOA. In case the contractor fails to submit the requisite PBG even after 60 days from the date of issue of LOA, the contract shall be terminated duly forfeiting EMD and other dues, if any, payable against that contract. The failed contractor shall be debarred from participating in re-tender for that work.
- ii) The Performance Bank Guarantee shall be submitted by the successful bidder after the Letter of Acceptance (LOA) has been issued, but before signing of the contract agreement. This P.B.G shall be initially valid up to stipulated date of completion plus 60 days beyond that. In case, the time for completion of work gets extended, the contractor shall get the validity of P.G. extended to cover such time for completion of work plus 60 days.
- iii) The value of P.B.G. to be submitted by the contractor will not change for variation up to 25% (either increase or decrease). In case during the course of execution, value of the contract increases by more than 25% of the original contract value, an additional Performance Bank Guarantee amounting to 5% (five percent) for the excess value over the original contract value shall be deposited by the contractor.
- iv). The Performance bank Guarantee (PBG) shall be released after a period of 12 months & issue of Final Acceptance Certificate commencing immediately after completion of the work, which will be enforceable by

RailTel.

5.3.3 **In case of Annual Maintenance contract**, the successful bidder shall also give a performance bank guarantee in the form of an irrevocable bank guarantee amounting to 10% of contract value as per form no.-4 on issue of Last PAC of the Block.

i) PBG should be valid for 60 days beyond the mandate maintenance period of 1 year currency period. This PBG is to be submitted on issue of Last PAC to be eligible for being paid AMC charges.

ii) PBG for maintenance shall be released after “satisfactory completion of maintenance period of one year”

5.3.4 Whenever the contract is rescinded, the Security Deposit shall be forfeited and the Performance Bank Guarantee shall be encashed. The balance work shall be got done independently without risk and cost of the failed contractor. The failed contractor shall be debarred from participating in the tender for executing the balance work. If the failed contractor is a JV or a Partnership firm, then every member/partner of such a firm shall be debarred from participating in the tender for the balance work in his/her individual capacity or as a partner of any other JV/partnership firm.

5.4. **CONTRACTOR'S OFFICE & STORES DEPOT**

The Contractor shall within 10(ten) days of issue of letter of acceptance of tender establish an office and store depot at a convenient place for receiving and storing equipments and materials and progressing field work expeditiously in consultation and with the approval of the purchaser's Engineer. He shall intimate the address thereof to which all correspondence should be sent. Any communication sent to the contractor by post at his said address shall be deemed to have reached the contractor duly and in time. Important documents shall be sent by Registered post.

5.5. **USE OF RAILWAY LAND :Deleted**

5.6. **PROGRAMME OF WORK**

5.6.1 Refer Para 4.19,4.20,4.21,4.22,4.23 and 4.26 of chapter-4.

5.6.2. The contractor will program his work in such a manner so as not to interfere in the working and movement of traffic

5.7. **COMPETENT SUPERVISORS**

Refer Para 4.26 of chapter-4 .

5.8. **STORES TO BE SUPPLIED BY RAILTEL.**

Refer Para 1.17 of chapter-1

5.9. **Not used**

5.10. TEST & MEASURING INSTRUMENTS AND SPECIAL TOOLS ETC.

5.10.1 Special tools & instruments required for installation and commissioning of the work as detailed in preamble shall be arranged by contractor at his own cost.

5.10.2 All tests and measuring instruments and other arrangements required for carrying out all the acceptance tests etc shall be provided by the contractor at his own cost.

5.11. STORES TO BE SUPPLIED BY CONTRACTOR

Refer Para 1.18 .

5.12 SUPPLY OF TECHNICAL LITERATURES, DOCUMENTATION DRAWINGS, INSTRUCTION BOOK & COMPLETION PLANS ETC.

The contractor shall supply complete documentation as per para 7.11 of chapter-7 of tender document.

5.13 SPARES

Deleted

5.14 LONG TERM AVAILABILITY OF SPARES AND SYSTEM SUPPORT

Deleted

5.15. QUALITY ASSURANCE

Quality Control through Acceptance Testing will be done by RailTel as per guidelines issued by BBNL from time to time .BBNL will carry out sample checks. Shortcomings /deficiencies noted has to be attended with in 10(ten) days and intimation has to be given.

5.16. Not used

5.17 INSPECTION OF MATERIALS

5.17.1 All equipments materials fittings and components supplied by the contractor are required to be inspected as per the codes and specifications by the purchaser or his representative before accepting the delivery.

5.17.2 The materials which are procured/fabricated should comply TEC Specifications.

5.17.3 All materials shall be procured from the manufacturers of repute/their authorized dealers. Such materials are to be accepted by the Engineer. The contractor may be required to produce test certificate from the manufacturer wherever called for by the Engineer.

5.17.4 The inspection charges, if any, payable to the purchaser's representative for carrying out the inspection shall be borne by the purchaser.

5.17.5 The cost of equipment and materials, all tests and / or analysis performed for inspection shall be borne by the contractor.

5.18. INSPECTION OF WORKS

The contractor shall sign all the measurement recorded in the measurement book. The contractor, of measurement recorded in the MB, will consider this as an acceptance. In case contractor fails to attend at the measurements or fails to countersign or to record the difference within a week, then in any such events the measurements taken by Engineer ex party shall be final and binding on the contractor.

The contractor shall facilitate resources for reopening of trench for test check. No additional payment shall be made to the contractor for excavation of such test checks.

5.19. QUANTUM OF WORK AND VARIATION IN QUANTITIES

5.19.1. **Modification to contract to be in writing :-** Please refer clause 4.41 of chapter 4.

5.19.2.1 **Powers of modification to contract :**
Please refer clause 4.42 of chapter 4.

5.20. Not used

5.21. SUBLETTING AND ASSIGNMENT

5.21.1 The contractor may sublet a part of the work under this contract and enter into contract with suppliers for supply of materials. The credentials of subcontractors shall be subjected to scrutiny and approval of RailTel.

5.21.2 The contractor shall arrange for effective supervision of sub contractor's work and remain solely responsible for materials supplied and for works carried out on his behalf by the sub contractor.

5.22. EXECUTION OF WORK

All the works shall be executed in strict conformity to the provisions of the contract document and with such explanatory detailed drawings, specifications and instructions as may be approved from time to time based on detailed design and engineering carried out by contractor in line with requirements as per contract document. The contractor shall be responsible for ensuring that the work throughout are executed in the most substantial, proper and workman like manner with the quality of material and workmanship in strict accordance with the specifications and as per sound industrial practices and to the entire satisfaction of the RailTel.

5.23. Not used**5.24. MAINTENANCE OF WORKS**

The contractor shall at all times during the progress and continuance of the works and also for the period of maintenance specified in the tender form and after the date of passing of the certificate of completion by the RailTel 's representative or any other earlier date subsequent to the completion of the works that may be fixed by RailTel 's representative be responsible for and effectively maintain and uphold in good, substantial, sound and perfect condition all and every part of the works and shall make good from time to time and at all times, as often as the RailTel 's representative shall require, any damage or defect that may, during the above period, arise in or be discovered or be in any way connected with the works provided that such damage or defect is not directly caused by errors in the contract documents, act of providence or insurrection or civil riot and the contractor shall be liable for and shall pay and make good to the RailTel or other persons legally entitled thereto whenever required by the RailTel 's representative so to do, all losses, damages, costs and expenses they or any of them may incur or be put or be liable to, by reason or in consequence of the operations of the contractor or his failure in any respect.

5.25. CLEARANCE OF SITE

At the end of the work at each location the Contractor shall as a part of his Contractual obligation leave the area completely neat and clean.

5.26. PROVISIONAL ACCEPTANCE CERTIFICATE (PAC)

5.26.1 Immediately after the completion of the work of the whole block , the contractor shall certify and advise the purchaser in writing that the installation is (i) complete (ii) ready for satisfactory commercial service and (iii) ready to be handed over.

5.26.2 Purchaser's Engineer shall issue a Provisional Acceptance Certificate (PAC) for successful commissioning, of covering all materials and services included in the Schedule of works after the final acceptance test as per the approved test procedures have been completed and the performance has been found to meet the specifications. PAC shall not be held up for want of minor deficiency which shall be attended by the contractor within reasonable time to the satisfaction of Engineer. Part PAC will be issued for the Block, where contractor has completed all the work except the work pending due to RoW /FPOI and /or any other reasons beyond the scope of contractor on production of an undertaking from the contractor stating that contractor will complete the left over work as and when these permissions are available .The competent authority in RailTel will decide on sections involved and the extent of work

completed. RailTel's decision in this respect shall be final. The Provisional Acceptance Certificate shall be signed by both the parties.

After that , Last PAC will be issued for successful commissioning, covering all materials and services included in the Schedule of works after the final acceptance test as per the approved test procedures have been completed and the performance has been found to meet the specifications

5.27 MAINTENANCE OF WORK TILL ISSUE OF LAST PAC

The contractor shall be responsible for proper maintenance of the work at his own cost until Last PAC of the Block is issued and work of whole Block is completed .During this period, the tenderer shall have to attend any fiber cut etc. which takes place.

5.28. FINAL ACCEPTANCE CERTIFICATE (FAC)

5.28.1 The final acceptance of the works shall take effect from the date of expiry of the period of warranty as defined in Para 5.29 i.e on expiry of the warranty period from the date of issue of last Provisional Acceptance Certificate or brought into commercial operation, provided in any case that the contractor has complied fully with his obligations in respect of each item under the contract.

5.28.2 Notwithstanding the issue of Final Acceptance Certificate the contractor and the purchaser (subject to Sub Clause as above) shall remain liable for fulfillment of any obligation incurred under the provision of the contract prior to the issue of Final Acceptance Certificate which remains unperformed at the time such certificate is issued and for determining the nature and extent of such obligation the contract shall be deemed to remain in force between the parties hereto.

5.29. WARRANTY

5.29.1 All equipment /material supplied by the Contractor shall be guaranteed against the defects for a period of 12 months from the date of issue of Last Provisional Acceptance Certificate of the works. The contractor shall provide comprehensive warranty maintenance for all the items supplied by him against this tender.

5.29.2 Contractor will ensure availability of adequate spares for providing replacement of faulty material , items during the warranty.

5.29.3 If any equipment/material supplied by the contractor becomes defective during the warranty ,the same shall be replaced by the contractor and total cost of such replacement shall be born by the contractor. The replaced material will also be guaranteed for the remaining period of original warranty.

5.29.4 DELETED

5.29.5 Regarding Restoration of any damage/defect in already laid fibers, where the reasons of damage are other than workmanship of the contractor:

- Before issue of PAC: Material will be provided by RailTel for restoration but contractor will attend the cut/damage/defect at his own cost.
- During warranty period: Materials as well as payment as per LOA rate will be given for restoration work.

5.30. Training

5.30.1 Deleted

5.30.2 The contractor shall at every stage of installation; testing and commissioning provide all facilities for adequate training of RailTel personnel who may be deputed to work on the project.

5.31. INFRINGEMENT OF PATENTS:

- (a) The Contractor is forbidden to use any patents or registered drawings, processes or patterns in fulfilling his contract without prior consent in writing of the owner of such patents, drawings, patterns or trademarks except where these are specified by the Purchaser himself. Royalties where payable for the use of such patented processes, registered drawings or patterns shall be borne exclusively by the Contractor. The Contractor shall advise the Purchaser of any proprietary rights that may exist on such processes, drawings or patterns which he may use of his own accord.
- (b) In the case of patents taken out by the Contractor of the drawings or patterns registered by him or of those patents, drawings or patterns for which he holds a license, the signing of the contract automatically gives the Purchaser the right to repair by himself the purchased articles covered by the patent or by any person or body chosen by him and to obtain from any sources he desires the component parts required by him for carrying out the repair work. In the event of infringement of any patent rights due to above action of the Purchaser he shall be entitled to claim damages from the Contractor on the grounds of any loss of any nature which he may suffer e.g. in the case of attachment because of counterfeiting.

5.32. LICENSE AS PER GOVT. OF INDIA CONTRACT LABOUR ACT

The Contractors are required to produce license as enjoined in the Government of India Contract Labour (Regulation and Abolition) Act (1978) with latest amendments, if any. They shall not be allowed to undertake or execute any work through contract Labour except

under and in accordance with a license issued under the said Act in that behalf by the authorized licensing Officer.

5.33. DEFAULTS AND DELAYS

The Contractor shall execute the work with due diligence and expedition, keeping to the approved time schedule. Should he refuse or neglect to comply with any reasonable orders given to him in writing by the Purchaser's Engineers in connection with the work or contravene the provision of the Contract or the progress of work lags persistently behind the time schedule due to his neglect, the Purchaser shall be at liberty to give seven days notice in writing to the Contractor requiring him to make good the neglect or contravention complained of and should the Contractor fail to comply with the requisitions made in the notice within seven days from the receipt thereof, it shall be lawful for the purchaser to take the work wholly or in part out of the Contractor's hands without any further reference and get the work or any part thereof, as the case may be, completed by other agencies at the expense of the Contractor without prejudice to any other right or remedy of the Purchaser.

5.34. LOSS SUSTAINED DUE TO DEFAULTS AND DELAYS

In the event of any loss to the purchaser on account of execution and/or completion of the work or any part thereof by agencies other than the contractor, in terms of Para 5.33 of the tender document, the contractor shall be liable to reimburse the loss to purchaser without prejudice to the other rights and remedies of the purchaser and the reimbursement in full or in part, as the case may be, shall be met at the option of the purchaser from out of all or any of the following sources via :

- (a) I) Any amount due and payable to the contractor by the purchaser on any account whatsoever;
- ii) The Contractor's security deposit in the hands of the purchaser as far as available, and;
- iii) Any other assets whatsoever of the contractor;
- (b) In the event of re-imburement from out of sources (I) and/or (ii) above mentioned, the purchaser shall have the right of appropriation sue motto.

5.35. PENALTY FOR DELAY IN COMPLETION

- 5.35.1 The time for the execution of the work or part of the works specified in the contract documents shall be deemed to be the essence of the contract and the works must be completed not later than the date(s) as specified in the contract. If the contractor fails to complete the works within the time as specified in the contract for the reasons other than the

reasons specified in Para 5.48 of tender document, Penalty for delay in execution of pending work/route @0.5% for each week of delay or part thereof for a period up to 10 weeks and thereafter at the rate of 0.7% for each week of delay or part thereof for another 10 weeks subject to a maximum of 12% will be applicable .

The competent Authority while granting extension of currency of the contract may also levy token penalty as deemed fit based on the merit of cases like delay in permission from Railways, changes in drawings, ROW from different agencies, changes in specifications and delay in partial way on account of contractors.

Provided further, that if the RailTel is not satisfied that the works can be completed by the Contractor and in the event of failure on the part of the contractor to complete the work in the time allowed as aforesaid, the RailTel shall be entitled without prejudice to any other right or remedy available in that behalf; to appropriate the contractor's security deposit and rescind the contract, whether or not actual damage is caused by such default.

5.35.2 Penalty for cutting/damaging the existing cables of RAILTEL and the existing underground facilities of third parties: -

- (a) During excavation of trench utmost care is to be taken by the contractor so that the existing underground cables are not damaged or cut. In-case any damage/cut is done to the existing cables, a penalty as per the schedule given below will be charged from the contractor or the amount will be deducted from his running bills:-

Size of existing UG/ OFC cut/ damaged	Amount of penalty per cut/ damage
Up to 100 pairs cable	Rs 500.00 (Five Hundred)
Above 100 pairs & up to 400 pairs	Rs 1000.00 (One thousand)
Above 400 pairs	Rs 2000.00 (Two thousand)
OFC of any size	Rs 50000.00 (Fifty thousand)

Besides the above penalty, the contractor shall carry out such repairs for restoration of the damaged cable free of charge. The cost of jointing kit shall also be borne by the contractor. If contractor fails to repair the damage, the cost of repair (including cost of labour + jointing kit) shall be recovered from the contractor.

- (b) Contractor shall either pay to third parties all expenditure incurred for restoring services which are damaged by Contractor

while carrying out the work or the same amount will be deducted from his bills. Such expenditure shall be intimated to Contractor either by Engineer-in-charge or concerned third parties in writing. The amount deducted by the Contractor from his bill shall be paid to concerned third parties by Engineer-in-charge.

- (c) Engineer-in-charge at his absolute discretion shall reserve the right to reject any bill submitted by the Contractor prior to making payment by him to third parties for the damages caused or to deduct same amount from his bill.
- (d) Penalty to damage stores/materials supplied by the RAILTEL while laying:

The contractor while taking delivery of materials supplied by the RAILTEL at the designated place shall thoroughly inspect all items before taking them over. In case of execution of the work, if any material is found damaged/working unsatisfactorily, then a penalty equivalent to the cost of material + 10% as penalty shall be recovered from the contractor's payments/securities.

- (e) However, contractor will not be penalized for any defect in workmanship of the materials, which are directly supplied by Railtel.

5.35.3. If M/s BBNL imposes any penalty on account of bad workmanship or delays, the same shall be charged to the contractor back to back.

5.36. ADHERENCE OF TIME SCHEDULE

5.36.1 Timely completion of the work is the essence of the contract. While delay in execution will attract penalty.

5.36.2 If any delay as aforesaid in Para 5.35 of tender document shall have arisen from any cause which the Purchaser may agree as being a reasonable ground for extension of time the purchaser's engineer or his representative may allow such additional time as he may in his absolute discretion consider to be reasonably justified by the circumstances of the case. Such extensions shall be granted, on request from contractor, with liquidated damages in the Form No.11.

5.37. CONTRACTOR'S LIABILITIES FOR COSTS AND DAMAGES

Please Refer Para 4.52 of the tender document.

5.38. PRICES

5.38.1 This tender consists of a percentage bidding system. The estimated cost of each and every item of the schedule of work and total estimated cost are indicated in the Schedule of work. The tenderer is expected to quote the single percentage, At Par/Below(-)/Above(+) the RailTel's total estimated cost for all schedules of work. The single percentage, At

par/below/above finalized for the entire work shall be firm and on all-inclusive basis (inclusive all incidental charges for transport, loading/unloading and handling of materials, commission for arranging dispatch by rail direct from manufacturer's factory and completing all necessary formalities in this respect, such as submission of forwarding notes, arranging placement of Wagon, collection of banker's charges for Bank guarantee, Indemnity Bonds inclusive of cost of Stamp etc., if any, levied by the RailTel.)

- 5.38.2 The prices shall include all taxes, duties, Royalty , GST and levies applicable on this Works Contract. Therefore, they should quote their rate taking into account the rate of GST on works contract as livable. It is clarified that required form applicable for this purpose will be supplied to the Contractor as applicable in the state where the Contract is being executed.
- 5.38.3 The rate quoted by the tenderer shall include cost of commissioning and testing and all costs of Administration of Contract, Insurance Premium, Banker's charges for guarantees, cost of storage, loading-unloading and handling of materials and for any road transport which the contractor may use for carriage of materials to his depot and the site of work. The prices shall include the cost of works and adjustments necessary to be done by the contractor during or after tests carried out by the purchaser.
- 5.38.4 The rate to be quoted by the Tenderers should take into account the credit availed on inputs under the CENVAT scheme. The tenderer should give a declaration that any set off in respect of duties on inputs as admissible under law is being totally and unconditionally passed on to the purchaser in the price quoted by him (see Para 5.43).
- 5.38.5 While the price quoted in the contract are inclusive of all taxes i.e. CGST, SGST, IGST, UTGST etc levied by any statutory authority, the purchaser shall make any deduction toward GST on works contract if statutorily required to do so. The deducted GST on works contract shall be remitted to the concerned tax authority and the purchaser shall in no way be responsible for any disputes between the tax authorities and the contractor in this regard.
- 5.38.6 All taxes, duties and levies (whether payable under reverse charge by the recipient or by the contractor) arising out of the transactions under the contract or between the contractor and his sub contractor/supplier for this work will be included in the rates quoted by the contractor in the relevant Schedule.
Any statutory revision/variation in taxes / duties shall be to the RailTel account and shall be admissible on production of valid documentary evidence. For this tenderer shall submit the taxes / duties structure considered by him while quoting the rates".
However, if the rates are reduced after the last stipulated date for receipt of tender, bidder has to pass on the benefits to RailTel/BBNL.

- 5.38.7 Arrangement for permits/license for materials will not be made by the RailTel or any assistance given. The Contractor will have to make his own arrangement.
- 5.38.8 On implementation of GST, for all taxable supplies made by the vendor, vendor will issue valid tax invoice in accordance with GST Act in order to enable BBNL to avail input tax credit.
For all the taxable supplies made by the vendor, the vendor shall furnish all the details of such taxable supplies in the relevant returns to be filed under GST Act.
If the vendor fails to comply with any of the above, the vendor shall pay to purchaser any expense, interest, penalty as applicable under the GST Act.
In case of incorrect reporting of the supply made by the vendor in the relevant return, leading to disallowance of input credit to purchaser, the vendor shall be liable to pay applicable interest under the GST act to the credit of purchaser. The same provisions shall be applicable in case of credit notes.
- 5.38.9 In case the successful tenderer is not liable to be registered under CGST/IGST/UTGST/SGST Act, The RailTel shall deduct the applicable GST from his/their bills under reverse charge mechanism (RCM) and deposit the same to the concerned tax authority.

5.39. MEASUREMENT OF WORKS

- 5.39.1 Please Refer Para 5.18 of tender document.
- 5.39.2 MEANING AND INTERPRETATION BY RAILTEL TO BE FINAL

All measurement, method of measurement, meaning an intent of specifications provided by purchaser's Engineer shall be final and binding.

5.40. TERMS OF PAYMENT

- 5.40.1.1 On Account Payment:-Ref para 4.46 of chapter-4.
- 5.40.1.2 Rounding off amounts:-Ref para 4.46 of chapter-4.
- 5.40.1.3 On account payments not prejudicial to final settlement:- Ref para 4.46 of chapter-4.
- 5.40.2 Manner of payment:- Ref para 4.46 of chapter-4.
- 5.40.3 ON ACCOUNT PAYMENT FOR SUPPLY OF EQUIPMENT & MATERIAL**

"On account payment" for supply of equipments, materials indicated in the schedule of requirements subject to recoveries of liquidated damages if any, shall not be made more than twice in a calendar month as given below.

- 5.40.3.1. 70% of the accepted cost of supply items (duly inspected by the nominated Inspection Authority) will be paid after following conditions by the consignee.
- On receipt of materials at site.
 - Original Inspection certificate issued by Inspecting Officer.
 - Challan / Invoice in duplicate.
 - A certificate that the materials supplied are as per the contract and the amount claimed in the invoice is correct as per terms of the contract.
 - Insurance policy for material (100% of the value of on account payment) as per Para 5.47 of tender document.

5.40.3.2 Additional 25 % of the accepted cost of supply items (in addition to the 70% released above) will be paid after completion of work in full Block & successful AT by representative of BBNL and issue of last Provisional Acceptance Certificate of the Block.

5.40.3.3 The balance 5% for each item will be paid after one year & issue of Final Acceptance Certificate from the date of issue of last PAC.

5.40.4 PROGRESS PAYMENT FOR EXECUTION OF WORK

On account progress payment shall be made as per following criteria.

5.40.4.1 70% (Seventy percent) of the On-Account/Progress payment for SOR item No.1 to 5 of schedule shall be made after successful completion of trenching /HDD/boring, duct laying, installation of route indicators, protection works of the routes after due measurement and testing/checking to the satisfaction of Engineer”

5.40.4.2 70% (Seventy percent) of the On-Account/Progress payment for SOR item No. 6 to 11 of schedule shall be made after successful completion of OFC laying, splicing, tapping, termination, installation of chambers, videography and supply of route diagram of the routes after joint measurement, testing and detailed checking to the satisfaction of Engineer.

5.40.4.3 **a.** 20% (Twenty percent) of the On-Account/progress payment shall be made after successful AT of cable works by issue of PAC.

b. 20% (Twenty percent) of the on account/progress payment shall be made after successful AT of completed cable works by issue of part PAC (as per Clause No. 5.26.2) of the subsection.

5.40.4.4 5% (five percent) of the On-Account/progress payment shall be made after successful commissioning of equipments.

5.40.4.5 If M/s BBNL imposes any penalty on account of bad workmanship or delays, the same shall be charged to the contractor back to back.

5.41 FINAL PAYMENT

5.41.1 Final payment of 5% (Five percent) of the contract value shall be made after issue of Final Acceptance Certificate (FAC).

5.41.2 **Post Payment Audit :-** It is an agreed term of contract that the RailTel reserves to itself the right to carry out a post-payment audit and or technical examination of the works and the final bill including all supporting vouchers, abstracts, etc., and to make a claim on the contractor for the refund any excess amount paid to him if as a result of such examination any over-payment to him is discovered to have been made in respect of any works done or alleged to have been done by him under the contract.

5.42 FINAL SETTLEMENT

On expiry of the warranty period and issue of the certificate of final acceptance of the entire installations, the Performance Bank Guarantee will be released to the Contractor after adjustment of any dues payable by the contractor.

5.43. CERTIFICATE FOR CENVAT BENEFITS ON BILLS

a) The purchaser will not be responsible for payment of taxes and duties paid by the supplier under misapprehensions of law or misclassification and in such cases even if the suppliers bill contain an element of tax or duty which is not payable by the purchaser, such payment would be disallowed.

b) The claim for ED, if any, on each bill should be supported by the following certificates:-

i) Certified that the amount of Rs.....claimed as ED in this bill is in accordance with the provision of the rules in all respects and the same has been actually paid to the excise authorities in respect of the stores covered by the bills.

ii) Quarterly certificate to the effect that no refund of ED already reimbursed against this contract has been obtained during the quarter ending. In the event of any such refund being obtained by the seller, the same should be passed on to the purchaser.

iii) Certificate: - The tenderers will have to give the following certificates in their offer:-

"We hereby declare that in quoting the above price, we have taken into effect, the full effect of the duty set-off on 'Central excise and

counter veiling duties' available under the existing scheme. We further agree to pass on such additional duties and set off as may become available in future in respect of all the inputs used for the manufacture of the final product, on the date of the supply under scheme, by way of reduction in price and advise the purchaser accordingly.”

- iv) Payment of excise duty will be released only after submission of excisable invoice to RailTel for availing CENVAT credit.

5.44. DEDUCTION FROM ON ACCOUNT PAYMENT BILLS

- (i) All costs, damages or expenses, which RailTel may have been paid or incurred which under the provisions of contract are Contractor's obligations will be deducted by RailTel from progress payment Bills/Invoice of Contractor, as and when it is understood that such an expense has been incurred or paid for.
- (ii) All such claims of RailTel shall, however, be duly supported by appropriate and certified vouchers, receipts or explanations as are available to enable the Contractor to identify such claims.

5.45. TAXES

- 5.45.1 The Contractor and all personnel employed by him shall pay such taxes like Income Tax as are payable under statutory laws of India and the Purchaser **WILL NOT ACCEPT** any liability for the same.
- 5.45.2 Deduction of Income Tax at source as per provisions of Finance Act and Income Tax in force shall be made from the Contractor/Sub-Contractor and the amount so deducted may be credited to the Central Government.
- 5.45.3 Wherever the law makes it statutory for the Purchaser to deduct any amount towards GST on Works Contract, the same will be deducted and remitted to the concerned authority.

5.46. MOBILIZATION ADVANCE

Deleted

5.47. INSURANCE

- 5.47.1 The Contractor shall take out and keep in force a policy or policies of insurance against all liabilities of the Contractor or the Purchaser at common law or under any statute in respect of accidents to persons who shall be employed by the contractor in or about the site for the purpose of carrying out the works on the site. The Contractor shall also take out and keep in force a policy or policies of Insurance against all recognized risks to their offices and depots. Such insurance shall in all respects be to the approval of the Purchaser and if he so requires in his name.

5.47.2 **INSURANCE OF MATERIALS & INSTALLATIONS**

The Contractor shall take out and keep in force a Policy or policies of Insurance for all materials including RailTel supply materials/ equipments irrespective of whether used up in the portion of work already done or kept for the use in the balance portion of the work until such works are provisionally handed over to the RailTel. For this purpose, the works are deemed to have been provisionally handed over when Last provisional acceptance certificate is issued for the locations.

5.47.3 The Contractor shall not be liable for losses/damages to the materials either used up in the portion of work done or his material kept for use at site, in consequence of Mutiny, or other similar causes over which the Contractor has no control and which cannot be insured. Such losses or damages shall be the liability of the Purchaser and if required by the Purchaser, be made good by the contractor at the cost of the Purchaser.

5.47.4 The Contractor should, however, insure the stores brought to site, against risks in consequence of war and invasion, as required under the Emergency Risk (Goods) Insurance Act enforce from time to time.

5.47.5 It may be noted that the beneficiary of the insurance policy should be RailTel or the policies should be pledged in favour of RailTel . The contractor shall keep the policy/policies current till the installations are provisionally handed over to the purchaser. It may also be noted that in the event of contractor's failure to keep the policy current and alive, renewal of policy will be done by purchaser for which the cost of the premium plus 20% of premium shall be recovered from the contractor.

5.47.6 For the purpose of enabling the contractor to take the insurance cover in connection with this contract, the purchaser's Engineer will advise the approximate price of all the RailTel supply materials to the Contractor.

5.48. **FORCE MAJEURE CLAUSE**

Ref para 4.11 of chapter -4.

5.48.1 Please Ref para 4.17 of chapter-4.

5.49 **SETTLEMENT OF DISPUTE AND ARBITRATION**

- (1) **Right of RailTel to determine the contract:-** The RailTel shall be entitled to determine and terminate the contract at any time should, in the RailTel's opinion, the cessation of work becomes necessary owing to paucity of funds or from any other cause whatever, in which case the value of approved materials at site and of work done to date by the Contractor will be paid for in full at the rate specified in the contract. Notice in writing from

the RailTel of such determination and the reasons therefore shall be conclusive evidence thereof.

- (2) **Payment on determination of contract:-** Should the contract be determined under sub Para 5.49(1) of tender document of this clause and the Contractor claims payment for expenditure incurred by him in the expectation of completing the whole of the work, the RailTel shall admit and consider such claims as are deemed reasonable and are supported by vouchers to the satisfaction of the Engineer. The RailTel's decision on the necessity and propriety of such expenditure shall be final and conclusive.
- (3) The Contractor shall have no claim to any payment of compensation or otherwise .Howsoever on account of any profit or advantage which he might have derived from the execution of the work in full but which he did not derive in consequence of determination of contract.



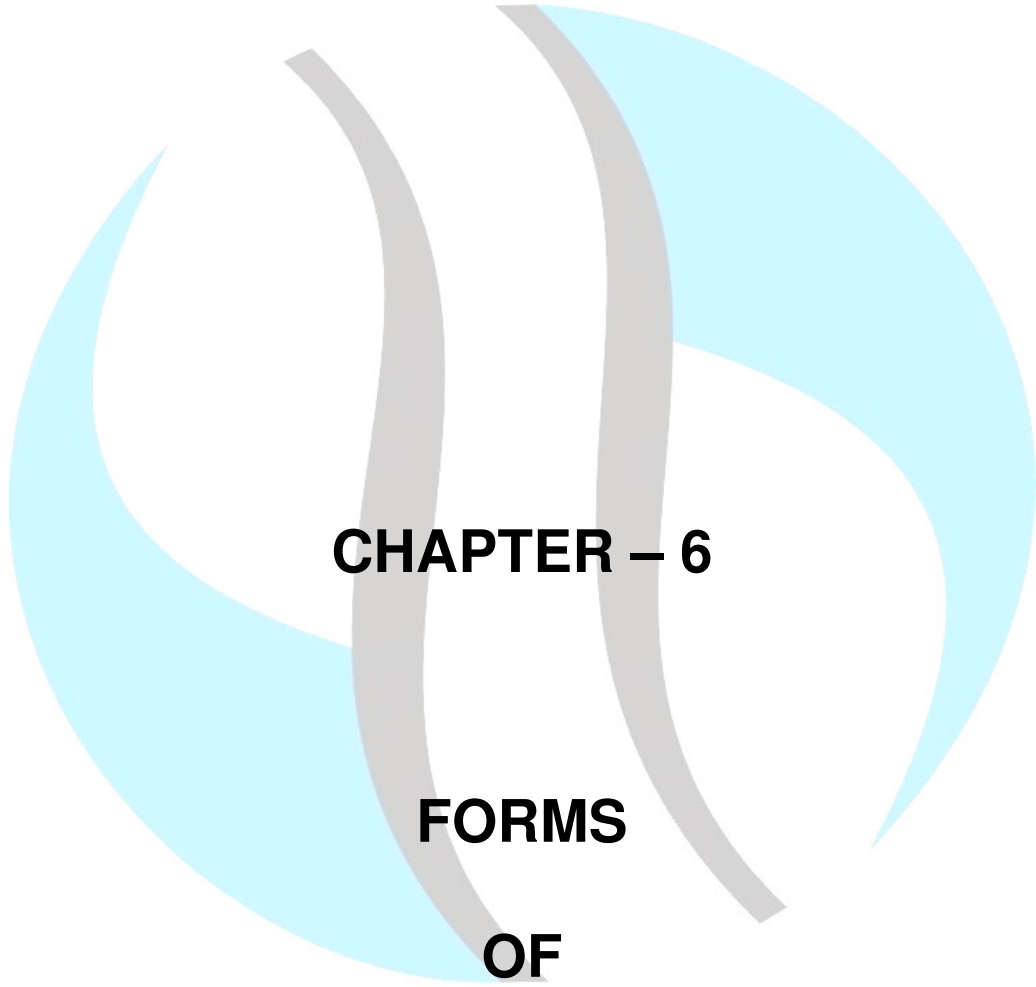

CHAPTER – 6

FORMS

OF

TENDER

रेलटेल
RAILTEL

A Government of India
Undertaking

CHAPTER – 6**FORMS OF TENDER**

Form No. 1	:	Offer Letter
Form No. 2	:	Qualifying Criteria / User's Certificate
Form No. 3	:	Agreement
Form No. 4	:	Proforma for Performance Guarantee Bond Deposit
Form No. 5	:	Statement of Deviations
Form No. 6	:	Not used
Form No. 7	:	Not used
Form No. 8	:	Not used
Form No. 9	:	Works in hand
Form No. 10	:	Not used
Form No. 11	:	Extension of period of completion of work
Form No. 12	:	Not used
Form No. 13	:	Qualification Experience
Form No. 14	:	Undertaking for compliance of Taxes/GST
Form No. 15	:	Vendor data sheet

रेलटेल
RAILTEL
 A Government of India
 Undertaking

Form No.1**OFFER LETTER**

From:

Date:

To:

Executive Director,
RailTel Corporation of India Limited,
Western Region,
Mumbai.

Sub: **Excavation of Trenches and laying of OFC through ducts, testing, commissioning and maintenance of OFC in the sections of 01 (One) Block (Porbandar) of Porbandar District of Gujarat State by RailTel on behalf of BBNL.**

Ref: Tender Notice No. RailTel/Tender/OT/WR/NOFN/2017-18/52 Dated 19.03.2018

I/We the undersigned hereby offer to execute the agreement for the above work within seven days from the date of issue of letter of acceptance of the tender in strict compliance within the provision detailed in the tender paper attached.

I/We agree that this tender shall not be restricted or withdrawn and shall remain opened for acceptance for and during the period of Ninety days from the date of opening of the tender.

I/We fully understand the terms and conditions as contained in the tender paper and we agree that the same shall apply to My/Our tender and I/We shall be bound by them.

Earnest money deposit Demand Draft/Pay Order/Banker's Cheque No.....Dated for Rs.....(Rupees only) drawn on (bank) in favour of "**NOFN EXPENDITURE CURRENT ACCOUNT WR.**", payable at Mumbai is enclosed.

The full value of the earnest money shall be forfeited without prejudice to any other right or remedies if:

- (i) If we do not submit the Performance Bank Guarantee/Security Deposit in the event the LOA for tender is awarded to us.
- (ii) I/We do not execute the contract document within 2 days after the receipt of notice by the RailTel Corporation that such documents are ready.
- (iii) I/We do not commence work within 7 Days from the date of issue of letter of acceptance.

(iv) If we withdraw our offer after opening of the tender.

(v) If we do not accept the order in the event the same is awarded to us.

Until a formal agreement is prepared and executed, submission of this offer letter shall constitute a binding contract between us subject to modification as may be mutually agreed to between us and indicated in the letter of acceptance of my/our offer.

I/We hereby agree to execute the OFC laying work and place our teams as required in the ----
---Blocks within the scheduled date mentioned above. In the event of shortcomings in the provision of equipment / placement of team within the stipulated date, RailTel shall be at liberty to impose penalty, if any, as has been stipulated in the tender document.

Yours Sincerely,

Signature & Seal of the Tenderer

Place: -

Date: -

Witnessed by:

1. Signature:

Name:

Address:

2. Signature:

Name:

Address:



QUALIFYING CRITERIA

USER'S CERTIFICATE

Name of the Firm					
Contract No. & date					
Scope of Work					
Contract Amount (in Indian Rupees)					
Completion Period as per original contract					
Completion Period with extension					
Data of Commencement					
Actual date of Successful Completion					

रेलटेल
RAILTEL

Name :
 Dated :
 Designation :

Signature of the Contractor with
Company Seal

Note: The relevant User's certificate to be attached.

A Government of India
 Undertaking

Form No. 3

AGREEMENT

(CA No. _____ for " Excavation of Trenches and laying of OFC through ducts, testing, commissioning and maintenance of OFC in the sections of 01 (One) Block (Porbandar) of Porbandar District of Gujarat State by RailTel on behalf of BBNL."

This AGREEMENT is made at Mumbai on this _____ day of _____ two thousand and _____, by and between RailTel Corporation of India Limited (A Govt. of India Undertaking) having its Registered Corporate office at 6th Floor, III Block, Delhi Technology Park, Shastri Park, Delhi-110053, and Western Railway Microwave Complex, opposite Ambika Mills, Senapati Bapat Marg, Mahalaxmi (West), Mumbai-400013 acting in the premises through Executive Director /Western Region (hereinafter referred to as 'RailTel', which expression should unless repugnant to the context or meaning thereof include its successors and permitted assigns) of the one part;

And _____ having its registered office at _____ acting in the premises through _____ (hereafter referred to as "Contractor", which expression should unless repugnant to the context or meaning thereof include its successor and permitted assigns) of the other part.

Whereas in response to a call for Tender by RailTel for the work of " Excavation of trenches & laying of OFC through ducts, testing and commissioning of OFC in the sections of-----Blocks of -----District(-----state) on behalf of BBNL" as per tender papers at Annexure 'A' read with Corrigendum..... Issued by RailTel hereto, the Contractor has submitted a Tender as per Annexure 'B' hereto

AND WHEREAS the said Tender of the Contractor has been accepted for the work of "Excavation of trenches & laying of OFC through ducts, testing and commissioning of OFC in the sections of----Block of -----District (----- state) on behalf of BBNL" as per copy of Letter of Acceptance of Tender No. _____ dated _____ complete with enclosures at the accepted rates and agreed deviations from tender papers as per Annexure-C hereto at contract value of Rs. _____ (Rupees _____ Only) duly accepted by the contractor.

Now this agreement witnesses that in consideration of the premises and the payment to be made by the Purchaser (RailTel) to the Contractor provided for herein, the Contractor shall supply all equipment and materials and execute and perform all works for which the said Tender of the Contractor has been accepted strictly according to the various provisions in Annexure 'B' and 'C' hereto and upon such supply, execute and performance to the satisfaction of the purchaser (RailTel) and the purchaser (RailTel) shall pay to the Contractor at the rates accepted as per the said Annexure 'C' and in terms of the provisions therein.

IN WITNESS whereof both the parties have hereunto set and subscribed their respective hands and/or seals on the day and year respectively mentioned against their respective

signatures.

Signed and delivered by Shri _____ for and on behalf of RailTel Corporation of India Ltd.

The contract within named in the presence of :

1. Signature :
Date :
Name in Block Capitals :
Address :

2. Signature :
Date :
Name in Block Capitals :
Address :

Signed and delivered by Shri. _____ for and on behalf of _____, the contractor within named in the presence of :

1. Signature :
Date :
Name in Block Capitals :
Address :

2. Signature :
Date :
Name in Block Capitals :
Address :

Annexure – A : Tender Paper No. _____ with corrigendum, if any.
Annexure – B : Firm's offer.
Annexure – C : Letter of Acceptance No. _____ with all enclosures.
Annexure – D : Copy of Contract Performance Guarantee.

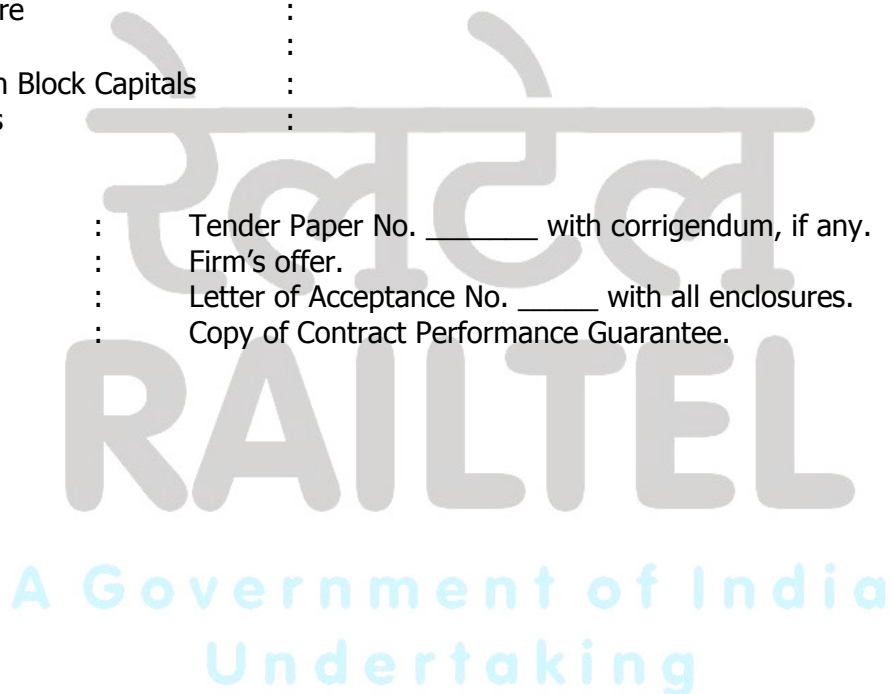

Form No. 4

CONTRACT PERFORMANCE GUARANTEE BOND

(On Stamp Paper of Rs one hundred)
(To be used by approved Scheduled Banks)

In consideration of the RailTel Corporation of India Limited, 6th Floor, III Block, Delhi Technology Park, Shastri Park, Delhi-110053 with Western Regional office at Western Railway Microwave Complex, Opposite Ambika Mills, Senapati Bapat Marg, Mahalaxmi (West), Mumbai-400013 (Herein after called the RailTel) having agreed to exempt (Hereinafter called "the said Contractor(s)") from the demand, under the terms and conditions of an Agreement No. dated made between RailTel Corporation of India Limited and for (hereinafter called "the said Agreement") of security deposit for the due fulfillment by the said Contractor(s) of the terms and conditions contained in the said Agreement, on production of a Bank Guarantee for Rs. (Rs. only). We, (indicate the name of the Bank) hereinafter referred to as "the Bank") at the request of Contractor(s) do hereby undertake to pay the RailTel an amount not exceeding Rs. against any loss or damage caused to or suffered or would be caused to or suffered by the RailTel by reason of any breach by the said Contractor(s) of any of the terms or conditions contained in the said Agreement.

We,(name of Bank) do hereby undertake to pay the amounts due and payable under this Guarantee without any demur, merely on demand from the RailTel stating that the amount as claimed is due by way of loss or damage caused to or would be caused to or suffered by the RailTel by reason of breach by the said Contractor(s) of any of terms or conditions contained in the said Agreement or by reason of the Contractor(s) failure to perform the said Agreement. Any such demand made on the Bank shall be conclusive as regards the amount due and payable by the Bank under this guarantee. However, our liability under this guarantee shall be restricted to an amount not exceeding Rs.only.

We,(name of bank) undertake to pay to the RailTel any money so demanded notwithstanding any dispute or disputes raised by the Contractor(s) / Supplier(s) in any suit or proceedings pending before any court or Tribunal relating thereto our liability under this present being, absolute and unequivocal.

The payment so made by us under this Bond shall be a valid discharge of our liability for payment there under and the Contractor(s) / Supplier(s) shall have no claim against us for making such payment.

We,(name of bank) further agree that the Guarantee herein contained shall remain in full force and effect during the period that would be taken for the performance of the said Agreement and that it shall continue to be enforceable till all the dues of the RailTel under or by virtue of the said Agreement have been fully paid and its claims satisfied or discharged or till RailTel certifies that the terms and conditions of the said Agreement have been fully and properly carried out by the said Contractor(s) and accordingly discharges this Guarantee. Unless a demand or claim under the Guarantee is made on us in writing on or before the

..... We shall be discharged from all liability under this Guarantee thereafter. We,.....(name of bank) further agree with the RailTel that the RailTel shall have the fullest liberty without our consent and without affecting in any manner our obligations hereunder to vary any of the terms and conditions of the Agreement or to extend time or to postpone for any time or from time to time any of the powers exercisable by the RailTel against the said contractor(s) and to forbear or enforce any of the terms and conditions relating to the said Agreement and we shall not be relieved from our liability by reason of any such variation, or extension to the said Contractor(s) or for any forbearance, act or omission on the part of RailTel or any indulgence by the RailTel to the said Contractor(s) or by any such matter or thing whatsoever which under the law relating to sureties would, but for this provision, have affect of so relieving us.

This Guarantee will not be discharged due to the change in the Constitution of the Bank or the Contractor(s)/ Supplier(s).

We (the name of Bank) lastly undertake not to revoke this Guarantee during its currency except with the previous consent of the RailTel in writing.

NOT WITH STANDING ANYTHING CONTAINED HEREIN ABOVE

- (i) The liability of the surety under his Bank Guarantee shall not exceed Rs..... (Rupees only).
- (ii) This Bank guarantee shall be valid upto
- (iii) We are liable to pay the guaranteed amount or any part thereof under this Bank Guarantee only and only if you serves upon the bank, written claim or demand on or before

Dated theday of 20.....

for
(Indicate the name of the Bank)

Witness :

Signature :
Name :

Signature :
Name :

NOTE: The Guarantee shall be valid for a period of 60 days after the expiry of the warranty period of the work as per Clause 3.17 of chapter 3.

A Government of India
Undertaking

Form No. 5

STATEMENT OF DEVIATIONS**PROFORMA FOR STATEMENT OF DEVIATIONS**

1. The following are the particulars of deviations from Preamble, requirement of the Instructions to Tenderers and Conditions of Tendering and Special conditions of Contract.

Preamble (Chapter 1)

<u>Clause</u>	<u>Deviation</u>	<u>Remarks (including justification)</u>
---------------	------------------	--

Instructions to Tenderers and Conditions of Tendering (Chapter 3)

<u>Clause</u>	<u>Deviation</u>	<u>Remarks (including justification)</u>
---------------	------------------	--

Special Conditions of Contract (Chapter 5)

<u>Clause</u>	<u>Deviation</u>	<u>Remarks (including justification)</u>
---------------	------------------	--

2. The following are the particulars of deviations from requirement of the **Technical specifications and instruction for trenching and laying of optical fiber and special protective work (Chapter 7)**

<u>Clause</u>	<u>Deviation</u>	<u>Remarks (including justification)</u>
---------------	------------------	--

The following are the particulars of deviations from requirement of the **Drawings (Chapter 8)**

<u>Clause</u>	<u>Deviation</u>	<u>Remarks (including justification)</u>
---------------	------------------	--

Note: Where there is no deviation, the statement should be returned duly signed with an endorsement indicating "no deviations".

SIGNATURE AND SEAL OF THE
TENDERER

WORKS IN HAND

SI No	System & Name of the Project	Party's name & address for whom the work is being done	Total Contract Value	Schedule period of execution (in months)	%age progress in terms of work already done	Likely date of completion	No. of extensions granted	Payments received till date	Remarks

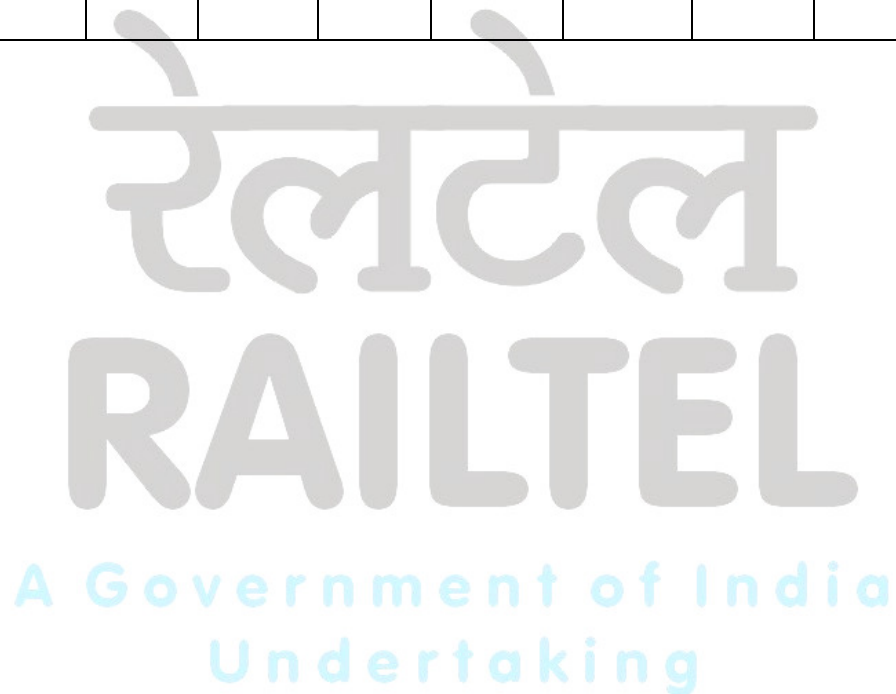

Form No. 11

EXTENSION OF PERIOD OF COMPLETION OF WORK

Ref No. : RCIL/.....

Date :

To,

Sub: (i) Name of Work
(ii) Acceptance Letter No.
(iii) Agreement No.

Ref: Quote specific application of the Contractor for extension to date, if received).

Dear Sir,

The stipulated date for completion of the work mentioned above is _____. From the progress made so far and the present rate of progress, it is unlikely that the work will be completed by the above date (or However, the work was not completed on this date)

Expecting that you may be able to complete the work if some time is given the Director / POM RailTel Corporation of India Limited, New Delhi although not bound to do so, hereby extends the time for completion from _____ to _____ .

* In consideration of the circumstances explained in your letter of request RailTel has extended the completion period by Days without any liquidated damages. Please ensure the completion and commissioning of the project well within the extended period.

* Please note that an amount equal to @0.5% for each week of delay or part thereof for a period up to ten weeks and thereafter at the rate of 0.7% for each week of delay or part thereof for another ten weeks subject to a maximum of 12% of the total contract value of the works as a recovery for delay in the completion of the work after the expiry of (1) will be recovered from as mentioned in clause 5.35 chapter V of the special conditions of contract for the extended period notwithstanding the grant of this extension. You may proceed with the work accordingly.

The above extension of the completion date will also be subject to the further condition that no increase in rates on any account will be payable to you.

Please intimate within a week of the receipt of this letter your acceptance of the extension on the conditions stated above.

Please note that in the event of declining to accept the extension on the above said conditions

or, in the event of your failure after accepting or acting up to this extension to complete the work by (2) _____ (here mention the extended date), further action will be taken in terms of relevant clause of special conditions of contract.

Yours faithfully,

for & on behalf of RailTel Corporation of India Limited

Note:

Give here the stipulated date for completion without any penalty fixed earlier.

Here mention the extended date.

Strike out one of the * clauses as applicable.



QUALIFICATION & EXPERIENCE

Details of works executed and under execution by Tenderer during the last 5 years should be furnished in the following format.

Sl No	Name of Project & Description of work	Party's name & address for whom the work was done	Total Value of the Contract (in Rs)	Date of award of work and schedule period of execution (in months)	Date of completion and actual period of execution (in months)	Remarks

Note : A certificate from the organization for whom the work was executed should be submitted to indicate that the contract was satisfactorily executed.

(Signature and Seal of the Manufacturer / Contractor)



Form-14

Undertaking for compliance of Taxes/GST**(On the Letter-Head of Supplier/Tenderer)**

I/We, _____ (Name of Proprietor/Karta/Partner/Director) of _____ (Name of Entity), am/are aware that provision of GST has be implemented from 01st July, 2017. Same would result in revision of all Purchase Orders/LOA in respect of which Services be rendered under GST Regime. I agree to abide by all Terms and Conditions in Tender/Purchase Orders relating to statutory duties/taxes and changes thereto, and provisions of GST relating to anti-profiteering. Also, that I/we are aware/understand that Terms & Conditions of Tender may undergo change to bring the same in alignment with GST, and undertake to abide by same.

Tender No.: _____

LOA: _____

Name Of Work : _____

Signature: _____

Designation: _____

Date: _____

Seal: _____



Vendor Data Sheet

Form -15

Contact Details					RCM Details	Type of Supply	GST Credentials			Details of Goods with HSN Classification		Details of Services with SAC		Composition On Dealer	Exemptions
Title	Company Name	Registered Address (As per GST)	Region (State, Province, Country)	E-Mail Address	Whether tax is payable on reverse charge basis	Taxable Supply / Non-Taxable Supply / Composite Levy	Permanent Account No (PAN)	GST IN / Provisional Identification No	Description of Goods	HSN	Description of Service	SAC	Whether registered under composition Scheme ?	Whether covered under any exemption ? If yes please specify	



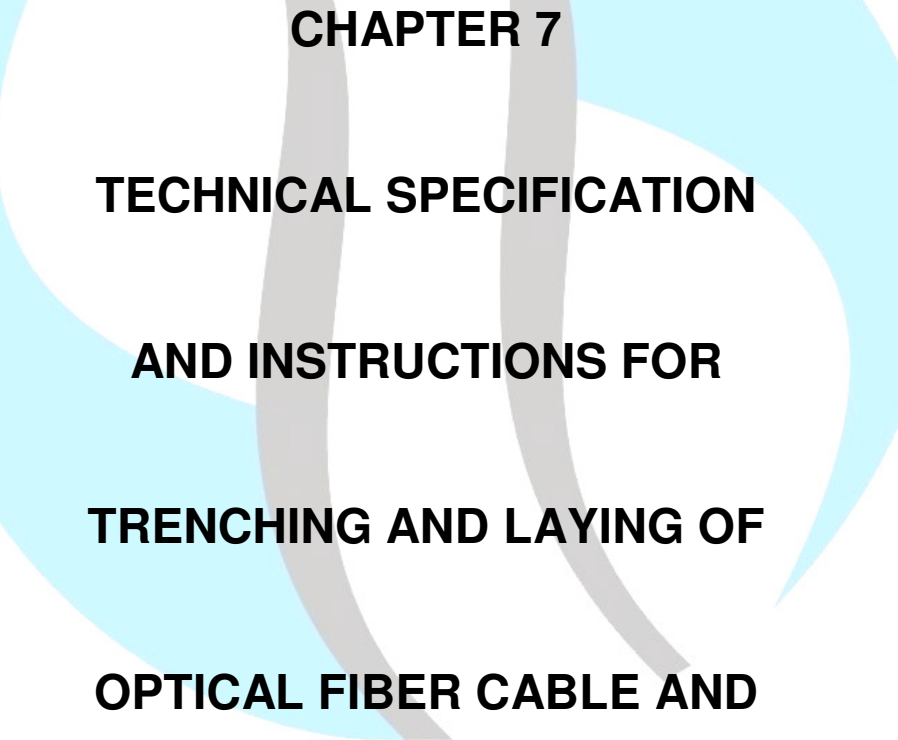

CHAPTER 7

TECHNICAL SPECIFICATION

AND INSTRUCTIONS FOR

TRENCHING AND LAYING OF

OPTICAL FIBER CABLE AND

SPECIAL

PROTECTIVE WORKS

रेलटेल

RAILTEL

A Government of India
Undertaking

Para No.	Subject
7.1	Scope
7.2.	Introduction
7.3	Optical Fiber Cable laying approach
7.4	General
7.5	Excavation of tranches
7.6	Laying of PLB HDPE Ducts
7.7	Back Filling and Dressing of the Trench
7.8	Cable Pulling and joining / splicing
7.9	Construction of Jointing Chamber
7.10	Fixing of Route Indicators / Joint Indicators
7.11	Documentation
7.12	Safety precautions
7.13	Allied activities
7.14	Techniques for Jointing of Fiber Optic Cable
7.15	Tools
7.16	Supplementary Engineering Instructions

Engineering Instructions

7.1 SCOPE

7.1.1 The Engineering Instructions spelt out in this document deal with the methods to be adopted for underground Optical Fiber Cable laying in PLB HDPE ducts and inter connection of the existing Optical Fiber Cables with the newly laid OF cables and termination of OF Cables at Gram Panchayats(GPs) for National Optical Fiber Network.

7.2 INTRODUCTION

7.2.1 The existing core Optical Fiber Cable (OFC) network already deployed by various service providers mostly covers State/District/Block headquarter but does not extend upto most of the Gram Panchayats. Under the NOFN project all 250000 Gram Panchayats across the country are proposed to be connected to the Block HQs by laying incremental Optical Fiber Cable.

7.3 OF CABLE LAYING APPROACH

7.3.1 On the basis of the survey reports routes for OF cable laying shall be finalized. Road Cutting Permission shall be obtained from road and rail authorities for laying the Optical Fiber Cable along the finalized roads and at rail / road crossing along the route. Generally O.F. Cable may preferably be laid straight as far as possible along the road near the boundaries, away from the burrow pits. When the O.F. Cable is laid along the National Highways, Cable should run along the road land boundary or at a minimum distance of 15 meters from the center line of the road where the road land is wider as the OFC carries high capacity traffic and is planned for about 25 to 30 years of life. It is essential that the cable is laid after obtaining due permission from all the concerned authorities to avoid any damage (which may result in disruption of services / revenue loss) and shifting in near future due to their planned road widening works.

7.3.2 In special cases where it may be necessary to avoid burrow pits or low lying areas, the Cable may be laid underneath the shoulders at a distance of 0.6 meter from the outer edge of the road embankment provided the same is located at least 4.5 meters away from centre line of road.

7.4 GENERAL

7.4.1 Soil Classification

Soil shall be classified under two broad categories Rocky and Non Rocky, The soil is categorized as rocky if the cable trench cannot be dug without blasting and / of chiseling. All other types of soils shall be categorized as Non Rocky including Murrum & soil mixed with stone or soft rock.

1. Rocky soil

The terrain which consists of hard rocks or boulders where blasting/ chiseling is required for trenching such as quartzite, granite, basalt in hilly areas and RCC (reinforcement to be cut through but not separated) and the like.

2. Non Rocky soils

This will include all types of soil- soft soil/hard soil/murum ie. any strata, such as sand, gravel, loam, clay, mud, black cotton murum, shingle, river or nullah bed boulders, soling of roads, paths etc. (All such soils shall be sub-classified as **kachcha soil**) and hard core, macadam surface of any description (water bound, grouted tarmac etc), CC roads and pavements, bituminous roads, bridges, culverts(All such soils shall be classified as **Pucca soils**)

7.4.2 The Optical Fibre Cable shall be laid through PLB HDPE Ducts buried at a nominal depth of 165cms. The steps involved in OF Cable construction are as under

7.4.2.1 Excavation of trench up to a nominal depth of 165 cms **in non-Rocky soil**, according to construction specification along National/State Highways/other roads and in built up /rural areas. Under exceptional conditions/ genuine circumstances due to site constraints/ soil conditions, relaxation can be granted by the competent authority for excavation of trench to a depth lesser than 165 cm. Such relaxation shall be given as per the laid down norms/procedures being followed by the concerned CPSUs for their own works and with the approval of the competent authority. The payment in such cases shall be made on pro-rata basis as per the existing norms adopted by the concerned CPSUs.

7.4.2.2 Laying of PLB HDPE Ducts/coils coupled by sockets in excavated trenches, on bridges and culverts, as per construction specification and sealing of PLB HDPE Ducts pipe ends at every manhole by end-plugs of appropriate size.

7.4.2.3 Providing additional protection by RCC Pipes/GI pipes and/or concreting/chambering, wherever required according to construction specification.

7.4.2.4 Fixing of GI pipes/troughs with clamps on culverts/bridges and/or chambering or concreting of G.I. Pipes/troughs, wherever necessary. Normally , RCC/DWC pipes shall be used and use of GI pipes shall be avoided. However, in case it is felt that GI pipe is unavoidable in certain circumstances this should be done with the prior approval of competent authority within the concerned CPSUs. This shall be recorded appropriately.

7.4.2.5 **Laying Protection Pipes On Bridges And Culverts.**In case trenching and pipe laying is not possible on the culverts, the pipes shall be laid on the surface of the culverts/bridges after due permission from the competent authority **as per construction specification**

7.4.2.6 Back filling and Dressing of the Trench according to construction specifications.

7.4.2.7 Making manhole (of size 2.0 m length x 1.0 m width x 1.65 m Depth) at every Cable pulling location for housing the OF Cable loop & Pulling Optical Fibre Cable using proper tools and accessories. Sealing of both ends of the PLB

HDPE pipe in manhole by hard rubber bush of suitable size to avoid entry of rodents into the PLB HDPE Ducts, putting split PLB HDPE Ducts and split RCC pipes with proper fixtures over cable in the manhole to protect the bare cable.

7.4.2.8 Digging of pit of size 2 meter x 2 meter x 1.8 meter (depth) for fixing of Jointing chamber pre-cast RCC cover or stone of suitable size on Jointing chamber to protect the Joint and backfilling of jointing chamber with excavated soil.

7.4.2.9 Digging of pits 500 cm to 1000 cm towards jungle side at every manhole and jointing chamber along the route to a depth of 75 cms., fixing of route Indicator/joint indicator, concreting and backfilling of pits. Painting of route indicators with Blue colour and joint Indicator by Grey colour and sign writing denoting route/joint indicator number and marked as "BBNL", as per construction specification.

7.4.3 Specifications of Materials to be used

7.4.3.1 PLB HDPE Duct

Optical Fiber Cables should be pulled through Permanently Lubricated HDPE Duct of 40mm/33 mm size conforming to the specifications as per TEC GR No. TEC/GR/TX/CDS-008/03/MAR-11 with latest Amendments. The Ducts shall be blue in colour and have the identification markings as per TEC GR wherein BBNL logo shall be marked as purchaser's name.

7.4.3.2 PLB HDPE Duct Accessories

a) Push fit Coupler

Push Fit couplers shall be used for coupling PLB HDPE ducts/coils. The specifications of the couplers shall be as per TECGR no TEC/GR/TX/CDS-008/03/Mar11 with latest amendments.

b) End Cap

End Cap shall be used for sealing the ends of the empty ducts, prior to installation of the OF Cable and shall be fitted immediately after laying the duct to prevent the entry of any dirt, water, moisture, insects/rodents etc. It should conform to TEC GR No. TEC/GR/TX/CDS-008/03/MAR-11 with latest amendments. The ends of the PLB HDPE ducts/coils laid in the manholes should be closed with End Caps. The End Caps used should be suitable for closing 40mm/33mm PLB HDPE ducts/coils. A suitable arrangement should be provided in the End Cap to tie PP Rope. (See figure-1 for details)

c) Cable sealing Plug

This shall be used to seal the end of the ducts perfectly, after the OF cable is pulled in the duct. For pulling the cable through the ducts, it is necessary to provide manholes at that location and also at bends and corners wherever required. The ends of the PLB HDPE ducts/coils are closed with Cable sealing Plugs. The End Plugs used should be suitable for closing 40mm/33mm PLB HDPE ducts/coils. The Cable sealing plug shall conform to TEC GR No. TEC/GR/TX/CDS-008/03/MAR-11 with latest amendments. (Wherever blowing technique is used for laying OF Cable, the hand holes/manholes required for

accessing the cable during cable laying can be at longer distances depending upon requirement.)

7.4.3.3 Material for Providing Additional Protection

a) **RCC Full Round Pipes**

Reinforced cement concrete pipes (spun type) coupled with RCC collars sealed with cement mortar used to provide additional protection to PLB HDPE Ducts/coils at lesser depths should be of full round, NP-2 class and size 100 mm (internal diameter), conforming to IS standard 458-1988 with latest amendments. The pipes should have a nominal length of 2 meters.

The RCC collars should be properly sealed using cement mortar 1:3 (1:53 grade cement of reputed brand, 3: fine sand without Impurities). In case of long spans, every third joint will be embedded in a concrete block of size 60 cms (L) x 40cms (W) x 25 cms (H) of 1:2:4 cement concrete mix (1: cement, 2: coarse sand, 4: stone aggregate of 20 mm nominal size) so that the alignment of RCC pipes remain firm and intact. Also, both ends of RCC pipes spans will be sealed by providing concrete block of size 40 cm (L) x 40 cm(W) x 25 cm (H) of 1:2:4 cement concrete mix to avoid entry of rodents.

b) **RCC Split Pipes**

The split Reinforced cement concrete pipes (spun type) with in-built collars are used to provide additional protection to PLB HDPE Ducts/coils should be of 100 mm internal dia.(Spigotted), Class--NP-3, Thickness: 25 mm, Length: 2 Meters with inbuilt collar at one end, Conforming to ISI Specification IS: 458, 1988 with latest amendment

c) **G.I. Pipes**

G.I. pipes should be of medium duty class having inner diameter of 50 mm with threads on one end and socketed on one end. The GI pipe should conform to specifications as per IS 1239 (Part-2) : 2011 (revised upto date) for tube and sockets and IS 554:1999 (revised upto date) for pipe threads. The pipe shall be procured with socket at one end and threads at the other.

d) **DWC Pipes**

Use of normal duty DWC (Double walled corrugated) HDPE pipe – conforming to table 2 of TEC GR no.GR/DWC-34/01 Sep.2007 with latest amendments shall be preferably utilized as first choice for protection of Optical Fiber Cable instead of GI pipes. The DWC pipes dimensions are as:

- i) Nominal size = 75 mm
- ii) Outside Diameter = 75 mm
- iii) O. D. Tolerance = + 1.4 mm
- iv) Minimum Inside diameter = 56 mm

e) **M.S. Weld Mesh**

The PLB HDPE Ducts can also be protected by embedding it in concrete of size of 25 cms x25 cms reinforced with MS weld mesh. The MS weld mesh used should be of 50 mm x 100 mm size, 12 SWG, 120 cms in width in rolls of 50m

each. One meter of MS weld mesh caters to approx. 3 meters of concreting. (See figure '2' for details)

The strength of RCC/CC is dependent on proper curing, therefore, it is imperative that water content of CC/RCC mix does not drain out into the surrounding soil. In order to ensure this, the RCC/CC work should be carried out by covering all the sides by yellow PVC sheets of weight not less than 1 kg per 8 sqm to avoid seepage of water into the soil.

7.4.3.4 Joint Chamber

The Joint chamber shall be provided at every joint location to keep the OF cable joint well protected and also to house extra length of cable which may be required in the event of faults at a later date. The Joint chamber shall be of pre-cast RCC type as per construction specification. Brick chamber can also be made with prior permission of Engineer in-charge.

7.4.3.5 Rubber Bush

To prevent entry of rodents into PLB HDPE DUCTS, the ends of PLB HDPE DUCTS are sealed at every manhole and joint using rodent resistant hard rubber bush (cap) after optical fibre cable is pulled. The rubber bush should be manufactured from hard rubber with groove sand holes to fit into 40 mm PLB HDPE DUCTS pipe, so that it should be able to prevent the entry of insects, rodents, mud, and rainwater into the PLB HDPE DUCTS pipe. It should conform to TEC GR with latest amendments. (see Figure-3)

7.4.3.6 Route/Joint Indicator

The Route/Joint indicators are co-located with each manhole/joint chamber. In addition Route indicators are also to be placed where route changes direction like road crossings etc. Either RCC/Pre-cast or Stone based route indicators can be used. The detailed specification and design of the same shall be as per construction specification. Generally, Stone Route indicators shall be used for the NOFN project

CONSTRUCTION SPECIFICATIONS

7.5 EXCAVATION OF TRENCHES

7.5.1 Trenching

7.5.1.1 Location and Alignment of the Trench

In built up areas, the trench will normally follow the foot-path of the road except where it may have to come to the edge of the carriage way cutting across road with specific permissions from the concerned authorities maintaining the road (such permissions shall be obtained by the department as per MOU signed with respective State Govt.). Outside the built up limits the trench will normally follow the boundary of the roadside land. However, where the road side land is full of burrow pits or affore station or when the cable has to cross culverts/ bridges or streams, the trench may come closer to the road edge or in some cases, over the embankment or shoulder of the Road (permissions for such deviations for cutting the embankment as well as shoulder of the road shall be obtained).

The alignment of the trench will be decided by a responsible official of RailTel.

Once the alignment is marked, no deviation from the alignment is permissible except with the approval of Engineer-in-charge. While marking the alignment only the centre line will be marked and the Contractor shall set out all other work to ensure that, the excavated trench is as straight as possible. The Contractor shall provide all necessary assistance and labour, at his own cost for marking the alignment. Contractor shall remove all bushes, under growth, stumps, rocks and other obstacles to facilitate marking the centre line without any extra charges. It is to be ensured that minimum amount of bushes and shrubs shall be removed to clear the way and the contractor shall give all, consideration to the preservation of the trees.

The line up of the trench must be such that PLB pipe(s) shall be laid in a straight line, both laterally as well as vertically except at locations where it has to necessarily take a bend because of change in the alignment or gradient of the trench, subject to the restrictions mentioned else where.

7.5.1.2 Line-Up

The line-up of the trench must be such that PLB HDPE Ducts shall be laid in a straight line except at locations where it has to necessarily take a bend because of change in the alignment or gradient of the trench, subject to the restrictions mentioned elsewhere.

7.5.2 Method of Excavation

In built up areas, the contractor shall resort to use of manual labour / HDD only to ensure no damage is caused to any underground or surface installations belonging to other public utility services and/or private parties.

However, along the Highways and cross country there shall be no objection to the Contractor resorting to mechanical means of excavation, provided that no underground installations exist in the path of excavation, if any, are damaged.

Undertaking

There shall be no objection to resort to horizontal boring to bore a hole of required size and to push through G.I. Pipe (50 mm ID) through horizontal bore at road crossing or rail crossing or small hillocks etc.

All excavation operations shall include excavation and 'getting out'. 'Getting out' shall include throwing the excavated materials at a distance of at least one meter or half the depth of excavation, whichever is more, clear off the edge of excavation. In all other cases 'getting out' shall include depositing the excavated materials as specified.

In Rocky strata excavation shall be carried out by use of electro mechanical means like breakers/ jack hammers or by blasting wherever permissible with express permission from the competent authority. If blasting operations are prohibited or not practicable, excavation in hard rock shall be done by chiseling/ jack hammers.

Trenching shall as far as possible be kept ahead of the laying of pipes. Contractor shall exercise due care that the soil from trenching intended to be loose for back filling is not mixed with loose debris. While trenching, the Contractor should not cause damage to any underground installations belonging to other agencies and any damage caused should be made good at his own cost and expense.

Necessary barricades, night lamps, warning board and required watchman shall be provided by the contractor to prevent any accident to pedestrians or vehicles. While carrying out the blasting operations, the contractor shall ensure adequate safety by cautioning the vehicular and other traffic. The contractor shall employ sufficient man-power for this with caution boards, flags, sign writings etc.

The contractor should provide sufficient width at the trench at all such places, where it is likely to cave in due to soil conditions without any extra payment. A minimum free clearance of 15 cms should be maintained above or below any existing underground installation. No extra payment will be made towards this. In order to prevent damage to PLB HDPE DUCTS over a period of time, due to the growth of trees, roots, bushes, etc., the contractor shall cut them when encountered in the path of alignment of trench without any additional charges.

In large burrow pits, excavation may be required to be carried out for more than 165 cms in depth to keep gradient of bed less than 15 degrees with horizontal. If not possible as stated above, alignment of trench shall be changed to avoid burrow pit completely.

7.5.3 Depth and Size of the Trench

The depth of the trench from top of the surface shall not be less than 165 cms unless otherwise relaxation is granted by competent authority under genuine circumstances.

In rocky terrain, less depth shall be allowed only in exceptional circumstances with additional protection where it is not possible to achieve the normal depth due to harsh terrain/adverse site conditions encountered. This shall be done only with the prior approval of the competent authority and consent of the Engineer in-charge after following the laid norms and procedures being followed

in the CPSUs concerned. This shall be properly documented. In all cases, the slope of the trench shall not be less than 15 degrees with the horizontal surface. The width of the trench shall normally be 45 cms at the top & 30 cms at the bottom.

In case, additional pipes (HDPE/GI/RCC Pipes) are to be laid in some stretches, the same shall be accommodated in this normal size trench.

When trenches are excavated in slopes, uneven ground, inclined portion, the lower edge shall be treated, as top surface of land and depth of trench will be measured accordingly. In certain locations, such as uneven ground, hilly areas and all other Places, due to any reason whatsoever it can be ordered to excavate beyond standard depth of 165 cms to keep the bed of the trench as smooth as possible. Near the culverts, both ends of the culverts shall be excavated more than 165 cms. to keep the gradient less than 15 degree with horizontal. For additional depth in excess of 165 cms., no additional payment shall be applicable.

If excavation is not possible to the minimum depth of 165 cms., as detailed above, full facts shall be brought to the notice of the Engineer in charge in writing giving details of location and reason for not being able to excavate that particular portion to the minimum depth. Approval shall be granted by the competent authority in writing under genuine circumstances. The decision of the competent authority shall be final and binding on the contractor.

7.5.3.1 Dewatering: The Contractor shall be responsible for all necessary arrangements to remove or pump out water from trench. The Contractor should survey the soil conditions encountered in the block and make his own assessment about dewatering arrangement that may be necessary. No extra payment shall be admissible for this.

7.5.3.2 Wetting: Wherever the soil is hard due to dry weather conditions, if watering is to be done for wetting the soil to make it loose, the same shall be done by the contractor. No extra payment shall be admissible for this.

7.5.3.3 Blasting: For **excavation in hard rock**, where blasting operations are considered necessary, the contractor shall obtain approval of the Engineer-in-Charge in writing for resorting to blasting operation. The contractor shall obtain license from the competent authority for undertaking blasting work as well as for obtaining and storing the explosive as per the Explosive Act, 1884 as amended upto date and the explosive Rules, 1983. The contractor shall purchase the explosives fuses, detonators, etc. only from a licensed dealer. Transportation and storage of explosive at site shall conform to the aforesaid Explosive Act and Explosive Rules. The contractor shall be responsible for the safe custody and proper accounting of the explosive materials. Fuses and detonators shall be stored separately and away from the explosives. The Engineer-in-Charge or his authorized representative shall have the right to check the contractor's store and account of explosives. The contractor shall provide necessary facilities for this. The contractor shall be responsible for any damage arising out of accident to workmen, public or property due to storage, transportation and use of explosive during blasting operation. Blasting operations shall be carried out

under the supervision of a responsible authorized agent of the contractor (referred subsequently as agent only), during specified hours as approved in writing by the Engineer-in-Charge. The agent shall be conversant with the rules of blasting. All procedures and safety precautions for the use of explosives drilling and loading of explosives before and after shot firing and disposal of explosives shall be taken by the contractor as detailed in **IS: 4081** safety code for blasting and related drilling operation.

7.5.3.4 Trenching Near Culverts/ Bridges: The PLB HDPE Ducts shall be laid in the bed of culvert at the depth not less than 165 cms protected by RCC pipes as decided by Engineer- in charge. Both ends of culverts shall be excavated more than 165 cms in depth to keep the gradient of not less than 15 degree with horizontal. The bed of trench should be as smooth as possible.

7.5.3.5 While carrying out the work on bridges and culverts, adequate arrangement for cautioning the traffic by way of caution boards during day time and danger lights at night shall be provided. In case of small bridges and culverts, where there is a likelihood of their subsequent expansion and remodeling, the cable should be laid with some curve on both sides of the culvert or the bridge to make some extra length available for readjustment of the cable at the time of reconstruction of culvert or the bridge.

7.6 Laying OF PLB HDPE Ducts

After the trench is excavated to the specified depth, the bottom of the trench has to be cleared of all stones or pieces of rock and leveled up properly. A layer of soft soil/or sand (in case the excavated material contains sharp pieces of rock/stones) of not less than 5 cms is required for leveling the trench to ensure that the cable when laid will follow a straight alignment. Adequate care shall be exercised while laying so that the OF cables are not put to undue tension/pressure after being laid as this may adversely affect the optical characteristics of cables with passage of time.

The contractor shall ensure that trenching and pipe laying activities are continuous, without leaving patches or portions incomplete in between. In case intermediate patches are left, measurement of the completed portions will be taken only after work in such left over patches are also completed in all respects.

Preparatory to aligning the pipe for jointing, each length of the PLB HDPE Ducts shall be thoroughly cleaned to remove all sand, dust or any other debris that may clog, disturb or damage the optical fibre cable when it is pulled at a later stage. The ends of each pipe and inside of each Socket shall be thoroughly cleaned of any dirt or other foreign materials.

After the trench is cleaned the PLB HDPE Ducts/coil shall be laid in the cleaned trench, jointed with Sockets. Drawing up of PP rope is optional as per TEC GR. In case of use of PP rope ,at every manhole approximately at every 200 m or at bends or turns the PP rope will be tied to the HDPE end caps used for sealing the PLB Ducts, to avoid entry of rodents/mud etc.

At the end of each day work, the open ends of the pipes sections shall be tightly closed with end caps to prevent the entry of dirt/mud, water or any foreign matter into PLB HDPE Ducts until the work is resumed.

In built up area falling within Municipal/Corporation limits, the PLB HDPE Ducts shall be laid with protection using RCC Pipes/ Concreting reinforced with weld mesh (only in exceptional cases).

For lesser depths requiring additional protection in built up areas, towns and cities falling within the municipal limits, suitable protection shall be provided to PLB HDPE pipes/coils using RCC/DWC full round/split pipes or GI pipes or cement concreting reinforced with MS weld mesh or a combination of any of these as per the site requirement. This shall be done only with the prior instructions/approval of the Engineer-in-charge. The specifications for providing each of these protections are given later in this document.

Moreover, in cross country routes, if depth is less than 1.2 meters, protection by using RCC/DWC Pipe shall be provided. Engineer-in-Charges shall decide about such stretches and type of protection to be provided in view of the site requirements. Normally 100 mm RCC /DWC Pipes shall be used for protecting PLB HDPE Ducts but if more than one PLB pipe is to be laid and protected, RCC/DWC Pipe of suitable size to accommodate the required number of PLB Pipes shall be used.

The PLB HDPE Ducts shall be laid in RCC Full Round spun Pipes/GI Pipes as required at Road crossings. The RCC pipes/GI pipes shall extend at least 3 meters on either side of the road at Road crossings. At Road crossings, extra GI/PLB HDPE Ducts may be laid as per the direction of the Engineer-in charge. On Rail bridges and crossings, the PLB HDPE Ducts shall be encased in suitable cast iron as prescribed by the Railway Authorities.

Wherever RCC pipes are used for protection, the gaps between the RCC collars and the RCC pipes shall be sealed using cement mortar 1:3 (1:53 grade cement of reputed brand, 3: fine sand without impurities) to bar entry of rodents. Every third collar of RCC pipes (normally of 2 meters length) and also both ends of RCC Pipes will be embedded in a concrete block of size 40 cms (L)x 40 cms(W) x 25 cms (H) of 1:2:4 cement concrete mix (1:53 grade cement of reputed brand, 2: coarses and, 3: stone aggregate of nominal size of 20 mm) so that the alignment of RCC pipes remain firm and intact and to avoid entry of rodents.

Wherever GI pipes are used, special care should be taken to ensure that G.I. Pipes are coupled properly with the sockets so as to avoid damage to PLB pipe and eventually the OF Cable in the event of pressure coming on the joint and G.I. Pipe joint giving its way. Rubber bushes shall be used at either ends of the GI pipes to protect PLB pipe. Both the ends of G.I. Pipe will be embedded in a concrete block of size 40 cms (L)x 40 cms ((W) x 25 cms (H) of 1:2:4 cement concrete mix(1:53 grade cement of reputed brand, 2: coarse sand, 3: stone aggregate of nominal size of 20 mm)so that the alignment of G.I. Pipes remain firm and intact and to avoid entry of rodents.

Undertaking

In case of protection by concreting at site, the nominal dimension of concreting shall be 250 mm x250 mm section. Cement Concrete Mixture used shall be of 1:2:4 composition i.e. 1:53 grade Cement of a reputed company , 2: Coarse Sand, 4: Graded Coarse Stone aggregate of 20 mm nominal size, reinforced with MS weld mesh. As the RCC is cast at site, it is imperative to ensure that special care is taken to see that proper curing arrangements are made with adequate supply of water. The contractor shall invariably use mechanical mixer at site for providing RCC protection to ensure consistency of the mix.

For carrying out concreting work in trenches, yellow PVC sheets of width not less than 1.0 M and of weight not less than 1 kg. Per 8 sq. meters shall be spread and nailed on sides of the trench to form trapezoidal section for concreting in the cleaned trench, to avoid seepage of water into the soil.

A bed of cement concrete mixture of appropriate width and 75 mm thickness shall be laid on the PVC sheet, before laying PLB HDPE ducts. The PLB HDPE Ducts shall then be laid above this bed of concrete. After laying the PLB HDPE Ducts, MS weld mesh is wrapped around and tied and concrete mix is poured to form the cross sectional dimensions as instructed by the Engineer-in-charge.

The strength of RCC is dependent on proper curing therefore, it is imperative that water content of RCC mix does not drain out into the surrounding soil. Portions where cement concreting has been carried out shall be cured with sufficient amount of water for reasonable time to harden the surface. After curing, refilling of the balance depth of the trench has to be carried out with excavated soil.

The PLB HDPE Ducts/RCC/GI Pipes shall be laid only in trenches accepted by Engineer-in-Charge or his representative. The Contractor shall exercise due care to ensure that the PLB HDPE Ducts are not subjected to any damage or strain.

Water present in the trench at the time of laying the PLB HDPE Ducts shall be pumped out by the contractor before laying the pipes in the trench to ensure that no mud or water gets into the pipes, thus choking it.

In case of nallahs, which are dry for nine months in a year, the PLB HDPE Ducts shall be laid inside the RCC Pipes laid at a minimum depth of 165 cms, as instructed by the Engineer-in-charge. The mechanical protection shall extend at least 5 meters beyond the bed of nallah on either side.

Notwithstanding anything contained in clauses referred above, the Engineer-in-charge may order, based on special site requirements, that the PLB HDPE Ducts may be encased in reinforced cement concrete, as detailed, ibid. While laying the pipes, a gap of 2 M is kept at convenient locations approx. 200 m apart and at the bends and turns, which will be used as manholes during OF cable pulling. Ends of the PLB HDPE Ducts at the manholes shall be sealed using end caps to avoid choking of the pipes. In a similar manner, manholes shall be kept while approaching bridges, road crossings etc., as instructed by the Engineer-in-charge. The location of the manholes will be decided by the Engineer-in-charge.

7.6.1 Laying Protection Pipes On Bridges And Culverts:

In case trenching and pipe laying is not possible on the culverts, the pipes shall be laid on the surface of the culverts/bridges after due permission from the competent authority. Of late the bridge construction authorities are providing channel ducts on the footpaths on the bridges for various services. The RCC/DWC/ G.I. Pipes can be laid in these ducts for pulling cables. However, for laying cables on existing bridges, where duct arrangement does not exist, one of the following methods may be adopted.

- a. In case of the Bridges/Culverts, where there are no ducts and where the cushion on the top of the Arch is 50 cm to 100 cm or more, G.I. Pipe (Carrying PLB HDPE pipe and cable) may be buried on the top of the Arch adjoining the parapet wall, by digging close to the wheel guards. Every precaution shall be taken to see that no damage occurs to the arch of the culvert. After burying the GI pipe, the excavated surface on the arch shall be restored.
- b. Where the thickness of the Arch is less than 50 cms, the pipe must be buried under the wheel guard masonry and the wheel guard rebuilt.
- c. If neither of the two methods is possible, the G.I. Pipes/GI Troughs must be clamped on the parapet wall with the clamps. If necessary, the pipes may be taken through the parapet wall at the ends where the wall diverges away from the road.

Methods cited in above clauses should be carried out under close supervision of Road authorities.

The surface to be concreted should be thoroughly cleaned and leveled before concreting. At both ends of the Bridges/Culverts, where the GI Pipes /GI Troughs slope down and get buried, the concreting should be extended sufficiently to ensure that no portion of the GI Pipes/GI Troughs is exposed as approved by the Engineer- in- charge to protect the pipe/trough from any possible externally caused damage.

Where white wash/colour wash is existing on the Bridges/ Culverts, the same should also be carried out on the concreted portion to ensure uniformity.

7.7 Back Filling and Dressing of the Trench

Provided that the PLB HDPE pipes have been properly laid in the trench at the specified depth, the back filling operation shall follow as early as practicable. The earth used for filling shall be free from all roots, Grass, shrubs, vegetation, trees, saplings and any other kind of garbage or pebbles. The back filling operation shall be performed in such a manner so as to provide firm support under and above the pipes and to avoid bend or deformation of the PLB HDPE pipes when the pipes get loaded with the back filled earth.

At locations where the back filled materials contains stones/sharp objects which may cause injury to the PLB HDPE pipes and where the excavated or rock fragments are intended to refill the trench in whole or in part, the trench should

be initially filled, with a layer of ordinary soil or loose earth (free from any stones/pebbles) not less than 10 cms thick over the pipes.

Back filling on public, roads, railway crossings, footpaths in city areas shall be performed immediately after laying the HDPE pipes. Back filling at such locations shall be thoroughly rammed, so as to ensure original condition so that it is safe for the road traffic. All excess soil/ material left on road/ footpath/railway crossing shall be removed by contractor. However, along the highways and in country side, the excess dug up material left over after refilling should be kept in a heap above over the trench.

In city limits, at any given time not more than 50 Meters length of trench should be kept open and in all places where excavation has been done, no part of the trench should be kept open over night to avoid occurrence of any mishap or accident in darkness.

7.8 CABLE PULLING AND JOINING/SPLICING

7.8.1 CABLE PULLING

Manholes marked during PLB HDPE Ducts pipe laying of approx size of 2.0 m length x 1.0 m width x 1.65 m depth shall be excavated for pulling the cables. There may be situations where addition manholes are required to be excavated , for some reasons, to facilitate smooth pulling of cable. Excavation of addition manholes will be carried out, without any extra cost. De-watering of the manhole, if required, will be carried out without any extra costs. Dewatering/ De-gasification of the Ducts, if required, will be carried out without any extra costs.

The Optical Fibre cables are available in drums in lengths of approx. 2 kms. The cables shall be blown / manually pulled (in exceptional cases) through already laid PLB HDPE DUCTS. This work is to be carried out under the strict supervision of site in-charge. It shall be ensured that during the blowing / pulling of Cable the tension is minimum and there is no damage to the Cable/Optical fibers.

After pulling of the drum is completed, both ends of the PLB HDPE DUCTS pipe in each Manhole should be sealed by hard rodent resistant rubber bush, to avoid entry of rodents/mud into PLB HDPE Ducts.

The Manholes are prepared by providing 40 mm split PLB HDPE DUCTS pipe of 2.5 to 3m length and closing the split PLB HDPE Ducts by providing necessary clamps/ adhesive tape as per the directions of Engineer-in- charge. Afterwards, the split/cut PLB HDPE DUCTS pipe are covered with 100 mm split RCC pipe of 2m length and sealing the ends of RCC pipe with lean cement solution for protecting bare cable in the manhole . After fixing of RCC Split Pipes necessary back filling/reinstatement and dressing of manholes should be carried out as referred under trenching. The location of the pulling man hole should be recorded for preparation of documentation.

7.8.2 Jointing/ Splicing

Optical Fibre Cable Joints will be at varying distances depending upon the incremental fiber to be laid for connecting Panchayats. The 24 fibers are to be spliced at every Joint & at both ends(Terminations) in the equipment room as

directed by the Engineer-in-charge. The Infrastructure required for cable splicing i.e.

- Splicing machine
- OTDR
- Optical talk set
- Tool kit etc.

will be arranged by the contractor at his own cost and also any additional accessories. e.g. Engine etc. required at site for splicing will also be arranged by the contractor at his own cost.

The Optical Fibre Cable thus jointed end-to-end will be tested for splice losses and transmission parameters as specified by RailTel and prevalent at that time. The through Optical Fibre should meet all the technical parameters, specified and no relaxation will be granted.

7.9 Construction of Jointing Chamber :

The joint chambers are provided at every joint to keep the O.F.C. joint well protected and also to keep extra length of cable, which may be, required to attend the faults at a later date. Jointing chambers are to be prepared at the Fiber Point of Interconnect (FPIO) or normally at distance of every 2 kms. Actual location of jointing chamber depends on length of cable drum and appropriateness of location for carrying out jointing work. The location is finalized by Engineer-in charge.

The jointing chambers are constructed by way of fixing pre-cast RCC chambers/Brick Chambers and covers as per the instructions from Engineer-in-charge.

7.9.1 Pre cast RCC chamber

For fixing of pre-cast RCC chamber, first a pit of size 2 m X 2 m X 1.8 m depth shall be required to be dug. Pre cast RCC chamber shall consist of three parts

- a) Round base plate of 120 cm diameter and 4 cm thickness.
- b) Full round RCC joint chamber with outer diameter of 110 cm and height 50 cm and thickness of 5 cm.
- c) Round top cover of 120 cm diameter and 4 cm thickness in two halves having one handle for each half in center and word "BBNL OFC" engraved on it.

After fixing of pre-cast RCC joint chamber, it should be filled with clean sand before closing. Back filling of joint chamber pit with excavated soil shall be carried out in the end. For detailed specification and diagram refer Fig- 4.1, 4.2 & 4.3

7.9.2 Brick Chamber

For constructing brick chamber, first a pit of size 2m x2 mx1.8 m depth is shall be required to be dug. Then, base of the chamber shall be made using concrete mix of 1:5:10 (1 cement, 5 coarse sand, 10 graded stone aggregate of 40mm nominal size) of size of 1.7m x 1.7 m and 0.15 m thickness. Wall of brick chamber should be constructed on this base having wall thickness of 9" using cement mortar mix of 1:5 (1: cement, 5: fine sand). The chamber should have internal dimensions of 1.2 m x 1.2 m and 1 m height. The bricks to be used for

this purpose should be of size 9" x 4.5" x 3", best quality available and should have smooth rectangular shape with sharp corners and shall be uniform in colour and emit clear ringing sound when struck.

The joint chamber should be so constructed that PLB pipe ends remain protruding minimum 5 cms inside the chamber on completion of plastering. The PLB pipes should be embedded in wall in such a way that, the bottom brick should support the pipe and upper brick should be provided in a manner that PLB HDPE pipe remains free from the weight of the construction. The joint chamber should be plastered on all internal surfaces and top edges with cement mortar of 1:3 (1: cement, 3: coarse sand), 12 mm thick finished with a floating coat of complete cement as per standard. Pre-cast RCC slab with two handles to facilitate easy lifting, of size 0.7 m x 1.4 m and of thickness of 5 cm having one handle for each half in centre and word 'OFC' engraved on it are to be used to cover the joint chamber. Two numbers of such slabs are required for one joint chamber. This pre-cast slab should be made of cement concrete mix of 1:2:4 (1: cement, 2: coarse sand, 4: stone aggregate 6 mm nominal size) reinforced with steel wire fabric 75 x 25 mm mesh of weight not less than 7.75 Kg per sq. Meter. The joint chamber is filled with clean sand before closing. Back filling of joint chamber pit with excavated soil shall be carried out in the end

7.10 Fixing of Route Indicators / Joint Indicators

Pits shall be dug 500 cm to 1000 cm towards jungle side at every Manhole and Jointing chamber for fixing of Route/Joint Indicator. In addition, Route Indicators are also required to be placed where O.F. Cable changes directions like road crossing etc.

The pits for fixing the indicator shall be dug for a size of 60 cms. x 60 cms. and 75 cms (depth).

The indicator shall be secured in upright position by ramming with stone and murrum upto a depth of 60 cms. and concreting in the ratio of 1:2:4 (1: cement, 2: coarse sand, 4 stone aggregate 20 mm nominal size) for the remaining portion of 15 cms. Necessary curing shall be carried out for the concreted structure with sufficient amount of water for reasonable time to harden the structure.

7.10.1 RCC/Pre cast Route Indicators

The route /joint indicator made of pre-cast RCC should have the following dimensions (see Figure '5')

Base - 250 mm x 150 mm

Top - 200 mm x 75 mm

Height - 1250 mm

7.10.2 Stone based Route Indicators

The route /joint indicators made of Sand/lime Stone Should have the following dimension. The word '**BNL OFC**' should be engraved on the Route/Joint indicators.

- i. Stone to be used (Sand/lime Stone)

- ii. Indicator Top surface to be rounded
- iii. Base 155 mm × 100 mm
- iv. Upper 500 mm length to be Tapered width wise as shown in the drawing and homogeneously finished.
- v. Height 650mm (Straight) + 400 mm (Tapered)
- vi. The route indicators should be engraved with word 'OFC' of size 80mm length & 50mm, width.
- vii. Length 3.5 Ft., top 4"x4" dressed 1Ft. from top & tapered.

(See figure '6' for details of Stone Route Indicators)

The Route indicators shall painted Blue and placed at 500 to 1000 cm away from the centre of the trench towards jungle side. The Joint indicators are placed at OFC joints and placed 500 to 1000 cm away from wall of the joint chamber facing jungle side and are painted Grey. The engraved word "BBNL OFC" should be painted in white, on route as well as joint indicators. Numbering of route indicators/joint indicators should also be done in white paint. The numbering scheme for route indicators will be Joint No./Route Indicator No. for that joint. For example, 2/6 marking on a route indicator means 6th route indicator after 2nd joint. Additional joints on account of faults at a later date should be given number of preceding joint with suffix A, B, C, and D. For example sign writing 2A on a joint indicator means, additional joint between joint No. 2 and 3. The numbering of existing route/joint indicator should not be disturbed on account of additional joints. Enamel paints of reputed brand should be used for painting and sign writing of route as well joint indicators.

The route and joint indicator shall be painted with primer before painting with oil paint. The material used should bear ISI mark. The size of each written letter should be at least 3.5 cms. The colours of painting and sign writing is as under :

- (1) For Joint Indicator: Grey colour
- (2) For Route Indicator: Blue colour
- (3) For BBNL OFC & Nos: White colour.

7.11 Documentation

The documentation, consisting of the following shall be prepared for each Block and the Panchayats connected to the Block. 4 sets of documentation shall be provided both in Electronic format on CD as well as Hard binded copy.

For all the newly laid cables, proper route diagrams along with all the relevant details like the alignment and depth of the cable laid, distance from the centre of the road, location of various assets, major landmarks along the cable route are to be recorded in a proper format. This would result in generation of As Built Diagram (ABDs) for the cable routes. Following specifications/instructions are to be followed:

1. The ABDs shall invariable capture the attributes/information as given below

- a) Alignment of the laid cables showing distances from the Centre of the road (offset from Centre of the road) at every 10 meters along with the readings of the depth of the OF cable laid.
 - b) In additions to the above, such readings should invariably be recorded at every turning/bend on the road, road/railway crossing, culverts, diversions etc. at every 5 meters.
 - c) Location of various assets like FPOI/SJC/BJC, Joint Chambers, splitters, FTBs, FDMS route indicators etc. shall be clearly shown. Also the Latitude and Longitude of all the above assets shall also be recorded and provided in the format specified for the same.
 - d) Nearby major landmarks along the cable route and other identifiable fixed indicators like culverts, bridges/nallah, water bodies, crossroads, railway crossing, flyover and public places like temples/mosques, bus-stop, PHC, Post Office, School/College, shops etc. shall be recorded. KM milestones along the cable shall also be marked.
 - e) In cases where additional protection has been provided the details of type protection like GI/DWC/RCC pipe (Half round or full)/RCC/CC etc. should be indicated alongwith their running lengths wherever applicable.
 - f) The location of various telecom nodes falling on the cable laying route like Telephone Exchange, BTS towers shall also be recorded alongwith their Latitude and Longitude.
 - g) The length of the spare OF cable (Coil/Spool) kept at each joint location on either side of the joint should be correctly recorded in meters.
2. The ABDs shall be prepared in two parts. **Part-I** showing the overall cable laying routes for a block or a tree from OLT/FPOI to the ONTs/FTBs which shall identify the various cable laying sections (route length between two nodes) and assets like SJC/BJC, splitters and assign identification numbers to each. **Part-II** shall contain the detailed drawings for the various **Cable Sections (CS)** as depicted/identified in Part-I (Kindly refer the attached sample diagrams).
 3. The ABDs shall be prepared on A4 sheets of 80 GSM paper. Each sheet shall record maximum of about 200 to 250 meters of the route length. **Each sheet in the ABD shall be assigned unique sheet number as prescribed in the attached Annexure-E.**
 4. Separate sheets shall be used for recording details of Cable sections where cables are laid by open trench method, in duct and by HDD method. Kindly see the sample ABD

attached. Separate diagrams (in blown-up details) may be prepared for major road/rail intersections for better clarity of details.

5. The details of various assets shall be provided in a tabular form as specified in the sample ABD attached as Annexure-E.
6. The cover sheet shall be of 110 GSM & laminated.
7. The ABDs shall be submitted both as soft copy and hard copy.

Annexure-E

1. The ABDs can be prepared in any of the formats like Word, Excel or PowerPoint. The legends shown in the attached sample ABDs have been provided in soft form and should be used at the time of preparation of ABDs for the sake of uniformity.
2. The ABD files shall be named as ABD_<block name>.
3. However, in case more than one ABDs are prepared for one block, it is expected that the ABDs would atleast be tree-wise (i.e. full cable route from one FPOI upto its connected GPs). In such cases the soft copy files shall be named as ABD_<block name>_pofq.

Where Block name: is the block name as recorded in Primavera software and
 q : depicts total no. of ABDs for the particular block
 p : depicts the sequence number of the particular ABD

For Example : If for Block XXXXX three ABDs are prepared then the files shall be named as ABD_XXXX_1 of 3, ABD_XXXX_2 of 3 and ABD_XXXX_3 of 3.

4. Each sheet in the ABD shall be suitably numbered as per the following nomenclature scheme.
 - a. First sheet in each ABD shall contain the brief information about the block for which the ABD is prepared and the next two sheets shall contain the legends used in the ABD.
 - b. Part-I sheet shall be numbered as B-<Block Code> /n

Where Block code : is the block code as recorded in Primavera software and
 n : depicts no. of sheets e.g. 1,2,3,4,5.....

For example : For Block NAUBATPUR of district PATNA of BIHAR the sheet Nos. in Part-I shall be assigned as B-2544/1, B-2544/2 and so on.

- c. Part-II sheets shall be numbered as CS-m/n<Block Code>

Where Block code : is the block code as recorded in Primavera software and
 m : depicts Cable section no. as identified in Part-I
 n : depicts no. of sheets e.g. 1,2,3,4,5.....

For example : For Block NAUBATPUR of district PATNA of BIHAR the sheet Nos. in Part-II for cable section-1 (CS-1) shall be assigned as CS-1/1(2544), CS-1/2(2544) and so on depending upon the number of sheets whereas for CS-2 these shall be assigned as CS-2/1(2544), CS-2/2(2544) and so on.



रेलटेल
RAILTEL

A Government of India
Undertaking

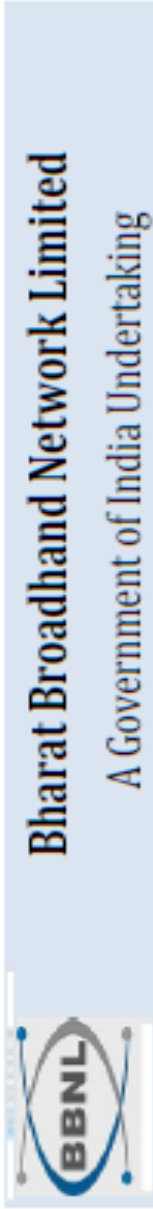

AS BUILT DRAWING (ABD)
FOR INCREMENTAL OF CABLE ROUTE FOR NOFN PROJECT

State : _____
 District : _____
 Block : _____
 Block Code : _____
 LOA No. & Date : _____

















Start Date : _____
 Completion Date : _____
 OF Cable Make & Size : _____

Engineer In-Charge : _____
 Name : _____
 Designation : _____
 Signature : _____

EXECUTING AGENCY
RAILTEL CORPORATION OF INDIA LTD
 Unit : _____
 Contractor Name & Address : _____

**A Government of India
Undertaking**



















LEGEND

ITEMS	SYMBOL
Existing Cable	
Incremental OFC 24F	
Centre of the Road/Lane	
Splitter 1:8 or 1:4 or 1:2	
Gram Panchayat	
Route Indicator	
Branch Joint Closure (BJC)	
Straight Joint Closure (SJC)	
Man Hole	
Railway Lines	
RCC/Brick Joint Chamber	
GI Pipe	
GI Pipe (with CC/RCC/Wire mesh+ CC)	
DWC/RCC Half Round	
DWC/RCC Full Round	
Culvert/Bridge	



A Government of India
Undertaking

Symbols used for Various Landmarks

ITEMS	SYMBOL
Temple/worship Place	
School	
College	
Hospital	
Industry	
Petrol Pump	
Police Station	
Railway Station	
Bus Stand	
Post Office	
Hotel/Dhaba	
Shop	
House/Building	
Electric Transformer/Station	
Boundary Wall	
Electric Pole	
Lamp Pole	
Telephone Pole	



A Government of India
Undertaking

FORMAT:B/1

Sheet: B-XXXX/1

State	
District	
Block	

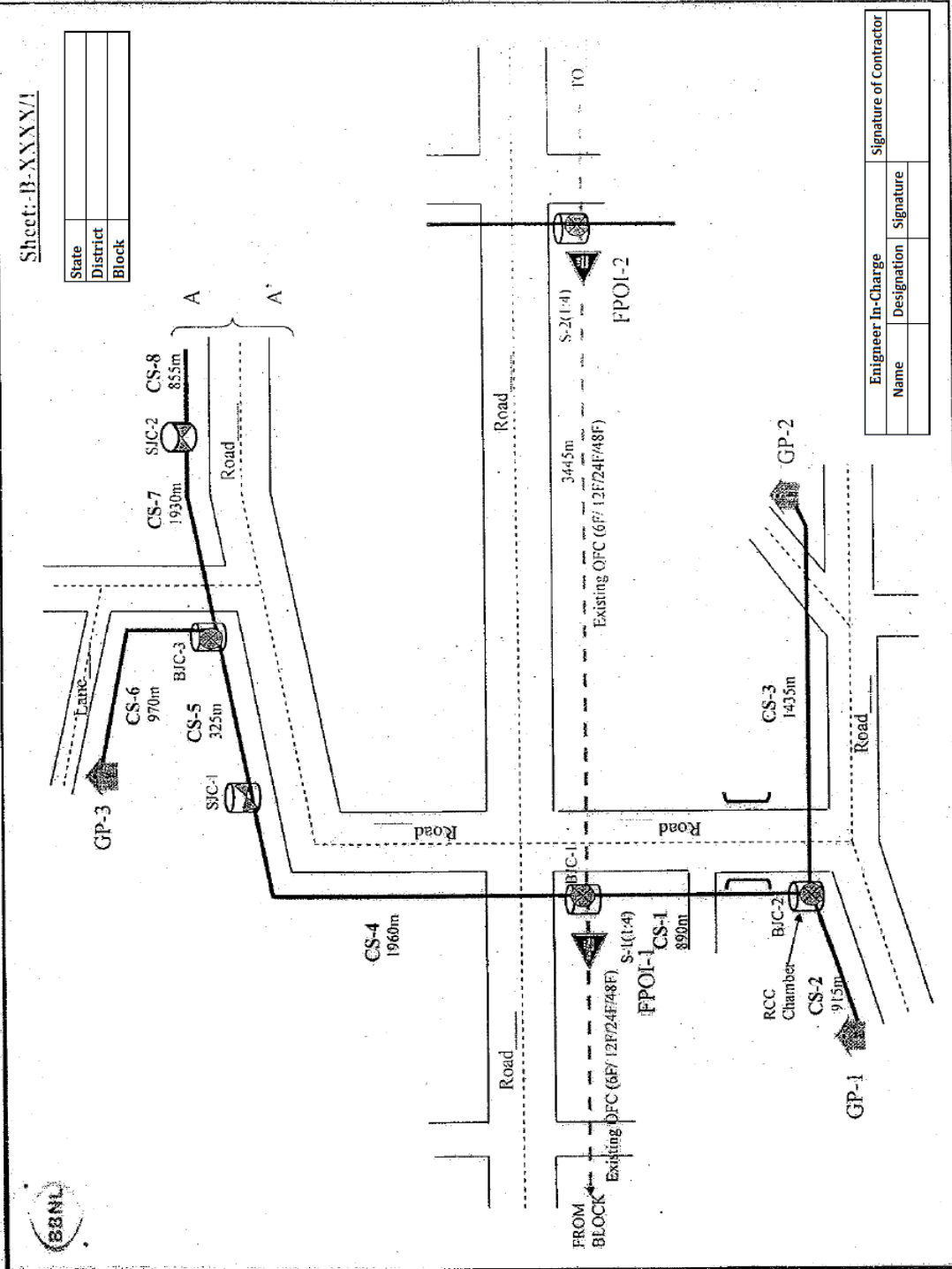

Engineer In-Charge		Signature of Contractor	
Name	Designation	Signature	

Note: Specification/Instruction on Para7.11

A Government of India Undertaking

FORMAT-B/2

Sheet-B-XXXX/2

State	
District	
Block	

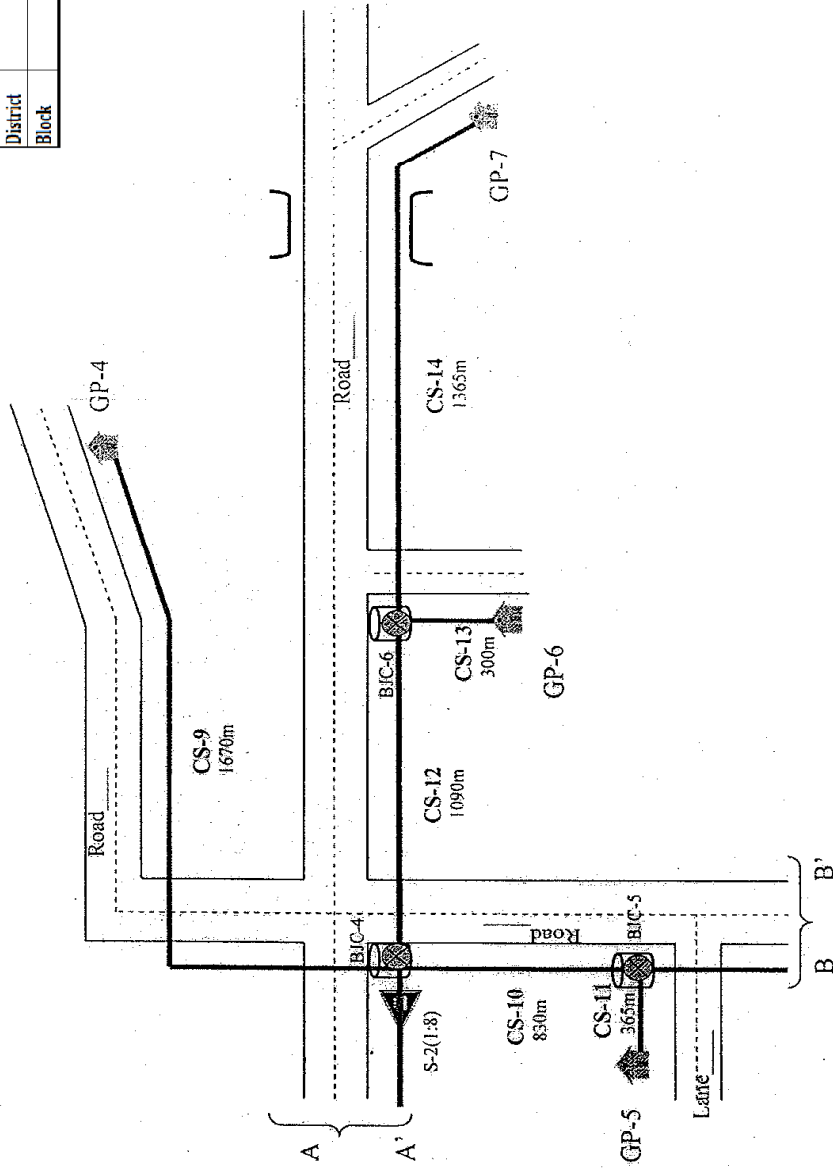

Engineer-in-Charge		Signature of Contractor	
Name	Designation	Signature	



Note: Specification/Instruction on Para 7.11

A Government of India Undertaking

FORMAT:B/3

Sheet:-B-XXXX/3

State	
District	
Block	

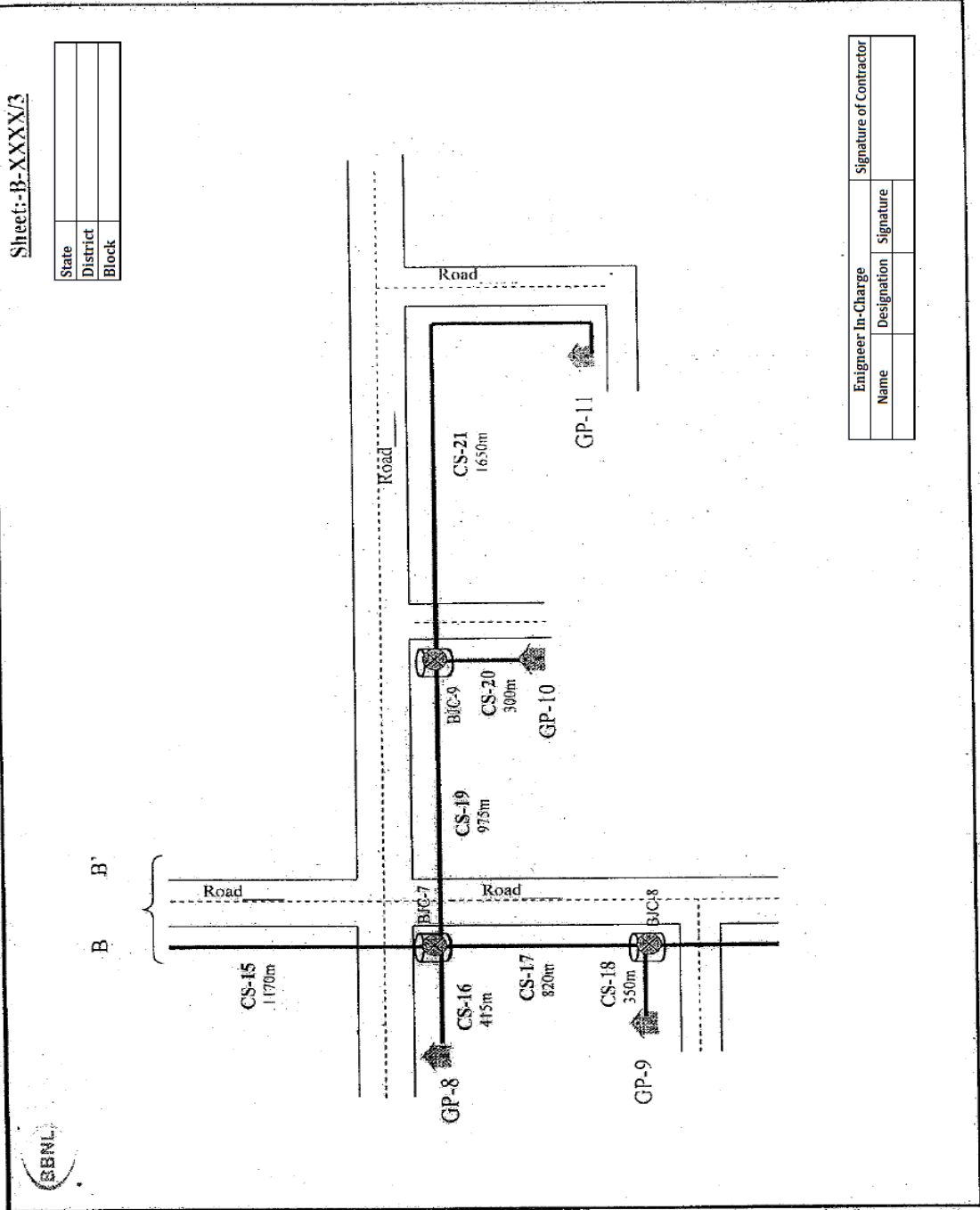

Engineer In-Charge		Signature of Contractor	
Name	Designation	Signature	

Note: Specification/Instruction on Para 7.11

 A Government of India
 Undertaking

FORMAT :B/4

Sheet :B-XXXX/4



Details of the Cable Sections in the Block/Tree

Cable Section No.	Section Details		Excavation Details(in meters)				
	From	To	Route length	Open Trench	HDD	Manual Boring	
CS-1	FPOI-1/S-1(1:4)	B/C-2					
CS-2	B/C-2	GP-1					
CS-3	B/C-2	GP-2					
CS-4	FPOI-1/S-1(1:4)	S/C-1					
CS-5	S/C-1	B/C-3					
CS-6	B/C-3	GP-3					
CS-7	B/C-3	S/C-2					
CS-8	S/C-2	S-2(1:8)					
CS-9	S-2(1:8)	GP-4					
CS-10	S-2(1:8)	B/C-5					
CS-11	B/C-5	GP-5					
CS-12	S-2(1:8)	B/C-5					
CS-13	B/C-6	GP-6					
CS-14	B/C-6	B/C-7					
CS-15	B/C-5	GP-7					
CS-16	B/C-7	GP-8					
CS-17	B/C-7	B/C-8					
CS-18	B/C-8	GP-9					
CS-19	B/C-7	B/C-9					
CS-20	B/C-9	GP-10					
CS-21	B/C-9	GP-11					
Total							

Engineer In-Charge		Signature of Contractor	
Name	Designation	Signature	Signature

Note: Specification/Instruction on Para 7.11

A Government of India
Undertaking

FORMAT :B/5
Sheet :-B-XXXX/5

Location Details of Various Assets

Asset Name	Location	offset from Centre of the Road (meters)	OFC Coil Length (meters)		Latitude	Longitude	Remarks
			Towards GP	Towards OLT/FPOI			
Splitter	S-1 (1-2)						
	S-2 (1-4)						
Br.Joint closure	B/C-1						
	B/C-2						
	B/C-3						
	B/C-4						
	B/C-5						
	B/C-6						
	B/C-7						
	B/C-8						
	B/C-9						
St.Joint Closure	S/C-1						
	S/C-2						
	S/C-3						
Manhole	MH-1						
	MH-2						



Engineer In-Charge		Signature of Contractor	
Name	Designation	Signature	

Note: Specification/Instruction on Para 7.11

Undertaking

FORMAT:CS-1/2

Sheet: CS-1/2(XXXX)
(All dimensions in meters)

Cable Section	CS-1
Sub-section	FROM TO
PLB Laying by	HDD Method

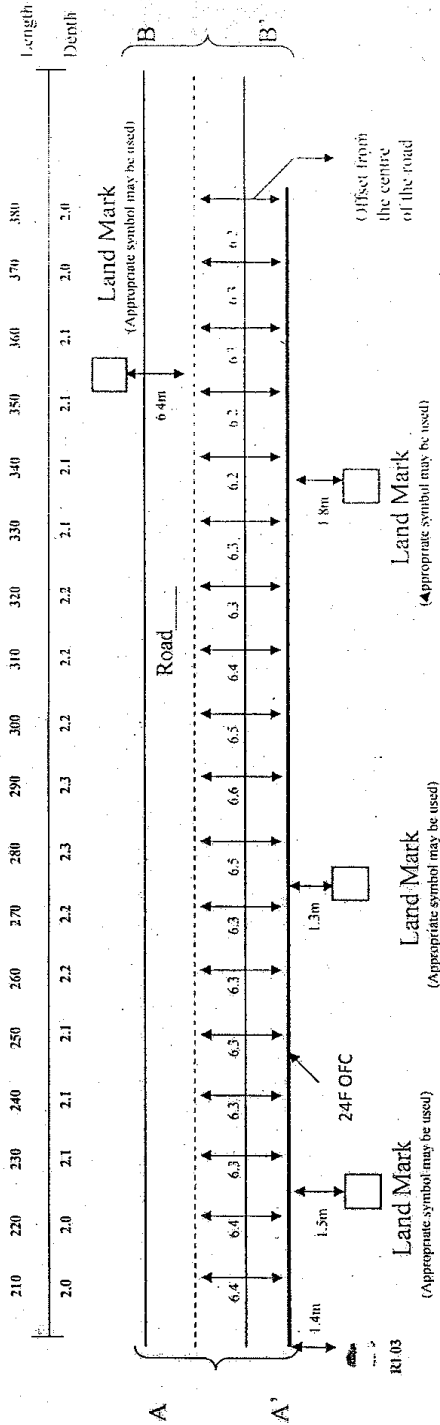

Note: All dimensions are in metre

Engineer-In-Charge	Signature of Contractor
Name	Designation

Note: Specification/Instruction on Para 7.11

Undertaking

FORMAT:CS-1/3

Sheet: CS-1/3(XXXX)

Details of Cable sub-section-work executed through HDD

Cable Section	CS-1	
Sub Section	From	To
Sub Section Length	180m	
Rod No	Distance	Depth
0	0	-1.8
1	3	-1.8
2	6	-2.05
3	9	-2.1
4	12	-2.2
5	15	-2.25
6	18	-2.3
7	21	-2.35
8	24	-2.38
9	27	-2.45
10	30	-2.55
11	33	-2.60
12	36	-2.75
13	39	-2.8
14	42	-2.85
15	45	-2.9
16	48	-3.05
17	51	-3.15
18	54	-3.25
19	57	-3.35
20	60	-3.45
21	63	-3.55
22	66	-3.6
23	69	-3.65
24	72	-3.81
25	75	-3.95
26	78	-3.97
27	81	-3.95
28	84	-3.93
29	87	-3.91
30	90	-3.87
31	93	-3.84
32	96	-3.8
33	99	-3.73
34	102	-3.65
35	105	-3.55
36	108	-3.42
37	111	-3.25
38	114	-2.95
39	117	-2.65
40	120	-2.35
41	123	-2.1
42	126	-1.7
43	129	-1.25
44	132	-0.9
45	135	-0.45
46	138	0
47	141	0.45
48	144	0.9
49	147	1.35
50	150	1.8
51	153	2.25
52	156	2.7
53	159	3.15
54	162	3.6
55	165	4.05
56	168	4.5
57	171	4.95
58	174	5.4
59	177	5.85
60	180	6.3

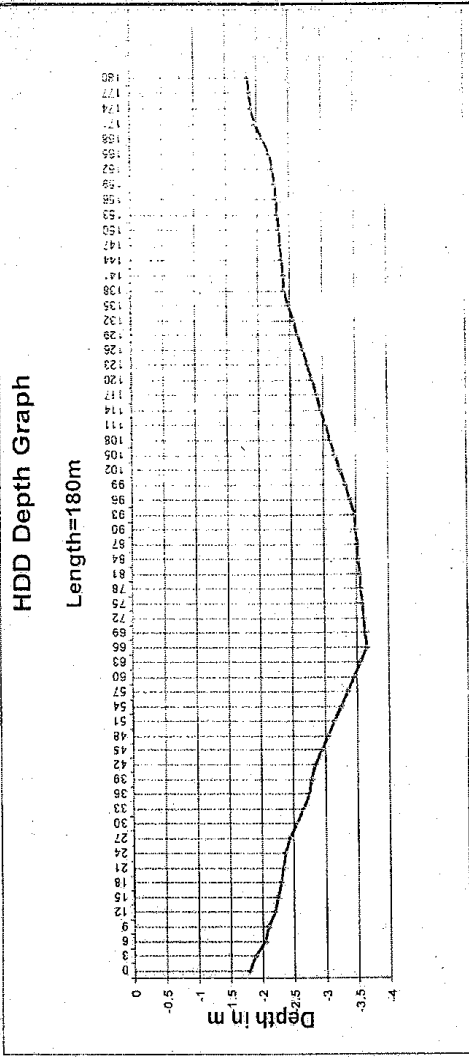

Engineer In-Charge	Signature of Contractor
Name	Designation
	Signature

Note: Specification/Instruction on Para 7.11

Undertaking

FORMAT-CS-1/5

Sheet: CS-1/5(XXXX)
(All dimensions in meters)



Cable Section	CS-1	FROM	TO
Sub-section			
PLB Laying by	Open Trench		

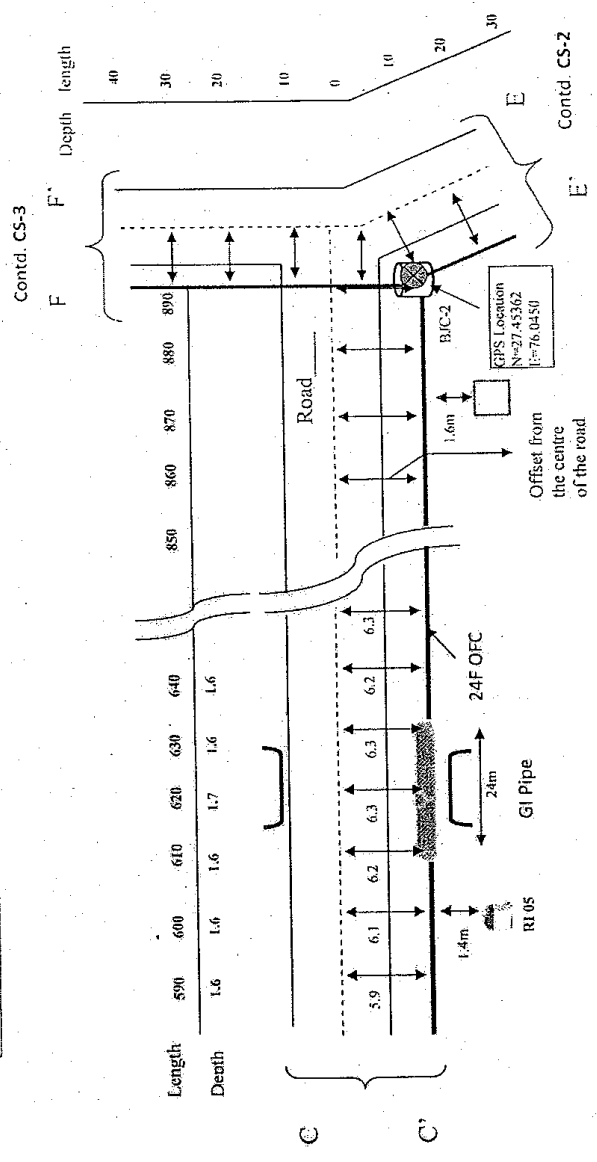

Engineer In-Charge	Signature of Contractor
Name	Designation
Signature	

Note: Specification/Instruction on Para 7.11

7.12 SAFETY PRECAUTIONS

7.12.1 Safety Precautions when excavating or working in excavations close to electric cables

The Engineer- in-charge of the work should get full information from Electricity undertaking regarding any electric cables, which are known or suspected to exist near the proposed excavation and unless this is done, excavation should not be carried out in the section concerned. The electricity undertaking should be asked to send a representative and work should be preceded with close consultation with them.

Only wooden handled hand tools should be used until the electric cables have been completely exposed. Power Cables, not laid in conduits, are usually protected from above by a cover slab of concrete, brick or stone. They may or may not be protected on the sides. It is safer, therefore, always to drive the point of the pickaxe downwards then uncovering a cable, so that there is less chance of missing such warning slabs. No workman should be permitted to work alone where there are electric cables involved. At least one more man should be working near by so that help can be given quickly in case of an accident. If disconnection of power could be arranged in that section it will be better. No electric cables shall be moved or altered without the consent of the Electric Authority and they should be contacted to do the needful. If an electric cable is damaged even slightly, it should be reported to the Electric Authority and any warning bricks disturbed during excavation should be replaced while back filling the trench. Before driving a spike into the ground, the presence of other underground properties should be checked. Information on plans regarding the location of power cables need not to be assumed as wholly accurate. Full precautions should be taken in the vicinity until the power cable is uncovered. All electric cables should be regarded as being live and consequently dangerous. Any power is generally dangerous, even low voltage proving fatal in several cases.

7.12.2 Electric shock-Action and treatment :

Free the victim from the contact as quickly as possible. He should be jerked away from the live conductors by dry timber, dry rope or dry clothing. Care should be taken not to touch with bare hands as his body may be energized while in contact. Artificial respiration should begin immediately to restore breathing even if life appears to be extinct. Every moment of delay is serious, so, in the meanwhile, a doctor should be called for.

7.12.3 Safety Precautions while working in public street and along railway lines :

Where a road or footpath is to be opened up in the course of work, special care should be taken to see that proper protection is provided to prevent any accidents from occurring. Excavation work should be done in such a manner that it will not unduly cause inconvenience to pedestrians or occupants of buildings or obstruct road traffic. Suitable bridges over open trenches should be so planned that these are required for the minimum possible time. Where bridges are constructed to accommodate vehicular traffic and is done near or on railway property, it should be with the full consent and knowledge of the competent railway authorities.

7.12.4 Danger from falling material

Care should be taken to see that apparatus, tools or other excavating implements or excavated materials are not left in a dangerous or insecure position so as to fall or be knocked into the trench thereby injuring any workman who may be working inside the trench.

7.12.5 Care when working in Excavations

Jumping into a trench is dangerous. If it is deep, workmen should be encouraged to lower themselves. Workers should work at safe distance so as to avoid striking each other accidentally with tools. If the walls of the trench contain glass bits, corroded wire or sharp objects they should be removed carefully. If an obstruction is encountered, it should be carefully uncovered and protected if necessary. If an obstruction is encountered, it should be carefully uncovered and protected if necessary. Care must be taken to see that excavated material is not left in such a position that it is likely to cause any accident or obstruction to a roadway or waterway. If possible the excavated material should be put between the workmen and the traffic without encroaching too much on the road.

7.12.6. Danger of cave in

When working in deep trenches in loose soil, timbering up/shoring the sides will prevent soil subsidence. The excavated material should be kept at sufficient distance from the edge of the trench or pit. Vehicles or heavy equipment must not be permitted to approach too close to the excavation.

When making tunneled opening, it should be ensured that the soil is compact enough to prevent cave in even under adverse conditions of traffic. Extra care should be taken while excavating near the foundations of buildings or retaining walls. In such cases, excavation should be done gradually and as far as possible in the presence of the owners of the property.

7.12.7 Protection of Excavations :

Excavations in populated areas, which are not likely to be filled up on the same day should be protected by barriers or other effective means of preventing accidents and the location of all such openings must in any event be indicated by red flags or other suitable warning signs. During the hours from dusk to dawn, adequate number of red warning lamps should be displayed. Supervisory officers should ensure that all excavations are adequately protected in this manner as serious risk and responsibility is involved. Notwithstanding adoption of the above mentioned precautions, works involving excavations should be so arranged as to keep the extent of opened ground and the time to open it to a minimum.

7.12.8 Precautions while working on roads

The period between half an hour after sun-set and half an hour before sunrise, and any period of fog or abnormal darkness may also be considered as night for the purpose of these instructions, for the purpose of providing the warning signs. Excavation liable to cause danger to vehicles or the public must at all times be protected with fencing of rope tied to strong uprights or bamboo poles at a suitable height or by some other effective means. Any such temporary erection which is likely to cause obstructions and which is not readily visible

should be marked by posts carrying red flags or boards with a red background by day and by continuously lighted lamps at night.

The flags and the lamps should be placed in conspicuous positions so as to indicate the pedestrians and drivers of vehicles the full expanse i.e. both width and length of the obstruction. The distance between lamps or between flags should not generally exceed 1.25 m along the width and 6m along length of the obstruction in non congested areas, but 4 meters along the length in congested areas.

If the excavation is extensive, sufficient notice to give adequate warning of the danger, should be displayed conspicuously not less than 1.25 m above the ground and close to the excavation. Where any excavation is not clearly visible for a distance of 25m to traffic approaching from any direction or any part of the carriage way of the road in which the excavation exists, a warning notice should be placed on the kerb or edge of all such roads from which the excavation or as near the distance as is practicable but not less than 10 m from the junction of an entering or intersecting road in which the excavation exists. All warnings, in these should have a red background and should be clearly visible and legible. All warning lamps should exhibit a red light, but white lights may be used in addition to facilitate working at night. Wherever required a passage for pedestrians with foot bridge should be provided. At excavations, cable drums, tools and all materials likely to offer obstructions should be properly folded round and protected. This applies to jointer's tents as well. Leads, hoses etc. stretched and across the carriageway should be guarded adequately for their own protection and also that of the public.

7.12.9 Traffic Control

The police authorities are normally responsible for the control of traffic and may require the setting up of traffic controls to reduce the inconvenience occasioned by establishment of a single line of traffic due to restriction in road width or any other form of obstruction caused by the work. As far as possible, such arrangements should be settled in advance. If there are any specific regulations imposed by the local authorities, these should be followed.

7.12.10 Work along Railway Lines

Normally all works at Railway crossing is to be done under supervision of the railway authorities concerned, but it is to be borne in mind that use of white, red or green flags by the Departmental staff is positively forbidden to be used when working along a railway line as this practice may cause an accident through engine drivers mistaking them for railway signals. When working along a double line of railway, the men should be warned to keep a sharp look on both the "UP" and "DOWN" lines to avoid the possibility of any accident when trains pass or happen to cross one another near the work spot.

7.12.11 Procedure and Safety Precautions for use of explosives during blasting for trenching :

In areas where the cable trench cannot be done manually on account of boulders and rocks, it is necessary to blast the rocks by using suitable explosives. The quality of explosive to be used depends on the nature of the

rocks and the kind of boulders. A few types of explosive fuses and detonators normally used for making trenches for cable works are detailed below:

- i) Gun powder
- ii) Nitrate Mixture
- iii) Gilatine
- iv) Safety fuse
- v) Electric Detonator
- vi) Ordinary Detonator

7.12.11.1 Procedure

A detailed survey of the route is to be done to assess the length of the section where trenching is to be done with the help of blasting. A route diagram of the rocky section may be prepared indicating the length of the route where the explosives are to be used. For the purpose of obtaining license, a longer length of route should be given in the application as in many cases, after digging, rocks appear which was not initially anticipated.

Next a license will have to be obtained for use and storing of explosive in that section. If the area falls under a police commissioner, the authority for granting such license is the police commissioner of the concerned area. When the route does not fall in the jurisdiction of a police commissioner, the authority for issuing license is the District Magistrate.

The concerned authority should be applied in prescribed form with a route map. The concerned authority will make an enquiry and issue license for using/storing explosives for cables trenching work. Such license will be valid for 15 days only. The license should be got renewed if the blasting operation needs to be extended. Once the license is granted, it is the responsibility of the holders of the license for the proper use of explosives, its transportation and storing.

7.12.11.2 Method of using

The safest explosive is the Gilatine and electric detonator. Gilatine is in the form of a stick. Electric detonator is a type of fuse used for firing the explosive electrically. Holes are made at suitable intervals on rocky terrain or boulders either by air compressor or by manual chipping. The depth of the holes should be 2 to 3 ft. Fill up the holes with small quantity of sand for about 6". First the electric detonator is to be inserted into the Gilatine and the Gilatine is to be inserted into the holes keeping the + ve and- ve wirings of electric detonators outside the holes. Again refill the holes with sand. These +ve and-ve insulated wires of detonator are then extended and finally connected to an EXPLODER kept at a distance of not less than 100 m.

Now the explosive is ready for blasting. But, before connecting wires to exploder for blasting, all necessary precautions for stopping the traffic, use of red flags, exchange of caution signals, etc. should be completed and only then Exploder should be connected and operated.

7.12.11.3 Operation of exploder (IDL schaffler type 350 type exploder)

The type 350 blasting machine consists of a bearing block with blasting machine system and the explosion proof light- alloy injection molded housing.

The exploder is held with the left hand. The twist handle is applied to the drive pin, clapped with the right hand turned in the clock wise direction in continuous measurements at the highest speed from the initial position until it reached to a stop. At this stage an indication lamp will glow. When the indication lamp glows, “press button switch” should be pressed. This will extend the electric current to detonator and Gilatine will be detonated. The rock will be blasted out of the trench. Number of holes can be blasted in a single stroke by connecting all such detonators in series connection and finally to the exploder.

After blasting, again mazdoors are engaged on the work to clear the debris. If the result of the first blasting is not satisfactory, it should be repeated again on the same place.

7.12.11.4 Warning

There may be two reasons for unsatisfactory results of the blasting

- a) Misfire of Gilatine due to leakage of current from detonator.
- b) Over loading because of overburdens.

Never pull the broken wire pieces form the holes in such cases. Attempt should not be made to reblast the misfired Gilatine. The safest way is to make a fresh hole by its side and put fresh Gilatinein that hole and blast it.

7.12.11.5 Precautions

The abstract of Explosives Rules 1983 which are relevant to our work is given below :

i. **Restriction of delivery and dispatch of explosives**

No person shall deliver or dispatch any explosives to anyone other than a person who.

- a) is the holder of a license to possess the explosives or the agent of a holder of such a license duly authorized by him in writing on his behalf.

OR

- b) is entitled under these rules to possess the explosives without a license.

The explosives so delivered or dispatched shall in no case exceed the quantity, which the person to whom they are delivered or dispatched is authorized to possess with or without a license under these rules.

No person shall receive explosives form any person other than the holder of a license granted under these rules. No person shall receive from or transfer explosives to any person for a temporary storage or safe custody in a licensed premise unless prior approval is obtained from the Chief Controller.

A person holding license for possession of explosives granted under these rules shall store the explosives only in premised specified in the license.

ii. **Protection from Lightning During Storing**

Every magazine shall have attached there to one or more efficient lightening conductors designed and erected in accordance with the specification laid down in Indian Standard Specifications No.2309 as amended from time to time. The

connections to various parts of earth resistance of the lightning conductor terminal on the building to the earth shall be tested at least once in every year by a qualified electrical engineer or any other competent person holding a certificate of competency in this behalf from the State Electricity Department. A certificate showing the results of such tests and the date of the last test shall be hung up in conspicuous place in the building.

iii. Precautions during thunder-storm

When a thunder- storm appears to be imminent in the vicinity of a magazine or store house every person engaged in or a round such magazine and store house shall be withdrawn to a safe distance from such magazine or store house and the magazine and store house shall be kept closed and locked until the thunder storm has ceased or the threat of it has passed.

iv. Maintenance of records

Every person holding a license granted under these rules for possession, sale or use of explosives shall maintain records in the prescribed form and shall produce such record on demand to an inspection Officer.

v. Explosives not to be kept in damaged boxes

The licensee of every magazine or store house shall ensure that, the explosives are always kept in their original outer package. In case, the outer package gets damaged so that the explosive contained therein cannot be stored or transported, such explosives shall be repacked only after the same are examined by controller of explosives.

vi. Storage of explosives in excess of the licensed quantity

The quantity of any kind of explosives kept in any licensed magazine or store house shall not exceed the quantity entered in the license against such kind of explosives. No explosives in excess of the licensed quantity shall be stored in the magazine or store house unless a permit in this behalf is obtained from the licensing authority by a letter or telegram.

vii. Precautions to be observed at Site

The electric power at the blasting site shall be discontinued as far as practicable before charging the explosives. No work other than that associated with the charging operations shall be carried out within 10 meters of the holes unless otherwise specified to the contrary by the licensing authority.

When charging is completed, any surplus explosive detonators and fuses shall be removed from the vicinity of the hole and stored at a distance which should prevent accidental detonation in the event of a charge detonating prematurely in any hole. The holes which have been charged with explosive shall not be left unattended till the blasting is completed. Care shall be taken to ensure that fuse or wires connected to the detonation are not damaged during the placing of stemming materials and tamping.

viii. Suitable warning procedure to be maintained

The licensee or a person appointed by the licensee to be in charge of the use of explosives at the site shall lay down a clear warning procedure consisting of

warning signs and suitable signals and all persons employed in the area shall be made fully conversant with such signs and signals.

ix. Precautions to be observed while firing

The end of the safety fuse (if used in place of a detonator should be freshly cut before being lighted. The exploders shall be regularly tested and maintained in a fit condition for use in firing. An exploder shall not be used for firing a circuit above its rated capacity. The electric circuits shall be tested for continuity before firing. All persons other than the shot-firer and his assistant, if any, shall be withdrawn from the site before testing the continuity.

For the purpose of jointing, the ends of all wires and cables should have the insulation removed for a maximum length of 5 cms. and should, then be made clear and bright for a minimum length of 2.5 cms. and the ends to be joined should be twisted together so as to have a positive metal contact.

Then these should be taped with insulation to avoid leakage when in contact with earth. In case of blasting with dynamite or any other high explosive, the position of all the bore holes to be drilled shall be marked in circles with white paint. These shall be inspected by the Contractor's agent. Bore holes shall be of a size that the cartridge can easily pass down. After the drilling operation, the agent shall inspect the holes to ensure that drilling has been done only at the marked locations and no extra hole has been drilled. The agent shall then prepare the necessary charge separately for each bore hole. The bore holes shall be thoroughly cleaned before a cartridge is inserted. Only cylindrical wooden tamping rods shall be used for tamping. Metal rods or rod shaving pointed end shall never be used for tamping. One cartridge shall be placed in the bore hole and gently pressed but not rammed down. Other cartridges shall then be added as may be required to make up the necessary charge for the bore hole. The top most cartridge shall be connected to the detonator which shall in turn be connected to the safety fuses of required length. All fuses shall be cut to the length required before being inserted into the holes. Joints in fuses shall be avoided.

Where joints are unavoidable, a semi-circular niche shall be cut in one piece inserted into the niche. The two pieces shall then be wrapped together with string. All joints exposed to dampness shall be wrapped with rubber tape.

The maximum of eight bore holes shall be loaded and fired at one occasion. The charges shall be fired successively and not simultaneously. Immediately before firing, warning shall be given and the agent shall see that all persons have retired to a place of safety. The fuses of the charged holes shall be ignited in the presence of the agent, who shall see that all the fuses are properly ignited.

Careful count shall be kept by the agent and other of each blast as it explodes. In case all the charged bore holes have exploded, the agent shall inspect the site soon after the blast but in case of misfire the agent shall inspect the site after half an hour and mark red crosses (X) over the holes which have not exploded. During this interval of half an hour, nobody shall approach the misfired holes. No driller shall work near such bore until either of the following operations has been done by the agent for the misfired boreholes.

- i. The contractor's agent shall very carefully (when the tamping is a damp clay) extract the tamping with a wooden scraper and withdraw the primer and detonator.
- ii. The holes shall be cleaned for 30 cm of tamping and its direction ascertained by placing a stick in the hole. Another hole shall then be drilled 15 cm away and parallel to it. This hole shall be charged and fired. The misfired holes shall also explode along with the new one.

Before leaving the site of work, the agent of one shift shall inform the another agent relieving him for the next shift, of any case of misfire and each such location shall be jointly inspected and the action to be taken in the matter shall be explained to the relieving agent.

The Engineer-in-charge shall also be informed by the agent of all cases of misfire, their cause and steps taken in that connection.

x. General Precautions

For the safety of persons red flags shall be prominently displayed around the area where blasting operations are to be carried out. All the workers at site, except those who actually ignite the fuse, shall withdraw to a safe distance of at least 200 meters from the blasting site. Audio warning by blowing whistle shall be given before igniting the fuse.

Blasting work shall be done under careful supervision and trained personnel shall be employed. Blasting shall not be done within 200 meters of an existing structure, unless specifically permitted by the Engineer-in-Charge in writing.

xi. Precautions against misfire

The safety fuse shall be cut in an oblique direction with a knife. All saw dust shall be cleared from inside of the detonator. This can be done by blowing down the detonator and tapping the open end. No tools shall be inserted into the detonator for this purpose. If there is water present or if the borehole is damp, the junction of the fuse and detonator shall be made water tight by means of tough grease or any other suitable material. The detonator shall be inserted into the cartridge so that about one-third of the copper tube is left exposed outside the explosive. The safety fuse just above the detonator shall be securely tied in position in the cartridge. Water proof fuse only shall be used in the damp borehole or when water is present in the bore hole. If a misfire has been found to be due to defective fuse, detonator or dynamite, the entire consignment from which the fuse, detonator or dynamite was taken shall be got inspected by the Engineer-in-Charge or his authorized representative before resuming the blasting or returning the consignment.

xii. Precaution against stray currents :

Where electrically operated equipments is used in locations having conductive ground or continuous metal objects, tests shall be made for stray current to ensure that electrical firing can proceed safely.

7.13 ALLIED ACTIVITIES

- 7.13.1 Transportation of Materials :** The materials required for executing the work entrusted to the contractors against a work order shall be made available at Project Store Depot. In some cases the materials may be available at sub divisional store go down. The contractor shall be responsible for transporting the materials, to be supplied by the RailTel or otherwise to execute the work under the contract to site at his/ their own cost. The costs of transportation are subsumed in the standard Schedule Rates and therefore no separate charges are payable on this account.
- 7.13.2 Disposal of Empty Cable Drums :** The contractor shall be responsible to dispose of the empty cable drums after laying of the cables. The cost of various sizes of empty cable drums recoverable from the contractor has been fixed taking into account the prevailing market rates as mentioned in this document.
- 7.13.3** It shall be obligatory on part of the contractor to dispose of the empty cable drums at his/their level and the amount fixed for various empty cable drums shall be recovered from the bill for the work for which the drum (s) was/were issued or from any other amount due to the contractor or the Security Deposit.
- 7.13.4** The contractor shall not be allowed to dump the empty cable drums in Govt./Public place which may cause inconvenience to the RailTel / public
- 7.13.5 Supply Of Materials :** There are some materials required to be supplied by the contractor for execution of work under this contract like Bricks, Cement, Wire Mesh and Steel for protection, etc., besides using other consumables which do/don't become the part of the asset. The contractor shall ensure that the materials supplied are of best quality and workmanship and shall be strictly in accordance with the specifications .
- 7.13.6 Social auditing:** While carrying out the execution work of cable/Eqpt, photography/videography may be carried out on sample basis for duration of 15 to 30 minutes per Gram Panchayat which may also involve the local people of the Gram Panchayats and villages including the Gram Panchayat Pradhan (If possible) and same may be submitted in a form of CD along with the documentation sets for information.

Figure 1

HDPE END CAPS

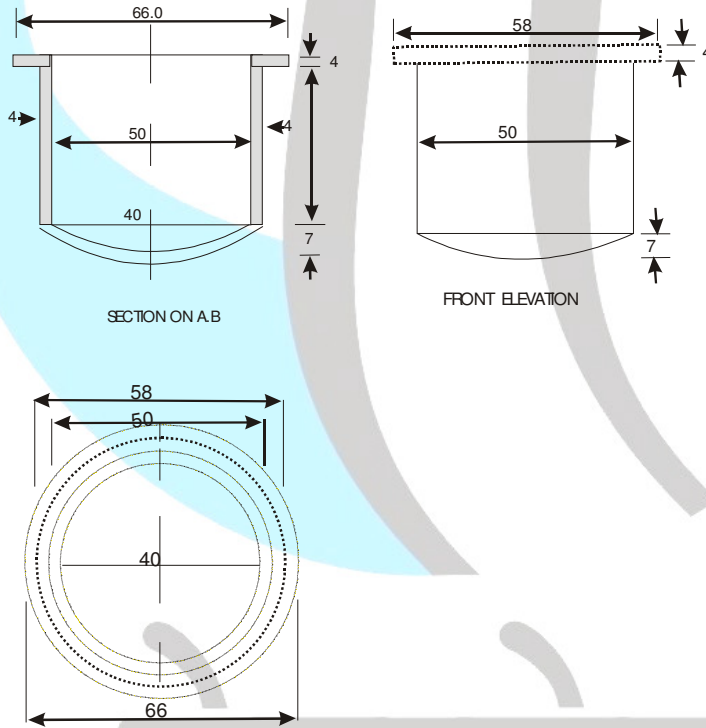

M.S. WELD MESH

Figure2

DETAILS OF 100 MM X 50 MM, 12 SWG MILD STEEL WELD MESH HAVING WIDTH OF 120 CM.

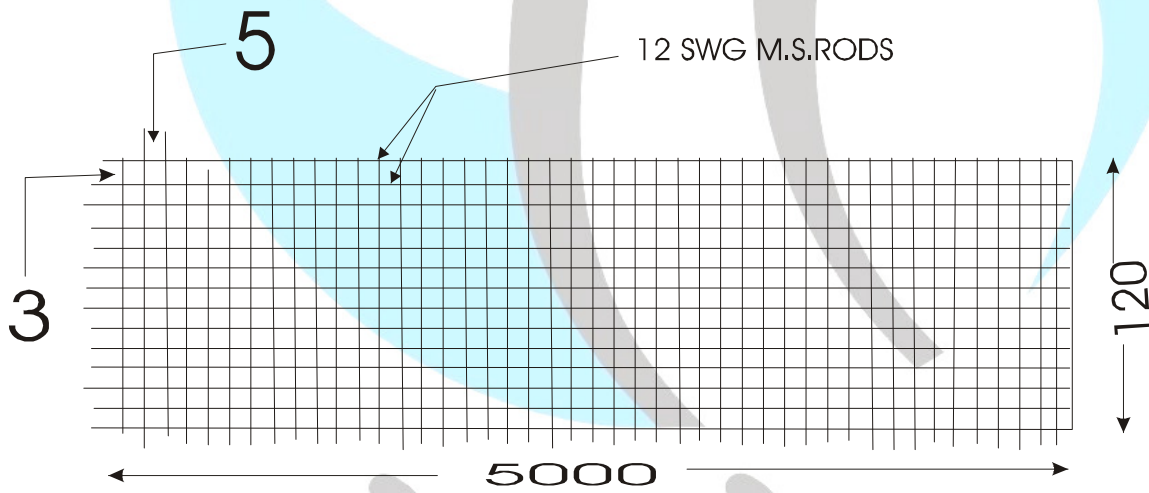

Note : All measurements are in centimeters.

रेलटेल
RAILTEL
A Government of India
Undertaking

Figure 3
Rubber Cork

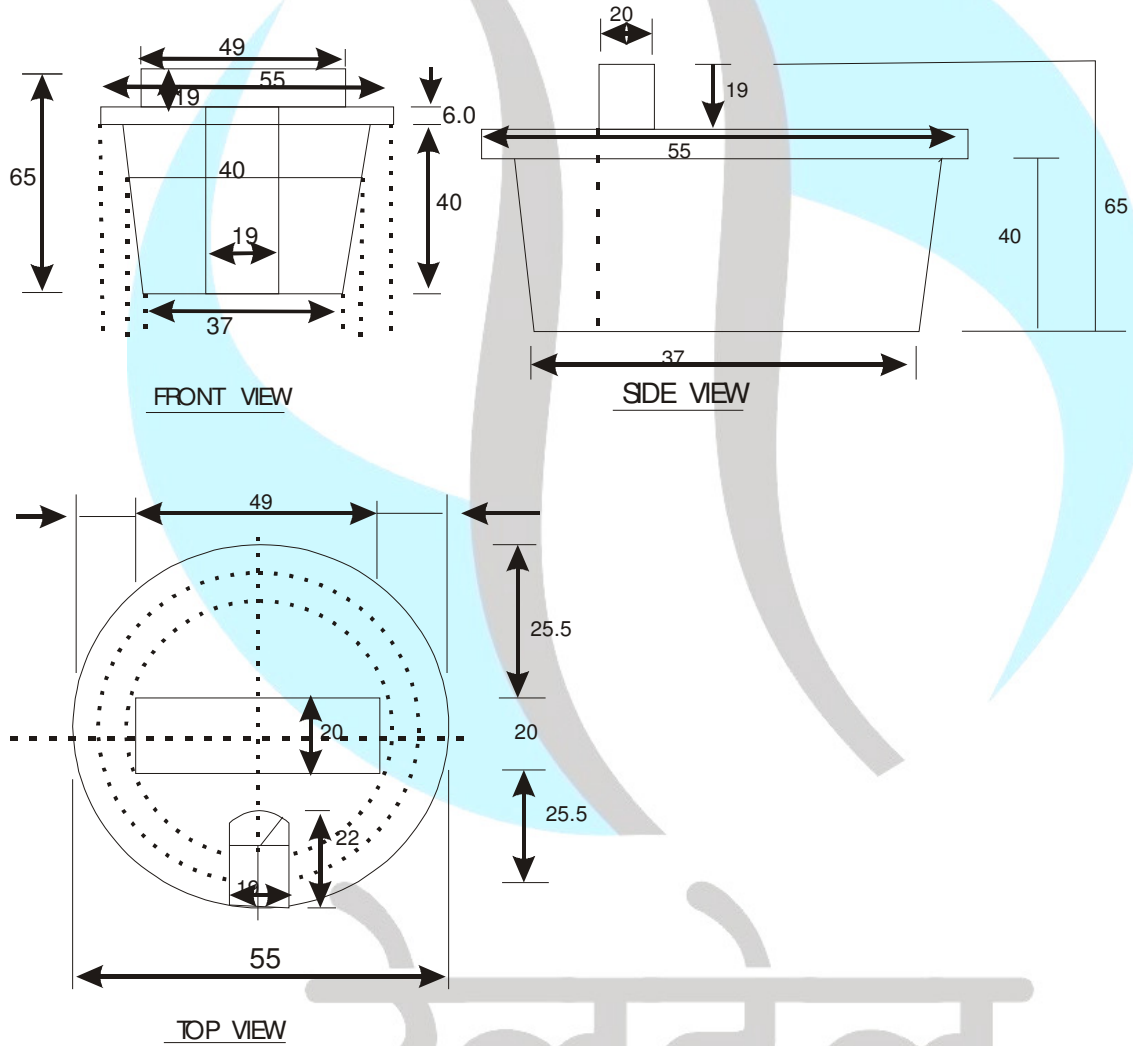

NOTE:

1. ALL DIMENSIONS ARE IN MM.
2. DIMENSIONS ARE ONLY FOR GUIDENCE. TAPPER SHOULD BE SUCH THAT IT SHOULD TIGHTLY FIX. INTO TYPE A & TYPE B HOPE 50 mm OO PIPES.

RAILTEL
A Government of India
Undertaking

Figure 4.1

TECHNICAL SPECIFICATION AND REINFORMENT DETAILS OF PRECAST RCC CHMEBER-RINGS/COLLER

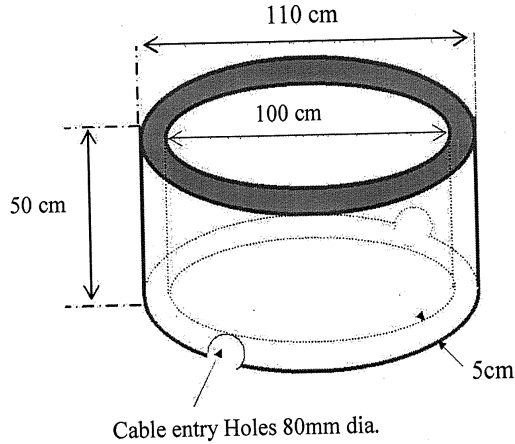

Specification :

1. Inner diameter : 100 cm
2. Outer diameter: 110 cm
3. Height : 50 cm (2 rings of 25 cm each or 1 ring of 50 cm)
4. Thickness : 5 cm
5. Two number of 80mm diameter semicircular holes for cable entry diametrically opposite to each other at bottom end of the collar.
6. RCC Rings shall be NP-2 Class. The ring may be supplied either as two rings of 25 cm each or as one of 50 cm. One single ring shall be preferably

REINFORCEMENT DETAILS

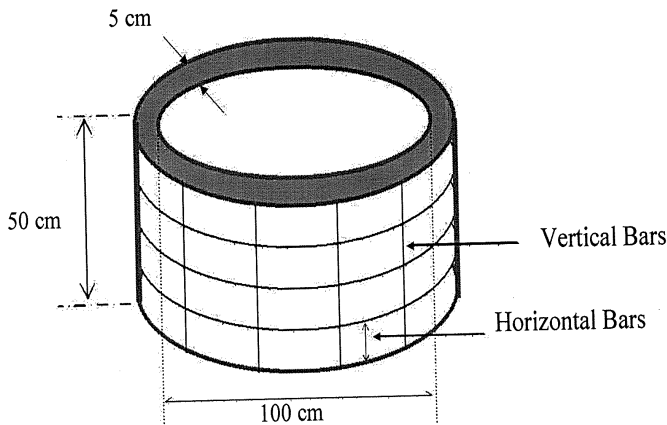

Reinforcement details

1. 6mm Horizontal Iron round rings -4 nos
2. 6mm Verticals bars -12 nos
3. 12 Gauge GI wire mesh to be rapped before reinforcing the concrete.
4. Concrete Mix: 1:2:3 (1 cement: 2 sand: 3 graded stone aggregate 20 mm nominal size)
5. Finishing: smooth

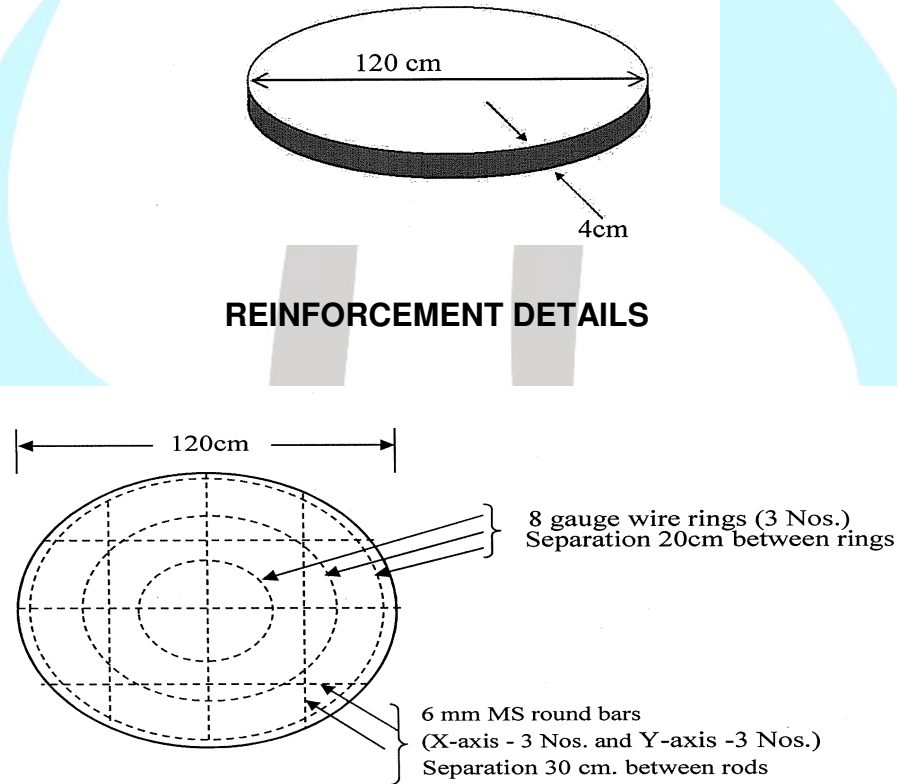
Figure 4.2**TECHNICAL SPECIFICATION AND REINFORCEMENT DETAILS PRECAST RCC CHAMBER-ROUND BASE PLATE****Specification and Reinforcement Details**

1. 120 cm outer diameter circular plate with 4 cm thickness.
2. 8 gauge wire rings-3 Nos. at equidistance.
3. The separation of 6mm MS round rings shall be about 20cm between the rings.
4. 6 mm MS round bars on X axis -3 nos and on Y axis -3 Nos.
5. 6 mm MS round bars separation shall be about 30 cm.
6. Concrete Mix-1:2:3 (1 cement: 2 Sand : 3 graded stone aggregate 20 mm nominal size)
7. Finishing: smooth
8. The base plate can be supplied in two halves also. However in such cases 6 mm MS round bars shall be X axis and 2 Nos. on Y axis.

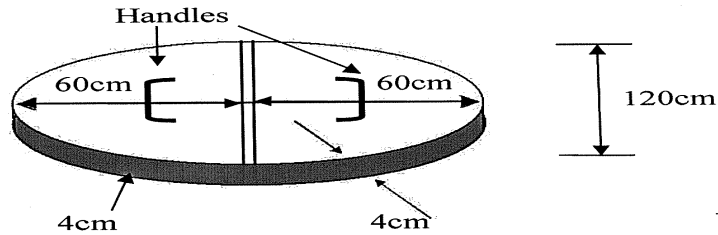
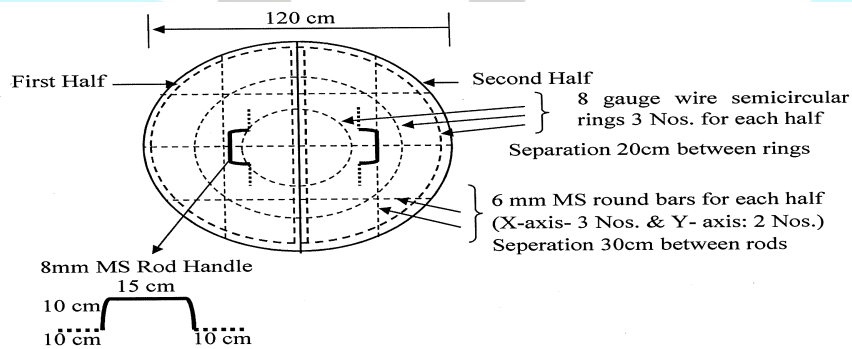
Figure 4.3**TECHNICAL SPECIFICATION AND REINFORCEMENT DETAILS OF PRECAST
RCC CHEMBER-ROUND TOP COVER****REINFORCEMENT DETAILS****Specification and Reinforcement Details**

1. Two numbers of semicircular plates of 120 cm diameter(60 cm radius)
2. 8 gauge wire semicircular rings 3 Nos. for each half. Separation between the rings shall 20 cm.
3. 6 mm MS round bars X-axis : 3 Nos. and Y- axis : 2 Nos. for each half .Separation between the bars shall be 30 cm.
4. One handle shall be provided for each half in center for handling and for smooth opening of joint chamber. The hooks size shall be size of 15 cm x 10cm of 8 mm MS rod and properly secured with reinforcement.
5. The word "BBNL OFC" shall be engraved on each half.
6. Concrete Mix: 1:2:3 (1 cement: 2 sand: 3 graded stone aggregate 20 mm nominal size)
7. Finishing: smooth

Figure 5

RCC Route Indicator

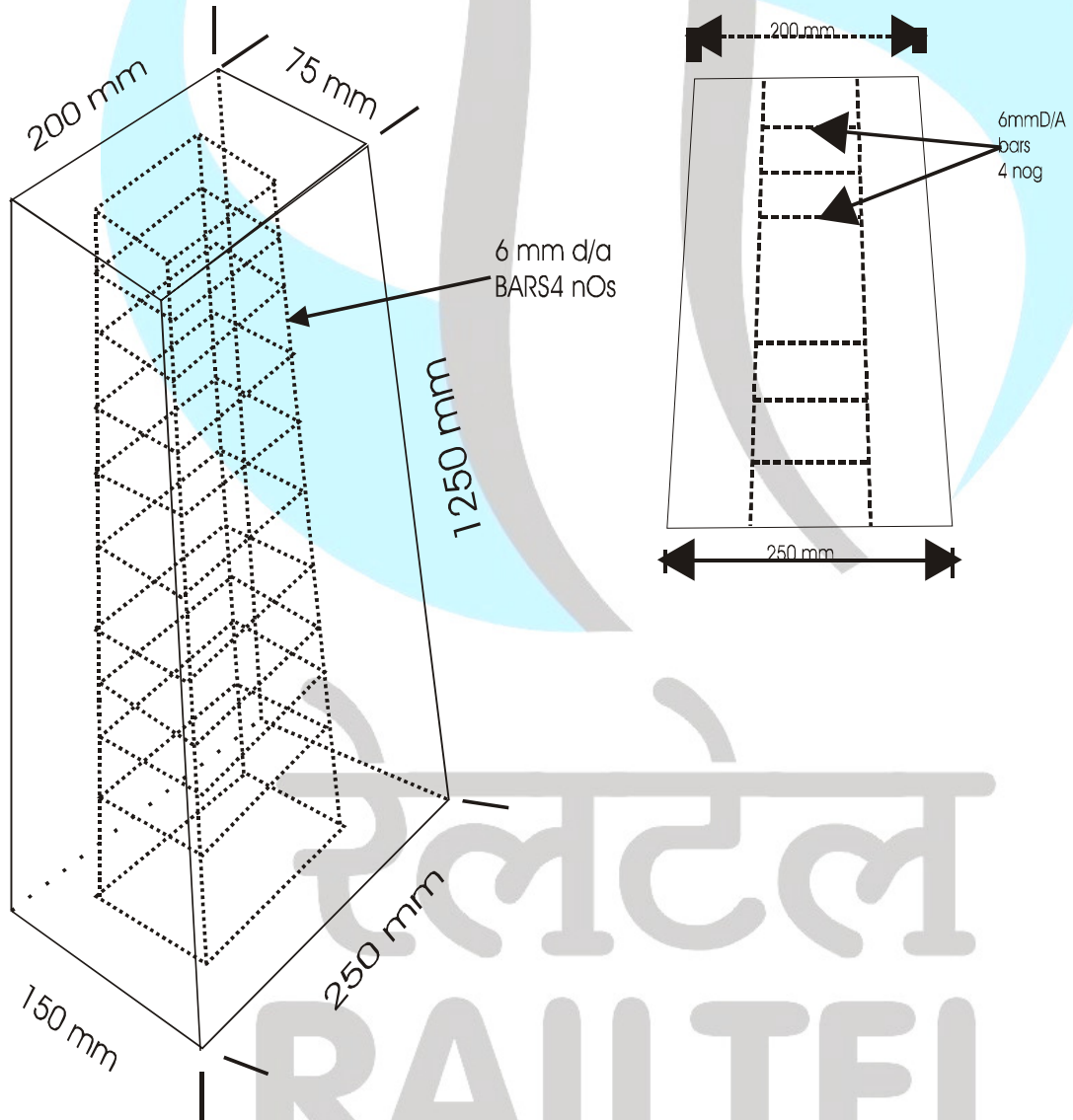

रेलटेल
RAILTEL
A Government of India
Undertaking

Figure 6

1. Stone OFC Route Indicator

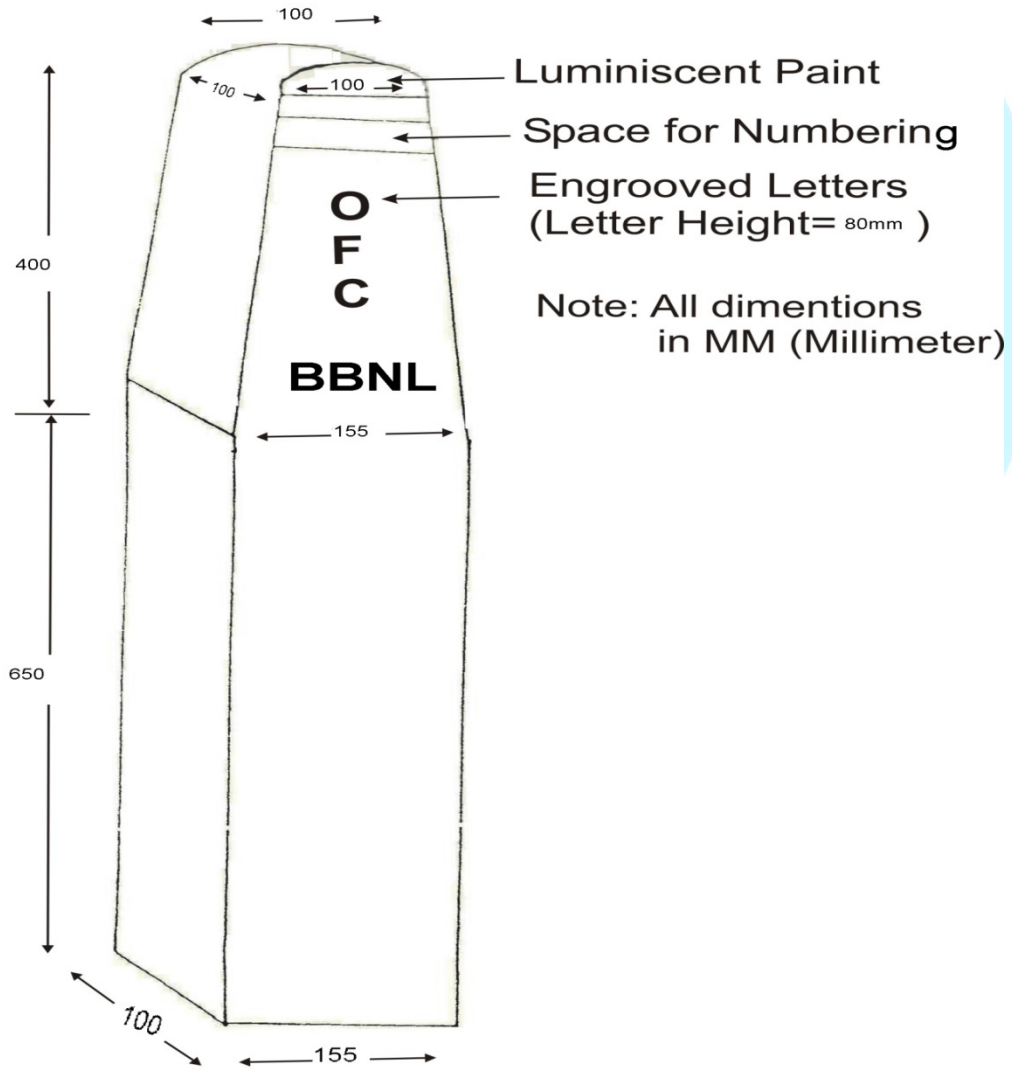

RAILTEL
A Government of India
Undertaking

7.14 TECHNIQUE FOR JOINTING OF OPTICAL FIBER CABLE

Fusion splicing shall be used for splicing fibers. This is accomplished by applying localized heating (i.e. by electric arc or flame) at the interface between two butted, pre-aligned fiber ends, causing them to soften and fuse together.

7.14.1 STRAIGHT JOINT FOR FIBER OPTIC CABLE

There are various types of joint enclosures available in the market. The procedure for assembly of joint closure is described in the installation manual supplied with straight joint closure. This includes the following:

- a) Material inside joint closure kit
- b) Installation tools required
- c) Detailed procedure for cable jointing
- d) Procedure for re-opening the closure.

The Optic Fiber straight through joint closure shall be as per specn. TEC TO 910 G92 (latest) or a proven design approved by RCIL. The joint shall be protected in brick chamber as however, generally, the following steps are involved for jointing of the cable:

- Preparation of cable for jointing
- Stripping/cutting the cable
- Preparation of Cable and joint closure for splicing
- Stripping and Cleaving of Fibers
- Fiber splicing
- Organizing fibers and Finishing joints
- Sealing of joint closure and
- Placing joint in pit

7.14.2 PREPARATION OF CABLE FOR JOINTING

- a) During the installation, a minimum of 10 meter of cable of each end is coiled in the jointing pit to provide for jointing to be carried out at convenient location as well as spare length to be available for future use in case of failures.
- b) The pit size must be chosen carefully to ensure that length of the wall on which joint is mounted is greater than closure length plus twice the minimum bending radius of the cable. A pit length of 1 meter is sufficient for most of the cable and joint closures. Bracket to support the cable coil are also fixed on the wall of the pit.
- c) The cable is then coiled on to the pit wall in the same position as required after the joint is complete. The marking is done on all the loops so that it will be easier to install it later.

- d) The distance from the last centre to the end of the cable must be at least 1.8 meter. This is being the minimum to be stripped for Preparation of joint.
- e) Sufficient cable at each end up to the jointing vehicle/enclosure is then uncoiled from the pit for jointing.

7.14.3 STRIPPING/CUTTING OF THE CABLE

- a) The cables are stripped of their outer and inner sheath with each sheath staggered approximately 10mm from the one above it.
- b) Proper care must be taken when removing the inner sheath to ensure the fibers are not scratched or cut with the stripping knife or tool. To prevent this, it is best to only score the inner sheath twice on opposite sides of the cable, rather than cut completely through it. The two scores marking on either side of the cable are then stripped of the inner sheath by hand quite easily.
- c) The fibers are then removed from cable one by one and each fiber is cleaned individually using Kerosene to remove the jelly.

7.14.4 PREPARATION OF CABLE JOINT CLOSURE FOR SPLICING

The type of Preparation work performed on the cable prior to splicing differs on the type of joint closure and fiber organizer used. However, the following steps are usually common: -

- a) The strength members of each cable are joined to each other and/or to the central frame of the joint closure.
- b) The joint closure is assembled around the cable.
- c) The sealing compound or heat shrink sleeve is applied to the cables and closure, or prepared for application after splicing is complete
- d) The fibers are protected (usually with plastic tubing) in their run from the cable core to the fiber organizer trays (particularly if cable construction is slotted core type).
- e) Tags, which identify the fibers no. are attached at suitable location on the fibers.
- f) Splice protectors are slipped over each fiber in readiness for placing over the bare fiber after splicing.

7.14.5 STRIPPING AND CLEAVING OF FIBER

- a) Prior to splicing each fiber must have approximately 50mm of its primary protective U.V. cured coating removed, using fiber stripper which are manufactured to fine tolerances and only score the coating without contacting the glass fiber.
- b) The bare fiber is then wiped with a lint free tissue doused with ethyl alcohol.
- c) Cleaving of the fiber is then performed to obtain as close as possible to a perfect 90 degree face on the fiber.

7.14.6 SPLICING OF THE FIBERS

The fusion splicing shall be used for fiber splicing.

7.14.7 FUSION SPLICING OF FIBER

Some of the general steps with full automatic microprocessor control splicing machine are as under:

- a) Wash hands thoroughly prior to commencing this procedure.
- b) Dip the clean bare fiber in the beaker of ethyl alcohol of the ultrasonic cleaver. Switch on ultrasonic cleaver for 5-10 seconds (Some of the manufacturers do not prescribe the above cleaning).
- c) Place the bare fiber inside 'V' groove of the splicing machine by opening clamp handle such that the end of fiber is app. 1 mm. over the end of the "V" groove towards the electrodes.
- d) Repeat the same procedure for other fiber, however, first insert heat shrink splice protector.
- e) Press the start button on the splice controller.
- f) The machine will pre fuse, set align both in 'X' and 'Y' direction and than finally fuse the fiber.
- g) Inspect the splice on monitor if provided on the fusion splicing machine and assure no nicking, bulging is there and cores appear to be adequately aligned. If the splice does not visually look good repeat the above procedure.
- h) Slide the heat shrink protector over the splice and place in tube heater. Heat is complete when soft inner layer is seen to be 'oozing' out of the ends of the outer layer of the protector.
- i) Repeat for other fibers.

7.14.8 FUSION SPLICER AND OTDR

The fusion splicer and Optical Time Domain Reflectometer (OTDR), to be used for splicing and measurements of Parameters respectively, shall be of approved design and quality. The contractor shall submit

- i) Specification of fusion splicer and OTDR.
- ii) Certificate from the users, who have used the splicer and OTDR of the make, the contractor intends to use, regarding their satisfactory performance.

The RCIL reserves the right to direct the contractor to use the same or any other proven design of fusion splicer and OTDR if in the opinion of RCIL the specification of Fusion splicer and OTDR are not suitable.

7.14.9 ORGANIZING FIBER AND FINISHING JOINTS

- a) After each fiber is spliced, the heat shrink protection sleeve must be slipped over the bare fiber before any handling of fiber takes place, as uncoated fibers are very brittle and cannot withstand small radius bends without breaking.
- b) The fiber is then organized into its tray by coiling the fibers on each side of the protection sleeve using the full tray side to ensure the maximum radius possible for fiber coils.
- c) The tray is placed in the position.
- d) OTDR reading taken for all splices in this organized state and recorded on the test sheet to confirm that all fibers attenuation are within specification. This OTDR test confirms fibers were not subjected to excessive stress during the organizing process.
- e) After this the joint can be closed with necessary sealing etc. and ready for placement in the pit.

7.14.10 PLACING OF COMPLETED JOINT IN PIT

- a) Joint is to be placed on the tarpaulin provided near the pit.
- b) The cable is laid on the ground, loop the cable such that pen mark previously place on the cable line up. Tape these loops together at the top of the coil.
- c) The joint can now be permanently closed and sealed by heating heat shrinkable sleeve etc. However, before closing, silica gel to be kept inside for moisture protection.
- d) Now the joint closure is fixed to the bracket on the pit wall and pit is closed.

7.14.11 RE-OPENING OF THE JOINT

If required for attending to faults etc., manufacturers supply special kits for opening of the joint and the steps to be followed. However, the general steps are as under : -

- a) Using suitable knife cut heat shrink sleeve longitudinally along its entire length.
- b) Do not damage the smaller heat shrunk sleeve on the ends of the joint.
- c) Apply heat to the cut sleeve until it begins to separate.
- d) Gently remove the cut sleeve from the joint. Now the joint can be opened.
- e) Protective sleeve/cover can be removed for attending to faults etc.

7.14.12 TERMINATION JOINT FOR FIBER OPTIC CABLE.

7.14.12.1 This joint is provided in the cable hut for terminating the outdoor fiber optic cable of both the sides, splicing through fibers, connecting fibers to pigtails for connection to optical line terminal equipment etc.

The OFC Cables shall be dressed up on teak wood plank/Aluminium ladder inside cable hut. The armour of the OFC Cable shall be cut before taking the cable in the equipment rack. The cables shall be terminated on OFC termination joint closures.

The joint enclosure shall be mounted suitably inside the equipment rack. Two pairs of fibers shall be derived from either side cable at every OFC cable hut through pigtails with FC/PC connectors. The remaining fibers shall be looped through.

7.14.12.2 The procedure for installation of termination joint box depends upon the type of joint enclosure. The installation manual supplied gives the step-by-step procedure for installation. However, the general steps are as under: -

- Marking the cable
- Stripping/cutting the cable
- Gripping cable in sheath/clamp
- Treatment of tension member
- Fiber splicing
- Enclosing fiber
- Fixing strength member
- Closing the cover
- Fixing termination box
- Fixing the cable.

7.14.12.3 MARKING THE CABLE

- a) Determine the cable length up to the proposed location of termination box. It is also to be ensured that at least 10 meters of cable is coiled in the cable pit.
- b) Determine the cutting point and mark the cable
- c) Determine the sheath peeling point and mark the cable

7.14.12.4 CUTTING / STRIPPING THE CABLE

- a) Cut the cable as per the marking
- b) Remove the sheath from cable ends. During sheath stripping care should be taken not to damage the fibers.
- c) The length and the steps for various sheath cutting shall be as per the instruction given in the manual.

7.14.12.5 GRIPPING THE CABLE

- a) Wind PVC tape around the cable core just beside edge of the sheath.
- b) Insert the bushing inside sheath by cutting the cable sheath for about 25 mm.
- c) Place the sheath grip (lower half and upper half) and tighten it with the help of torque wrench.

7.14.12.6 FIXING OF TENSION MEMBER

- a) Mark the tension member for the specified length and cut it.
- b) Clean the tension member thoroughly by Alcohol and cotton cloth.
- c) Fix tension member holder with the help of instant adhesive at the end of tension member.

7.14.12.7 FIBER SPLICING

The procedure for splicing is same as described for straight joint closure

7.14.12.8 ENCLOSING FIBERS

- a) Set the fiber cassette on the base.
- b) Arrange excess length of fiber to make double figure of eight.
- c) Enclose the spliced fiber and its excess length carefully.
- d) Repeat the procedure for other fibers.

- e) After this, the box can be closed. However, a packet of silica gel may be placed inside for protection from entry of moisture.

7.14.12.9 MOUNTING OF TERMINATION BOX.

Termination box can be fixed either on wall or on equipment rack. At wayside stations it shall be mounted inside the equipment rack in order to prevent pigtailed from rodent attacks.

- a) Mark the fixing holes on the walls/bracket/frame
- b) Place the termination box and tightened the nuts inside the base box.
- c) Put the covers.

7.14.12.10 FIXING THE CABLE

Secure the cable on wall/frame at two places within one meter from termination box keeping in view straight entry of cable in termination box.

7.15 TOOLS AND EQUIPMENTS REQUIRED FOR JOINTING AND TERMINATION OF FIBER OPTIC CABLE.

S. No. Tool's Name

1. Branch Joint Closure
2. Termination Box
3. Rubber end Block
4. Sheath Clamp
5. Bushing
6. Strength Member holder
7. Heat Shrinkage tube
8. Arc fusion splicer machine.
9. Power cord AC/DC
10. Walkie-Talkie 12V DC source
11. Tube heater
12. Precision cleaver
13. Cable sheath stripper
14. Fiber stripper
15. Knife for HDPE cutting
16. Hexa for strength membrane
17. Isopropyl alcohol or methanol of high specific gravity
18. Johnson Buds
19. Tweezers
20. Gun heater Blower type
21. Sleeve for splice protection
22. O.T. D.R.
23. Stickers for numbering of splicers
24. Portable k. oil generator
25. Umbrella's 2 Nos.
26. Dust protection for splicing machine.

A Government of India

Note: Wherever cable has to be coiled/ looped, the diameter of the coil/loop shall be greater than 30 times the diameter of the cable.

7.16 Supplementary Engineering Instructions to BBNL Engineering Instructions

In general, Engineering Instructions issued by BBNL shall be followed which is enclosed herewith. However some special instructions are given below which are to be followed by the contractor while executing the work and it will superimpose the engineering instructions of BBNL in case of conflict.

1. Competent authority shall be the Engineer-In-charge.
2. Generally DWC pipe shall be used for protection of HDPE Duct, wherever RCC pipe is indicated in Engineering Instructions.
3. Minimum depth of 60cms in Rocky soil shall be achieved and protection of DWC pipe shall be provided with a layer of sand and concreting as per drawing enclosed.
4. For hard rock where surface cutting is not possible, GI pipe shall be used duly protected by clamps(5 mm x 50 mm) or concreting as per instructions of Engineer-Incharge.
5. HDD/Boring shall be used for crossing Road, Railway line or other similar facilities. However, wherein open excavation is adopted, road restoration work shall be done with bituminous macadam for semi grouting 50 mm thick and premix carpet surfacing 25 mm thick over the grouted surface (total upto 75 mm thick), including supply of asphalt etc. to evenly match the road, including consolidation and rolling as per standard specification of DSR 1997 or with cement concrete 1:4:8 mix for thickness varying from 150 mm to 225 mm, to evenly match the road.
6. The HDPE Duct shall be supplied in approx length of 1 KM, Optical Fiber Cable shall be blown using blowing machine and compressor. Where it is difficult to blow the cable, manual pulling of the cable using proper tools and accessories can be considered by Engineer-In-charge.
7. Manhole shall be made wherever necessary to facilitate blowing/pulling of OFC, at culverts/bridges/nallahs, road/rail crossing and near to Gram Panchayat for OFC loop.
8. HDPE pipe shall be coupled by the coupler at manholes made for blowing of OFC and sealing of both ends of the HDPE pipe shall be done by hard rubber bush of suitable size at manholes where OFC loop/ joint is kept.
9. Joint/route indicators shall be installed at approx every 200 mtr/manhole/diversion/jointing chamber etc.
10. GI pipe used shall be perforated.
11. PVC flexible conduit pipe shall be used in corridor/risers/exch premises (leading in work) and should be ISI, medium duty class of standard make having inner diameter of 40 mm.
12. In case of lesser depth, the payment shall be done as per below :-

For Kachcha & pucca soil

- i. <165 cms to \geq 120 cms depth = 30% reduction of approved rate.
- ii. <120 cms to \geq 90 cms depth= 50% reduction of approved rate.

- iii. No payment shall be made for trenching less than 90 cms depth.
13. Suggested Drawings for protection work are enclosed. These are only indicative and parameters brought out in however engineering instructions shall be followed. Drawing numbers are given below:-
- i. No. RCIL/ER/DRG-05/06
 - ii. No. RCIL/ER/DRG-08A/06
 - iii. No. RCIL/ER/DRG-08B/06
 - iv. No. RCIL/WR/DRG-01/13
 - v. No. RCIL/WR/DRG-03/13



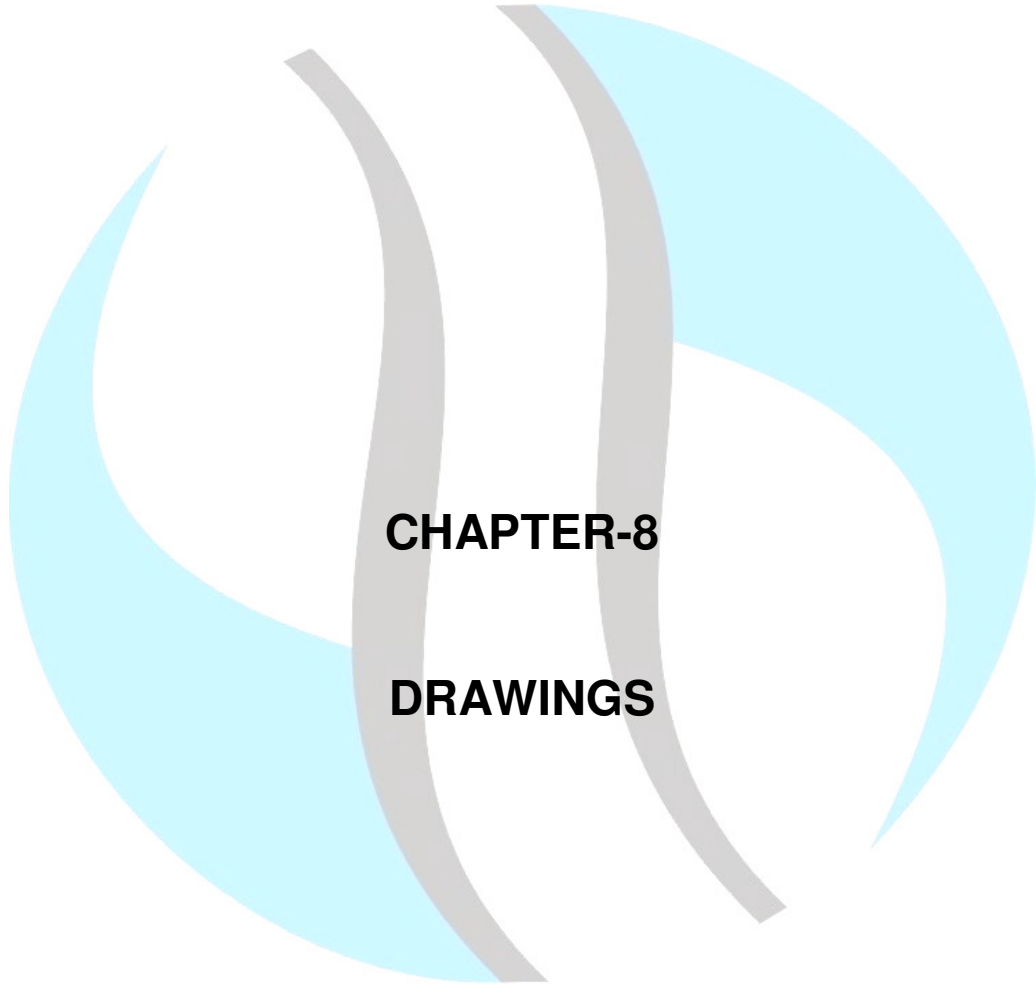

CHAPTER-8

DRAWINGS

रेलटेल
RAILTEL

A Government of India
Undertaking

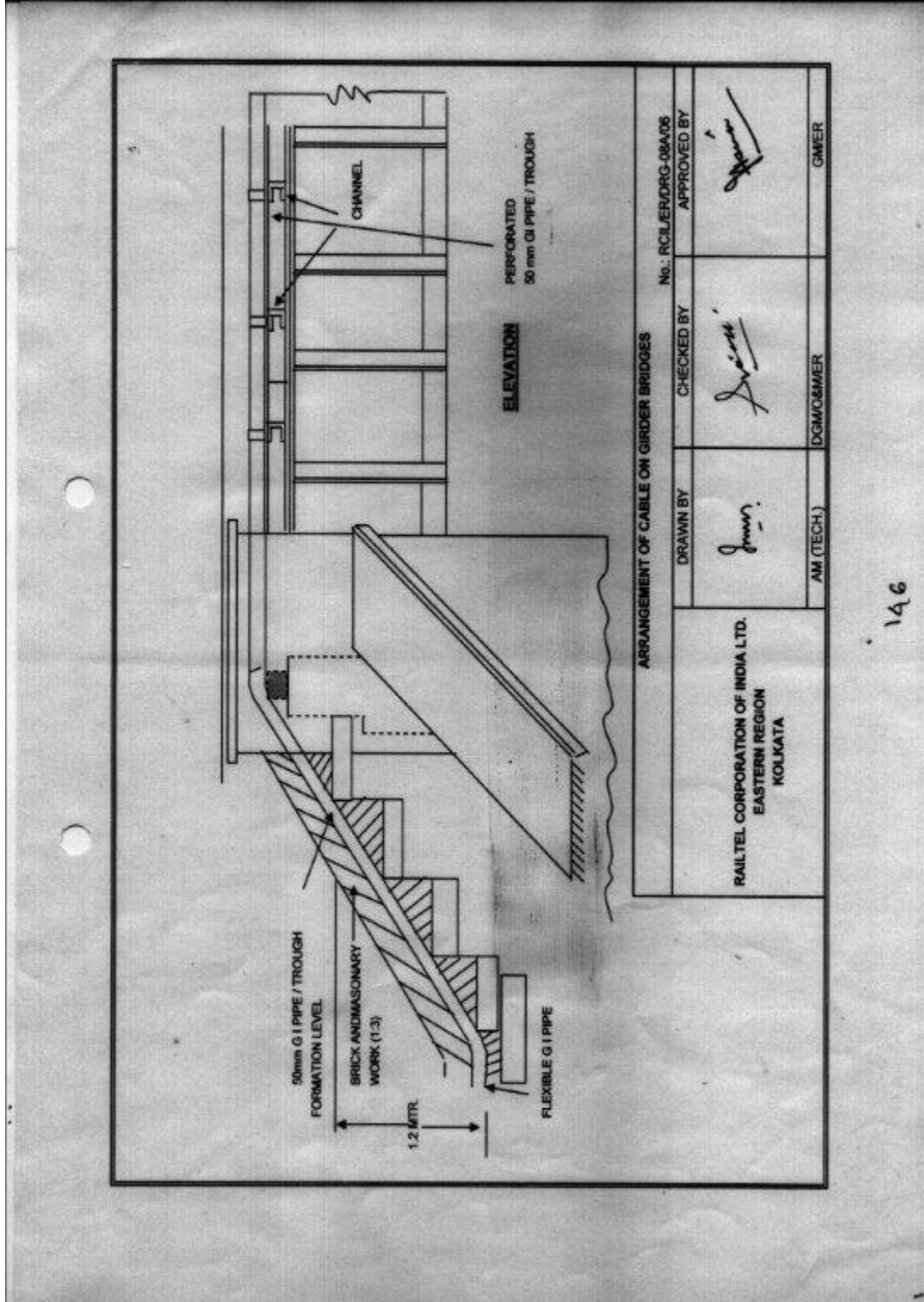

A Government of India
Undertaking

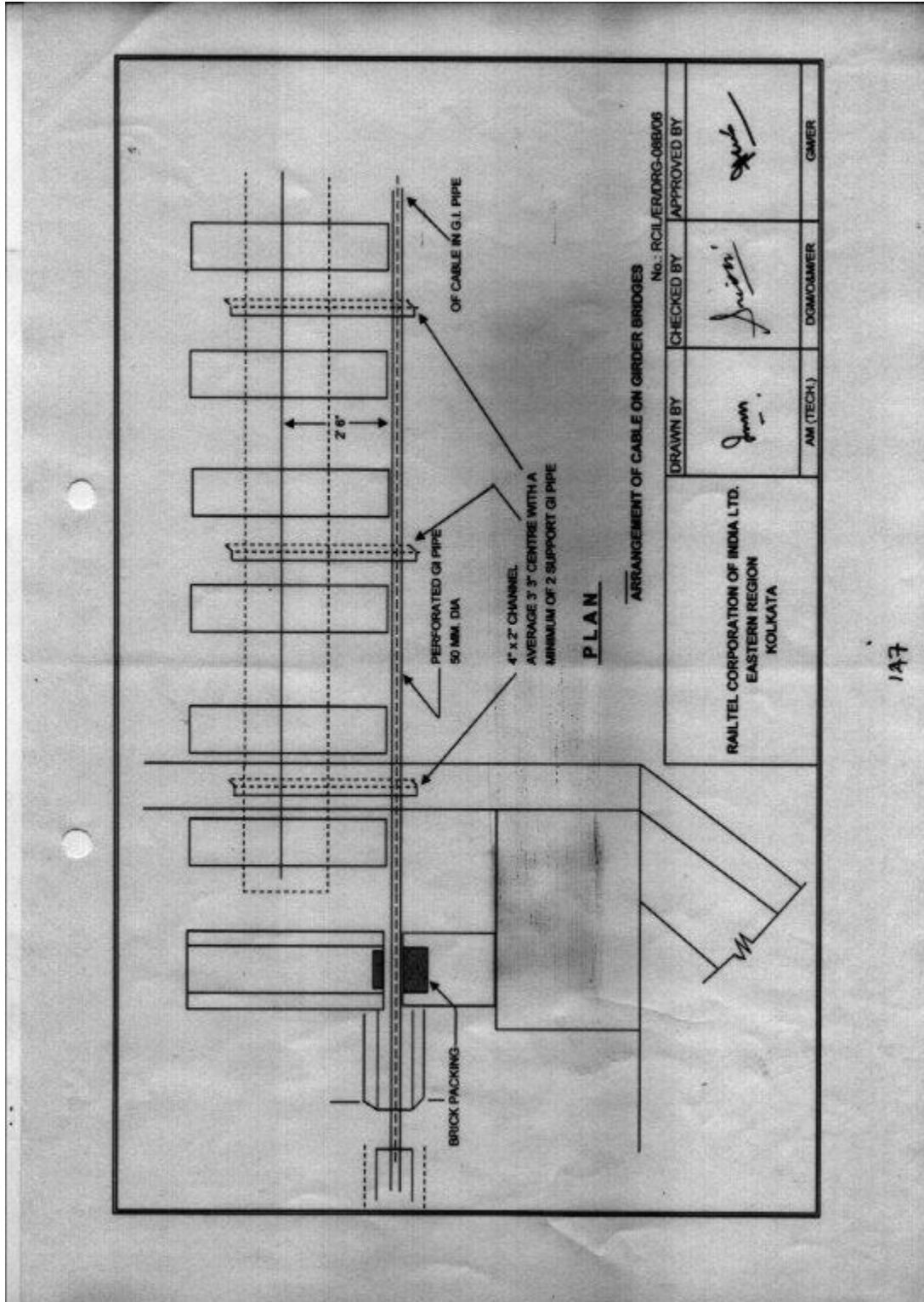

PLAN

ARRANGEMENT OF CABLE ON GIRDER BRIDGES

No.: RCIL/ERDRG-08B/06

DRAWN BY <i>Jain</i>	CHECKED BY <i>Jain</i>	APPROVED BY <i>Jain</i>	GAMER
RAIL TEL CORPORATION OF INDIA LTD. EASTERN REGION KOLKATA			DOM/COMMER
			AM (TECH.)

1A7

A Government of India
Undertaking

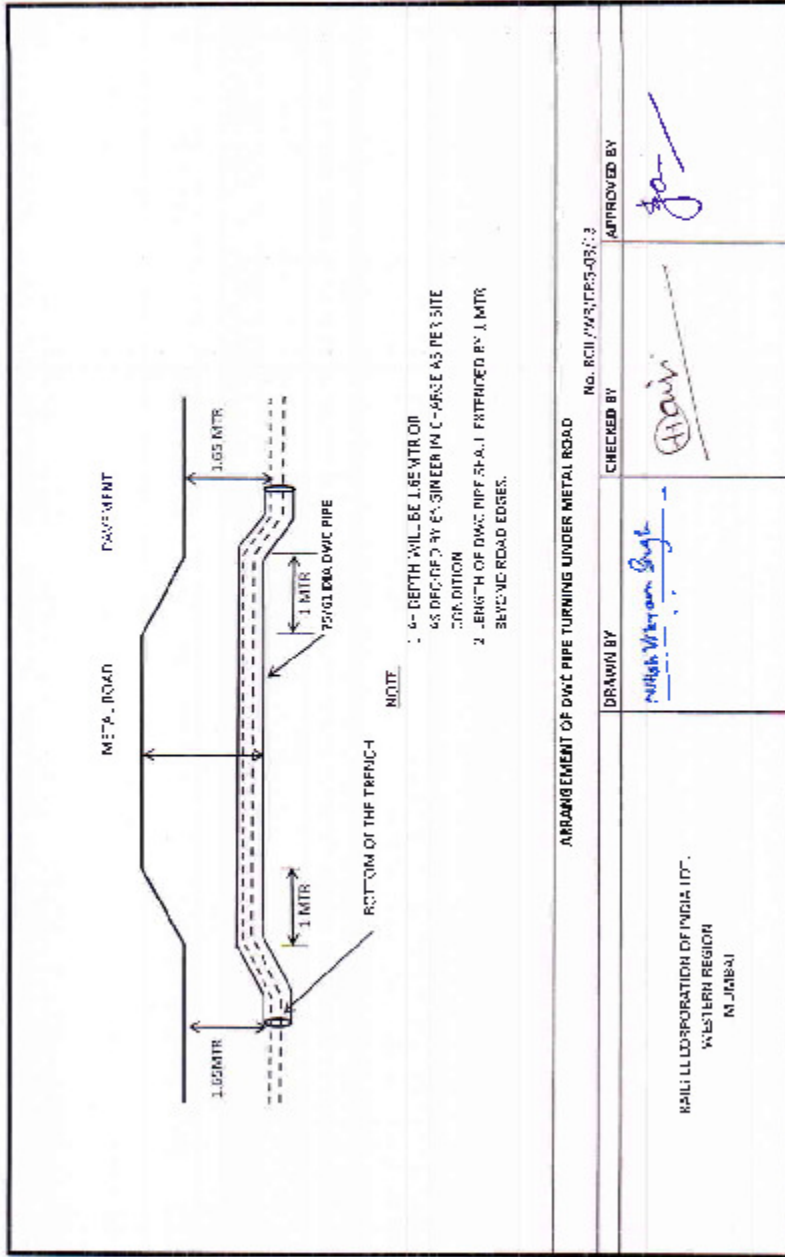

ARRANGEMENT OF DWAC PIPE TURNING UNDER METAL ROAD			
		No. RCII/WR/OT/NOFN/2017-18/52	APPROVED BY
		DRAWN BY	CHECKED BY
RAIL CORPORATION OF INDIA LTD. WESTERN REGION MUMBAI		<i>Mishra Vikram Singh</i>	<i>H. D. Wani</i>
			<i>[Signature]</i>

A Government of India
Undertaking

Indicative Drawing of Track Crossing

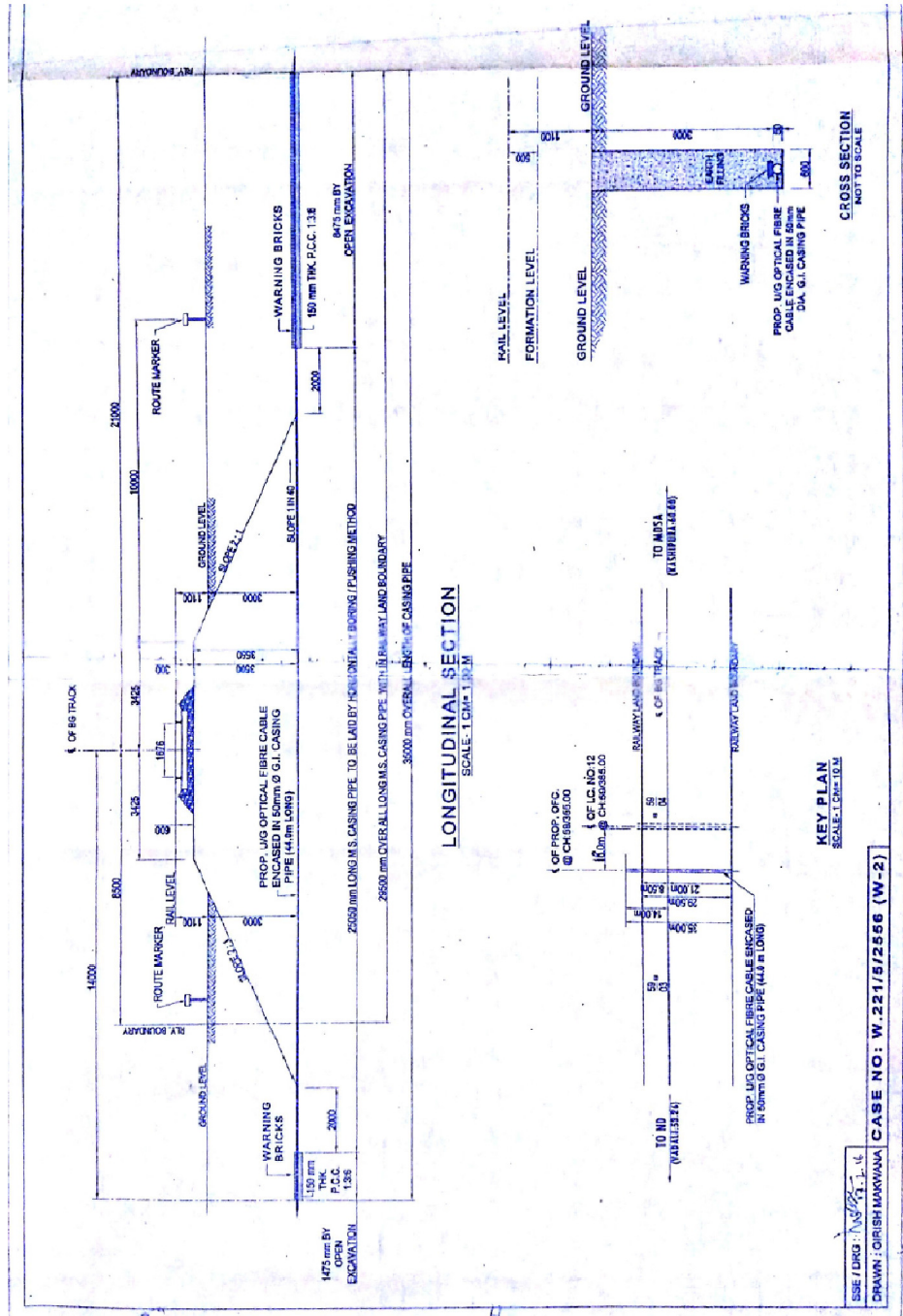

A Government of India Undertaking

