



रेलटेल कॉर्पोरेशन ऑफ इंडिया लिमिटेड
पश्चिमी क्षेत्र
RAILTEL CORPORATION OF INDIA LIMITED
Western Region

ई-निविदा दस्तावेज़
E-TENDER DOCUMENT

ई-निविदा सं. : रेलटेल/प.क्षे./ई-निविदा/खु.नि./2023-24/ओएफसी पैच रिप्लेसमेंट/01 आर-2

E-Tender No. : RailTel/WR/E-Tender/OT/2023-24/OFC Patch Replacement/01R-2

दिनांक/Date : 21.03.2024

कार्य का नाम : पश्चिमी क्षेत्र के मुंबई अंचल में विभिन्न खंडों में ओएफसी पैच रिप्लेसमेंट के लिए आपूर्ति, स्थापना, ट्रेंचिंग/ एचडीडी/ क्लैम्पिंग, डक्ट बिछाना, ओएफसी की डक्ट्स के माध्यम से ब्लोइंग, स्प्लाइसिंग, टेस्टिंग और कमीशनिंग।

Name of Work : Supply, Installation, Trenching/HDD/Clamping, Laying of Duct, Blowing of OFC through Ducts, Splicing, Testing & Commissioning for OFC Patch Replacement at various sections of Mumbai Territory of Western Region.

कार्यालय का पता :
प्रधान कार्यकारी निदेशक
पश्चिमी क्षेत्र,
रेलटेल कॉर्पोरेशन ऑफ इंडिया लिमिटेड
पश्चिमी रेलवे माइक्रोवेव कॉम्प्लेक्स,
सेनापति बापट मार्ग, महालक्ष्मी (पश्चिम),
मुंबई – 400013

Office Address :
Principal Executive Director
Western Region,
RailTel Corporation of India
Western Railway Microwave Complex,
Senapati Bapat Marg, Mahalaxmi (West)
Mumbai - 400013

INDEX

CH NO.	SUBJECT	PAGE No.
0	E-TENDER NOTICE/ CHECKLIST	3-9
1	PREAMBLE	10-15
2	SCHEDULE OF REQUIREMENTS	16 &160
3	INSTRUCTIONS TO TENDERERS AND CONDITIONS OF TENDERING	17-32
4	GENERAL CONDITION OF CONTRACT	33-64
5	SPECIAL CONDITIONS OF CONTRACT	65-86
6	FORMS OF TENDERS	87-106
7	TECHNICAL SPECIFICATION AND INSTRUCTIONS	107-141
8	LIST OF ADDRESS FOR SPECIFICATION	142
9	DRAWINGS	143-159

RAILTEL

A Government of India
Undertaking

E- TENDER NOTICE

RailTel Corporation of India Ltd., Western Railway Microwave Compound, Senapati Bapat Marg, Mahalaxmi, Mumbai-400013 invites Open E-Tender for the work of - **Supply, Installation, Trenching/HDD/Clamping, Laying of Duct, Blowing of OFC through Ducts, Splicing, Testing & Commissioning for OFC Patch Replacement at various sections of Mumbai Territory of Western Region.**

1	Name of work	Supply, Installation, Trenching/HDD/Clamping, Laying of Duct, Blowing of OFC through Ducts, Splicing, Testing & Commissioning for OFC Patch Replacement at various sections of Mumbai Territory of Western Region.
2	E-Tender No.	RailTel/WR/E-Tender/OT/2023-24/OFC Patch Replacement/01R-2
3	Last date & time for submission of tender	11.04.2024 up to 15:00 hrs.
4	Opening date & time of tender documents.	11.04.2024 at 15:30 hrs.
5	Validity of offer	45 days from the date of opening of tender.
6	Approximate Cost	Mumbai Territory : Rs. 2,29,75,704/-
7	EMD	Mumbai Territory : Rs. 4,59,600/-
8	Completion period	06 Months from date of LOA
9	Web address for availability of tender document and submission of Tender	www.ireps.gov.in
10	Cost of Tender document	Mumbai Territory : Rs. 2,950/-
11	Bidding Start Date	21.03.2024
12	TReDS feature available	Yes, on m1xchange portal (url: https://www.m1xchange.com)

Note: If the Tender document is downloaded from the website then the cost of e-tender document as stated above has to be submitted through net banking or payment gateway only on website www.ireps.gov.in.

- (i) The rates should be inclusive of taxes, however, breakup of all the taxes charged by the bidder shall be shown separately. The tenderer has to submit the breakup of all taxes at the time of submission of their "Tax invoices" also. The tenderer has also to submit their GSTIN No. at the time of submissions of their "Tax invoices". In addition to it, the contractor should submit copy of GSTIN registration certificate for the states wherever applicable. PF Account & ESI registration no. should also be available with the contractor. All the statutory provisions have to be made by the contractor. In case of the successful tenderer is not liable to be registered under CGST/IGST/UTGST/SGST Act, the RailTel shall deduct the applicable GST from his/their bill under RCM and deposit the same to the concerned tax authority. Vendor should file GST return and transfer credit of GST in RailTel account as per GST procedure.

- (ii) All future information viz. corrigendum/addendum/amendments etc. for this tender shall be posted on e-tender portal only.
- (iii) The offers shall be opened on above said date, in the presence of those bidders, who choose to be present. If the above said date happens to be a holiday, the same shall be opened on the next working day.
- (iv) Late/Delayed/incomplete tenders and tenders without submission of EMD and tender document fee will be summarily rejected.
- (v) Tender can be viewed and submitted through website www.ireps.gov.in only. Printed copy of tender document will not be sold from RailTel Office. Tender document can be seen on RailTel's website www.railtelindia.com
- (vi) Payment of Tender Document Cost (TDC), in respect of e-tendering, will be accepted through net banking or payment gate way only.
- (vii) The tenderer shall submit documents in support of his/their claim to fulfil the eligibility criteria as mentioned in the tender document. Each page of copy of documents / certificates in support of credentials, submitted by tenderer, shall be self-attested / digitally signed by the tenderer or authorized representative of the tendering firm. Self – attestation shall include signature, stamp and date (On each page). Only those documents which are declared explicitly by the tenderer as “documents supporting the claim of qualifying the laid down eligibility criteria”, will be considered for evaluating his/their tender.
- (viii) Each Territory SOR will be Treated as Separate Tender and Evaluation will be done as per Tender Para 3.16 Qualifying Criteria.
- (ix) “The tenderers shall submit a notarized affidavit on a non-judicial stamp paper stating that they are not liable to disqualified and all their statements/documents submitted along with bid are true and factual. Standard format of the affidavit to be submitted by the bidder is given in tender document (**Form 15**). Non submission of an affidavit by the bidder shall result in summery rejection of his/their bid. And it shall be mandatorily incumbent upon the tenderer to identify, state and submit the supporting documents duly self-attested by which they/he is qualifying the Qualifying Criteria mentioned in the Tender Document.
- (x) Small scale units registered with NSIC under single point registration scheme or registered as Micro, Small and Medium Enterprises under MSMED Act 2006 with District Industries Centres or Khadi & Village Industries Commission or Khadi & Village Industries Board or Coir Board or Directorate of Handicrafts & Handloom or any other body specified by Ministry of Micro, Small & Medium Enterprise and participating in this tender, are exempted from paying cost of tender document. In case firm is registered with NSIC or under MSMED copy of valid registration certificate with supply of T&P item, any Telecom / Computer work, any Electrical work as per NIT for the exemption is to be submitted. These exemptions shall be applicable provided units are registered with NSIC or under MSMED for tendered

item and registration is current and valid. Firm claiming these exemptions are required to submit copy of valid registration certificate with same scope of work as per NIT, along with their offer otherwise their offer would not be considered.

Note: The Terms and Conditions in Tender Document will prevail over Notifications/Instructions/Guidelines on Tendering portal.

**For Principal Executive Director,
Western Region,
For and on behalf of RailTel Corporation of India Limited**



रेलटेल
RAILTEL

A Government of India
Undertaking

ई-निविदा सूचना

रेलटेल कॉर्पोरेशन ऑफ इंडिया लिमिटेड, वेस्टर्न रेलवे माइक्रोवेव कंपाउंड, सेनापति बापट मार्ग, महालक्ष्मी, मुंबई-400013 निम्नलिखित के कार्य के लिए खुली ई-निविदा आमंत्रित करता है - पश्चिमी क्षेत्र के मुंबई अंचल में विभिन्न खंडों में ओएफसी पैच रिप्लेसमेंट के लिए आपूर्ति, स्थापना, ट्रेचिंग/ एचडीडी/ क्लैम्पिंग, डक्ट बिछाना, ओएफसी की डक्ट्स के माध्यम से ब्लोइंग, स्प्लाइसिंग, टेस्टिंग और कमीशनिंग।

1	कार्य का नाम	पश्चिमी क्षेत्र के मुंबई अंचल में विभिन्न खंडों में ओएफसी पैच रिप्लेसमेंट के लिए आपूर्ति, स्थापना, ट्रेचिंग/ एचडीडी/ क्लैम्पिंग, डक्ट बिछाना, ओएफसी की डक्ट्स के माध्यम से ब्लोइंग, स्प्लाइसिंग, टेस्टिंग और कमीशनिंग।
2	ई-निविदा सं.	रेलटेल/प.क्षे./ई-निविदा/खु.नि./2023-24/ओएफसी पैच रिप्लेसमेंट/01आर-2
3	निविदा जमा करने की अंतिम तिथि और समय	11.04.2024 को 15:00 बजे तक
4	निविदा दस्तावेजों के खुलने की तारीख और	11.04.2024 को 15:30 बजे.
5	ऑफर की वैधता	निविदा खोलने की तारीख से 45 दिन।
6	अनुमानित लागत	मुंबई क्षेत्र : Rs. 2,29,75,704/-
7	ईएमडी	मुंबई क्षेत्र : Rs. 4,59,600/-
8	पूर्ण करने की अवधि	एलओए की तारीख से 06 महीने
9	निविदा दस्तावेज की उपलब्धता और निविदा प्रस्तुत करने के लिए वेब पता	www.ireps.gov.in
10	निविदा दस्तावेज की लागत	मुंबई क्षेत्र : Rs. 2,950/-
11	बोली प्रारंभ तिथि	21.03.2024
12	TReDS सुविधा उपलब्ध है	हाँ, m1xchange पोर्टल पर (url: https://www.m1xchange.com)

नोट: यदि निविदा दस्तावेज वेबसाइट से डाउनलोड किया गया है तो ऊपर बताए अनुसार ई-निविदा दस्तावेज की कीमत नेट बैंकिंग या पेमेंट गेट वे के माध्यम से केवल वेबसाइट www.ireps.gov.in पर जमा करनी होगी।

- (i) दरों में कर शामिल होना चाहिए, हालांकि, बोली लगाने वाले द्वारा लगाए गए सभी करों का ब्रेकअप अलग से दिखाया जाएगा। निविदाकर्ता को अपने "कर चालान" भी जमा करने के समय सभी करों का ब्रेकअप प्रस्तुत करना होगा। निविदाकर्ता को अपने "कर चालान" प्रस्तुत करने के समय अपना जीएसटीआईएन नंबर भी जमा करना होगा। इसके अलावा, ठेकेदार को जहां भी लागू हो, राज्यों के जीएसटीआईएन पंजीकरण प्रमाण पत्र की प्रति जमा करनी होगी। पीएफ खाता और ईएसआई पंजीकरण संख्या। ठेकेदार के पास भी उपलब्ध होना चाहिए। सभी वैधानिक प्रावधान ठेकेदार द्वारा किए जाने हैं। यदि सफल निविदाकार सीजीएसटी/आईजीएसटी/ यूटीजीएसटी/ एसजीएसटी अधिनियम के तहत पंजीकृत होने के लिए उत्तरदायी नहीं है, तो रेलटेल आरसीएम के तहत उसके/उनके बिल से लागू जीएसटी की कटौती करेगा और उसे

संबंधित कर प्राधिकरण को जमा करेगा। विक्रेता को जीएसटी रिटर्न दाखिल करना चाहिए और जीएसटी प्रक्रिया के अनुसार रेलटेल खाते में जीएसटी का हस्तांतरण करना चाहिए।

- (ii) भविष्य की सभी जानकारी जैसे। इस निविदा के लिए शुद्धिपत्र/परिशिष्ट/संशोधन इत्यादि केवल ई-निविदा पोर्टल पर पोस्ट किए जाएंगे।
- (iii) प्रस्ताव उक्त तिथि को उन बोलीदाताओं की उपस्थिति में खोले जाएंगे, जो उपस्थित रहना चाहते हैं। उक्त तिथि को अवकाश होने पर अगले कार्य दिवस को खोला जायेगा।
- (iv) विलंबित/विलंबित/अपूर्ण निविदाएं और ईएमडी और निविदा दस्तावेज शुल्क की घोषणा के बिना निविदाओं को सरसरी तौर पर खारिज कर दिया जाएगा।
- (v) निविदा केवल वेबसाइट www.ireps.gov.in के माध्यम से देखी और प्रस्तुत की जा सकती है। निविदा दस्तावेज की मुद्रित प्रति रेलटेल कार्यालय से नहीं बेची जाएगी। निविदा दस्तावेज रेलटेल की वेबसाइट www.railtelindia.com पर देखा जा सकता है।
- (vi) ई-निविदा के संबंध में निविदा दस्तावेज लागत (टीडीसी) का भुगतान नेट बैंकिंग या पेमेंट गेट वे के माध्यम से ही स्वीकार किया जाएगा।
- (vii) निविदाकर्ता निविदा दस्तावेज में उल्लिखित पात्रता मानदंड को पूरा करने के लिए अपने दावे के समर्थन में दस्तावेज प्रस्तुत करेगा। निविदाकर्ता द्वारा प्रस्तुत क्रेडेंशियल्स के समर्थन में दस्तावेजों / प्रमाणपत्रों की प्रति का प्रत्येक पृष्ठ, निविदाकर्ता या निविदाकर्ता फर्म के अधिकृत प्रतिनिधि द्वारा स्व-सत्यापित / डिजिटल रूप से हस्ताक्षरित होना चाहिए। स्व-सत्यापन में हस्ताक्षर, मुहर और तारीख (प्रत्येक पृष्ठ पर) शामिल होगी। केवल वे दस्तावेज जो निविदाकर्ता द्वारा स्पष्ट रूप से घोषित किए गए हैं, "पात्रता मानदंड को पूरा करने के दावे का समर्थन करने वाले दस्तावेज" के रूप में उनकी निविदा के मूल्यांकन के लिए विचार किया जाएगा।
- (viii) प्रत्येक अंचल के एसओआर की अलग निविदा मानी जाएगी और निविदा अनुच्छेद 3.16 पात्रता मानदंड के अनुसार मूल्यांकन किया जाएगा।
- (ix) "निविदाकर्ता एक गैर-न्यायिक स्टाम्प पेपर पर एक नोटरीकृत हलफनामा प्रस्तुत करेंगे, जिसमें कहा गया है कि वे अयोग्य घोषित करने के लिए उत्तरदायी नहीं हैं और बोली के साथ प्रस्तुत किए गए उनके सभी विवरण / दस्तावेज सत्य और तथ्यात्मक हैं। बोलीदाता द्वारा प्रस्तुत किए जाने वाले शपथ पत्र का मानक प्रारूप निविदा दस्तावेज (फॉर्म 15) में दिया गया है। बोलीदाता द्वारा हलफनामा प्रस्तुत न करने पर उसकी/उनकी बोली को समरी रिजेक्शन कर दिया जाएगा। और यह अनिवार्य रूप से निविदाकर्ता के लिए अनिवार्य होगा कि वे सहायक दस्तावेजों की पहचान करें, बताएं और विधिवत स्व-सत्यापित करें, जिसके द्वारा वे निविदा दस्तावेज में उल्लिखित योग्यता मानदंड को पूरा कर रहे हैं।
- (x) एकल बिंदु पंजीकरण योजना के तहत एनएसआईसी के साथ पंजीकृत छोटी इकाइयां या जिला उद्योग केंद्रों या खादी और ग्रामोद्योग आयोग या खादी और ग्रामोद्योग बोर्ड या कयर बोर्ड या हस्तशिल्प निदेशालय के

साथ एमएसएमईडी अधिनियम 2006 के तहत सूक्ष्म, लघु और मध्यम उद्यमों के रूप में पंजीकृत & हथकरघा या सूक्ष्म, लघु और मध्यम उद्यम मंत्रालय द्वारा निर्दिष्ट और इस निविदा में भाग लेने वाले किसी अन्य निकाय को निविदा दस्तावेज की लागत से छूट दी गई है। यदि फर्म एनएसआईसी के साथ पंजीकृत है या टी एंड पी मद की आपूर्ति के साथ वैध पंजीकरण प्रमाण पत्र की एमएसएमईडी के तहत, किसी भी दूरसंचार / कंप्यूटर कार्य, एनआईटी के अनुसार किसी भी विद्युत कार्य को छूट के लिए प्रस्तुत किया जाना है। ये छूट तब लागू होंगी जब निविदा मद के लिए इकाइयां एनएसआईसी या एमएसएमईडी के तहत पंजीकृत हों और पंजीकरण वर्तमान और वैध हो। इन छूटों का दावा करने वाली फर्म को अपने प्रस्ताव के साथ एनआईटी के अनुसार कार्य के समान दायरे के वैध पंजीकरण प्रमाण पत्र की प्रति जमा करनी होगी अन्यथा उनके प्रस्ताव पर विचार नहीं किया जाएगा।

नोट: निविदा दस्तावेज में नियम और शर्तें निविदा पोर्टल पर अधिसूचनाओं/निर्देशों/दिशानिर्देशों पर प्रबल होंगी।

प्रधान कार्यकारी निदेशक के लिए,
पश्चिमी क्षेत्र,
रेलटेल कॉर्पोरेशन ऑफ इंडिया लिमिटेड के लिए और उनकी ओर से

रेलटेल
RAILTEL

A Government of India
Undertaking

CHECKLIST FOR SUBMISSION OF OFFER

Tender should submit their offer on online only, on website www.ireps.gov.in

Sr. No.	Item	Remarks (Submitted/ Not Submitted)
1	Tender Document Cost (TDC) (On line payment)	
2	Earnest Money Deposit (EMD) (On line payment)	
3	If the Firm is registered with MSME/NSIC, with same scope of work as per Tender, the Valid Certificate is required to be submitted to claim exemption in paying Tender Document Cost (TDC).	
4	Offer Letter duly signed by authorized signatory (Form 1)	
5	Upload Digitally Signed Copy of Tender Document/ Corrigenda/Addenda	
6	Eligibility / Credential Certificate (For the work above Rs. 50 Lakh)	
7	Affidavit Form No. 15 (duly Notarized)	
8	Power of Attorney to Signing the Bid	
9	GST Registration Details	
10	Break-up of taxes/duties as per proforma	
11	Additional Documents enclosed with offer, if any	

RailTel's Bank account details for Tender Document Cost & Earnest money Deposit are as below:-

1	Name of the Branch & Address	State Bank of India, Churchgate Branch, Maharshi Karve Marg, Mumbai- 400 020
2	Name of Account Holder	RailTel Corporation of India Limited
3	Account No.	11037321307
4	IFSC Code	SBIN0001821
5	Branch Code	001821

Signature of the Tenderer

RAILTEL
A Government of India
Undertaking

CHAPTER-1

PREAMBLE

Index

- 1.1 Scope of Work**
- 1.2 Tender Bid**
- 1.3 Qualifying Criteria**
- 1.4 Last Date of Submission**
- 1.5 Date of Opening of Tender**
- 1.6 RailTel Reserves the Right**
- 1.7 Work Load**
- 1.8 Validity of Offer**
- 1.9 Completion Period of Work**
- 1.10 Address for correspondence**
- 1.11 Earnest Money**
- 1.12 Security Deposit**
- 1.13 Performance Bank Guarantee**
- 1.14 Specifications**
- 1.15 Schedule of Requirement**
- 1.16 Work to be done by RailTel**
- 1.17 Materials to be supplied by RailTel**
- 1.18 Materials to be supplied by Contractor**
- 1.19 Submission**
- 1.20 Warranty Support**
- 1.21 Trade Receivables Discounting System (TReDS) for MSME**

रेलटेल
RAILTEL
A Government of India
Undertaking

Preamble

1.0 Name of work :

Supply, Installation, Trenching/HDD/Clamping, Laying of Duct, Blowing of OFC through Ducts, Splicing, Testing & Commissioning for OFC Patch Replacement at various sections of Mumbai Territory of Western Region.

1.1 Scope of Work: As per Schedule of Requirement (SOR) at various sections of Mumbai Territory of Western Region.

The scope of work shall broadly comprise of survey, supply, installation, testing and commissioning of OFC, G.I. Pipe, DWC Pipe, FDMS, OFC Joint Chambers, HDPE duct including all the accessories and all other items required to meet the end objective, trenching, duct laying, providing necessary protection as per Engineering Instructions wherever required, back filling, OFC blowing, splicing of fiber , rectification of fibers, route indicators, joining chambers, manhole chamber, route markers, jointing of the cable end with existing or newly laid OFC and termination of fibres at FDMS/FTB as is where required. The contractor shall be required to supply, install, commission and test the overall deployment at each site which includes OTDR testing, Power meter testing, as-build drawings etc. as per Engineering instructions.

Contractor shall deploy multiple teams at various sections to execute work simultaneously and completion of all work in stipulated due timeline.

Any additional item which is not mentioned in the SoR but required to complete the work shall be provided by the contractor without any additional cost.

Section name and work details are as follows:

Sr. No.	Territory Name	Section Name	OFC to be laid	RKM
1	Mumbai	Vasai-Kopar-Juinagar	24F	10.2
2		Vasai-Ukai Songadh	24F	12.24
3		Ukai Songadh-Jalgaon	24F	8.16
4		Lonavala-Pune-Daund-Bhigwan	24F	6.12
5		Bhigwan-Wadi	24F	6.12
6		Kurduwadi-Latur road	24F	6.12
7		Kurduwadi-Miraj	24F	6.12
8		Daund-Manmad	24F	6.12
Total RKM in Mumbai Territory				61.2

The locations can be modified as per requirement of Railway or RailTel.

1.2 Tender Bid

The e-tender can be viewed and submitted through web site www.ireps.gov.in only. The tenderer / bidder must have Class-III Digital signature Certificate and must be registered on IREPS portal. Only registered tenderer/bidder can participate in e-tendering. All relevant documents must be uploaded at the time of participating in e-tendering. Manual offers are not allowed for e-tender and any such manual offer received shall not be opened/accepted.

Last date & time of submission of queries/clarifications: One week before bid start date. It is requested that any queries/clarifications regarding the tender may be sent through e-mail to nikhil.bhatwalkar@railtelindia.com (in word format) by authorized person only.

1.3 Qualifying Criteria:

For qualifying in the tender, the tenderer shall be required to meet the eligibility requirement as given in Para 3.16 of tender document. Fulfilling of eligibility criteria as mentioned in the tender document is pre-requisite for the consideration of the offer of the tenderer.

1.4 Last date of Submission

The tenderer shall submit their offer online only up to date mentioned in e-Tender Notice.

1.5 Date of Opening of Tender

The tenders will be opened at 15.30 hrs on the date mentioned at the address as below :-
Principal Executive Director, RailTel Corporation of India Limited, Western Railway Microwave Complex, Senapati Bapat Marg, Mahalaxmi, Mumbai - 400 013.

1.6 RailTel reserves the right:-

- a) To verify, if so desired, the correctness of documentary evidence furnished by the tenderer.
- b) To carry out capability assessment of the bidder(s) including referral to in-house information.
- c) RailTel shall not be responsible for any delay in the receipt of tender and reserves the right to accept/reject any or all tenders.
- d) To change / modify the existing location/site of the work as per requirement.

1.7 Work Load:

The tenderer to submit the present work load of the telecom contracts in hand as per the format (Form No 9). The performance of the tenderer with regard to satisfactory execution of more than one contract simultaneously in the past shall be taken into account.

1.8 Validity of Offer

The tenderer shall keep the offer open as mentioned in e-tender notice. Within that period the tenderer, can't withdraw his offer. This period can be extended further, if required, by mutual agreement from time to time. Any contravention of the above condition will make the tenderer liable for forfeiture of his Earnest Money.

1.9 Completion Period of Work:

As mentioned in e-Tender Notice.

1.10 Address for correspondence :-

Principal Executive Director,
RailTel Corporation of India Limited,
Western Railway Microwave Complex,
Senapati Bapat Marg, Mahalaxmi (W), Mumbai - 400 013

1.11 Earnest Money :

- (i) Earnest Money as per Tender Notice shall be submitted online only.
- (ii) The EMD may be forfeited if a bidder withdraws his offer or modifies the terms and conditions of the offer before validity period and in the case of a successful bidder, if the bidder fails to accept the Letter of Acceptance and furnish Performance Security as per time lime line given.
- (iii) Tenders not accompanied by Earnest Money shall be summarily rejected.
- (iv) Earnest Money of the unsuccessful bidder will be discharged/returned as promptly as possible.

1.12 Security Deposit

Security deposit shall be 5% of the contract value as detailed in Para 4.16 of tender document. The amount shall be recovered from the running bills of the contract (@10% of per bill amount) and no other mode of collecting SD shall be accepted.

1.13 Performance Bank Guarantee

The successful bidder is required to give a Performance Bank Guarantee in the form of an irrevocable Bank Guarantee amounting to 5% of the contract value for schedule as perform for successful completion of the work as detailed in Para 4.16.2 of Tender document No other form of bank guarantee will be accepted except schedule bank guarantee.

Note:

- 1) A separate advice of the BG will invariably be sent by the BG issuing bank to the RailTel's Bank through SFMS and only after this the BG will become acceptable to RailTel. It is therefore in own interest of bidder to obtain RailTel's bank IFSC code, its branch and address and advise these particulars to the BG issuing bank and request them to send advice of BG through SFMS to the RailTel's Bank.
- 2) Any performance security up to a value of Rs. 5 Lakhs is to be submitted through online transfer only.

No Interest on Earnest Money and Performance Security:

No interest shall be paid on the amount of earnest money and Performance Security held by RailTel, at any stage.

1.14 Specifications

Reference of specifications of the important equipments and materials required for execution of the contract is given in the Technical Specification. The work shall be executed in compliance with all the technical requirements given therein. Drawings are indicative. In case of any mismatch or confusion, the decision of EIC shall be final.

1.15 Schedule of Requirement

The various items to be supplied and execution of the work by the tenderer for the section are indicated in Schedule of Requirement of this tender document. Payment of supplied items shall be done along with the payment of execution after the measurement.

1.16 Work to be done by RailTel

To arrange clearances/Permissions from Railway/PSU in connection with execution of work. Provision of maintenance blocks on demand of contractor through Site Engineer/In-charge to work on live networks.

1.17 Materials to be supplied by RailTel :

No any material will be provided by RailTel. Complete Supply, Storage, Transportation and Installation of materials shall be done by contractor.

1.18 Materials to be supplied by Contractor

As per Schedule of Requirement. Any additional item which is not mentioned in the SoR but required to complete the work shall be provided by the contractor without any additional cost.

1.19 Submission

1.19.1 The tenderer shall submit all the required information in the relevant forms attached to this document and suitably numbering each page of the bid documents with a content list indicating availability of various documents with their serial numbers. In the absence of numbering of pages and the content list, there is a likelihood of any important document going unnoticed for which the tenderer shall be solely responsible.

1.19.2 Before submitting a tender the tenderer will be deemed to have satisfied himself by actual inspection of the site and locality of the works, that all conditions liable to be encountered during the execution of the works are taken into account and that the rates he enters in the tender forms are adequate and all inclusive to accord with the provisions for the completion of the entire satisfaction of the Engineer.

1.19.3 Tenderers will examine the various provisions of The Central Goods and Services Tax Act, 2017(CGST/Integrated Goods and Services Tax Act,2017(IGST)/ Union Goods and Services Tax Act,2017(UGST)/ respective state's Goods and Services Tax Act (SGST) also, as notified by Central/State Govt. & as amended from time to time and applicable taxes before bidding. Tenderers will ensure that full benefits of Input Tax Credit (ITC) likely to be availed by them is duly considered while quoting rates.

1.19.4 The successful tenderer who is liable to be registered under CGST/IGST/UGST/SGST Act shall submit GSTIN along with other details required under CGST/IGST/UGST/SGST Act to RCIL immediately after the award of contract without which no payment shall be released to the contractor. The contractor shall be responsible for deposition of applicable GST to the concerned authority.

1.19.5 In case the successful tenderer is not liable to be registered under CGST/IGST/UGST/SGST Act, the RCIL shall deduct the applicable GST from his/ their bills under reverse charge mechanism (RCM) and deposit the same to the concerned authority.
Labour Cess shall be deducted from bills as applicable under Liability to pay cess under building and other construction workers welfare Act, 1996 and deposited in relevant state where work is being executed.

1.20 Warranty Support

All material supplied & works executed should be covered under warranty as per Para 5.29 and 5.15 of tender document.

1.21 Trade Receivables Discounting System (TReDS) for MSME

Refer Para 3.5.9 of Tender Document for availing the facility of bill discounting on TReDS platform.



रेलटेल
RAILTEL

A Government of India
Undertaking

CHAPTER - 2

SCHEDULE OF RATE / REQUIREMENT

(Please see pages 161 to 162)

रेलटेल
RAILTEL

A Government of India
Undertaking

CHAPTER - 3

INSTRUCTIONS TO TENDERERS AND CONDITIONS OF TENDERING

INDEX

- 3.1 General Instructions**
- 3.2 Interpretations**
- 3.3 Local Conditions**
- 3.4 Compliance to Tender Conditions, Specifications and Drawings**
- 3.5 Earnest Money**
- 3.6 Submission of Offers**
- 3.7 Constitution of Firm and Power of Attorney**
- 3.8 Validity of Offer**
- 3.9 Rates during Negotiations**
- 3.10 Period of Completion and Time Progress Graph**
- 3.11 Opening of Tender**
- 3.12 Non-transferability and Non-refundability**
- 3.13 Errors, Omissions and Discrepancies**
- 3.14 Wrong Information by Tenderers**
- 3.15 Amendment of Bid Documents**
- 3.16 Qualifying Criteria**
- 3.17 Evaluation of offer**
- 3.18 Agreement**
- 3.19 Tenderer's Address**

रेलटेल
RAILTEL
A Government of India
Undertaking

INSTRUCTIONS TO TENDERERS AND CONDITIONS OF TENDERING

3.1 GENERAL INSTRUCTIONS

- 3.1.1 Tender is invited by RailTel, Western Region Mumbai, from established and reliable contractors for the work detailed in chapter 1.
- 3.1.2 The Special Conditions of Contract, Instructions to Tenderers and Conditions of Tendering, Technical Specifications & Supplement, Preamble including Schedule of Requirements and all Annexures & Forms etc. shall, hereafter, be collectively referred to as the "Tender documents ". These regulations for Tender and Contracts shall be read in conjunction with the General Conditions of contract and shall be subject to modifications, additions or suppression, overwrite by Special conditions of contract and/or special specifications, if any, annexed to the tender document.

3.2 INTERPRETATIONS

The following terms wherever occurring in the tender document and wherever used throughout the execution of the work, shall, unless excluded by or repugnant to the context, have the meaning attributed thereto as follows:

- a) "**CONTRACT**" Means the Contract resulting from the acceptance by the Purchaser of this Tender whether in whole or in part.
- b) "**CONTRACTOR**" Means the successful Tenderer, i.e., the Tenderer whose Tender has been accepted either in whole or in part.
- c) "**CONTRACTOR's REPRESENTATIVE**" Shall mean a person in supervisory capacity who shall be so declared by the Contractor and who shall be authorized under a duly executed power of attorney to receive materials issued by the Purchaser to the Contractor for the works. He shall be responsible for proper execution of works at each or all places and shall take orders from Purchaser's Engineers and carry out the same.
- d) "**ENGINEER / ENGINEER-IN-CHARGE**" Shall mean an executive of RailTel in charge of works and shall include the superior executives of RailTel He is responsible for ensuring that all field works covered by the contract are carried out in accordance with approved designs, drawings & specifications and conditions of contract as agreed to.
- e) "**ENGINEER'S REPRESENTATIVE**" Shall mean the supervisor of RailTel in direct charge of the works.
- f) "**EQUIPMENT**" Means all or any equipment considered necessary by the Purchaser's Engineers for satisfactory operation, as a whole, of the installations.
- g) "**MONTH**" Means any consecutive period of thirty days.
- h) "**MATERIALS**" Means all equipments, components, fittings and other materials including raw materials required to complete the work..

- i) **"PURCHASER"** Means RailTel Corporation of India Limited, Western Railway Microwave Compound, Senapati Bapat Marg, Mahalaxmi- Mumbai- 400 013
- j) **"PURCHASER'S ENGINEER"** Means the Executive Director of RailTel or successor who will decide all matters relating to design, manufacture, and installation and commissioning of the plant and equipment at site.
- k) **"SUB-CONTRACTOR"** Means an individual or a firm of Contractor or a Company registered under Indian Company Act or an approved supplier of materials to whom the Contractor sublets portions of the contract.
- l) **"CONSIGNEE"** Means the person specified in the Acceptance of Tender to whom Stores are to be delivered at the destination.
- m) **"INSPECTING OFFICER"** Means the person, or organization specified in the contract for the purpose of inspection of stores of work under the contract and includes his/their authorized representative.
- n) **"RailTel"** Means RailTel Corporation of India Limited, Western Region, Western Railway Microwave Complex, Senapati Bapat Marg, Mahalaxmi- Mumbai- 400 013.
- o) **"SITE"** Means the areas to be taken up by the permanent works, together with any other area or areas as shall be determined by the Purchaser's Engineer, which may be placed at the disposal of the Contractor for the purpose of the contract and also such area or areas used for store yards, works yards or workshop in proximity of the works as the Purchaser's Engineer may have authorized as an extension of the site, irrespective of the terms and conditions under which they are occupied by the Contractor.
- p) **"TENDERER"** Means and includes any firm of engineers or Contractors or any company or body, corporate or otherwise, who submit the Tender which has been invited.
- q) **"WORK OR WORKS"** Means all or any of the items of the work for which the Tenderer /Contractor has Tendered/contracted according to the specifications, drawings and Annexure hereto annexed or to be implied there from, or incidental thereto or to be hereafter specified or required in such explanatory instructions and drawings, being in conformity with the original specifications, drawings, Annexure and schedules and also such instructions and drawings additional to the aforementioned as may from time to time be issued by the Purchaser's Engineer during the progress of the contracted work.
- r) **"Near Relative"**:
The near relatives of all RailTel Employees either directly recruited or on deputation are prohibited from participation in tenders and execution of works in the different units of RailTel. The detailed guidelines in this regard are given in the following paragraphs:-
- i) The near relatives for this purpose are defined as:
* Members of a Hindu Undivided family,

- * They are husband and wife,
- * The one is related to the other in the manner as father, mother, son (s) & son's wife (daughter-in-law), Daughter(s), & daughter's husband (son-in-law), brother(s) & brother's wife, sister(s) & sister's husband (brother-in-law).

- ii) As per Government of India's CCS Conduct rule 4, no Government servant shall in the discharge of his official duties deal with any matter or sanction any contract to any company or for any other person if any member of his family is employed in that company or firm or under that person or if he or any member of his family is interested in such matter or contract in any other manner and the Govt. Servant shall refer every such matter or contract to his official superior. This clause is applicable to all RailTel employees in view of this as soon as any RailTel employee becomes aware of the above aspect, he must intimate this to the prescribed authority.
- iii) The Company or firm or any other person is not permitted to tender for works in RailTel Unit in which his near relative(s) is (are) posted. The tender/work will be cancelled and earnest money/security deposit will be forfeited at any stage whenever it is so noticed. The department will not pay any damages to the company or firm or the concerned person. The company or firm or the person will also be debarred for further participation in the concerned unit.

* The format of the certificate to be given is

"I

.....S/o.....r/o.....

..... hereby certify that none of my relative(s) as defined in the tender document is/ are employed in RailTel unit. In case at any stage, it is found that the information given by me is false/ incorrect, RailTel shall have the absolute right to take any action as deemed fit/without any prior intimation to me".

- s) **"WRITING"** Includes all matters written, typewritten or printed either in whole or in part.
- t) **"Constructional Plant"** shall mean all appliances or things of whatsoever nature required for the execution, completion or maintenance of the works or the temporary works (as hereinafter defined) but do not include materials or other things intended to form or forming part of the permanent work. (i) **"Temporary Works"** shall mean all temporary works of every kind required for the execution, completion and/or maintenance of the works. (ii) **"Period of maintenance"** shall mean the specified period of the maintenance from the date of completion of the work as certified by the Engineer.
- u) Singular and Plural: Works importing the singular number shall also include the plural and vice versa where the context requires.
- v) Headings & marginal headings: The headings and marginal headings in these general conditions are solely for the purpose of facilitating reference and shall not be deemed to be part thereof or be taken into consideration in the interpretation or construction thereof or the contract.
- w) **Sub section:** Distance in between two long haul Railway stations.

3.3 LOCAL CONDITIONS

- 3.3.1 It will be imperative on each tenderer to fully acquaint him with all the local conditions and factors which would have any effect on the performance of the contract and cost of the stores. The purchaser shall not entertain any request for clarifications from the tenderer regarding such local conditions. No request for the change of price or time schedule of delivery of stores shall be entertained after the offer is accepted on account of any local condition or factor.
- 3.3.2 The intending tenderer is advised to study the tender document carefully. Any submission of a quotation by the tenderer shall be deemed to have been done after a careful study and examination of these documents with full understanding of the implication thereof. These conditions and specifications shall be deemed to have been accepted unless otherwise, specifically commented upon by the Tenderer in his quotation. Failure to adhere to anyone or all these instructions may render his offer liable to be ignored without any reference.
- 3.3.3 Should a tenderer find discrepancies in, or omission from, the drawings or any of the Tender documents or he has any doubt to their meaning, he should at once notify the RailTel who may send a written clarification to all Tenderers.

3.4 COMPLIANCE TO TENDER CONDITIONS, SPECIFICATIONS & DRAWINGS

- 3.4.1 The tenderer shall indicate Paragraph by Paragraph for each section of the tender document that either his tender complies in every respect with the requirements of each clause and sub clause or if not, precisely how they differ from the requirements of the tender. In later case, the tenderer shall enclose a separate statement as per proforma given, indicating only the deviations for any clause or sub clause of Special Conditions of Contract, Instructions to Tenderers and Conditions of Tendering, Technical Specifications, Preamble etc. which he proposes with justifications for deviations proposed. The purchaser reserves the right to accept or reject these deviations and his decision thereon shall be final (see Form 5).
- 3.4.2 The equipment offered and execution of work shall be in accordance with the drawings and specifications. Details of variation from the drawings and specifications, if any, should be clearly indicated separately for each annexure with justification for deviations proposed. The Purchaser reserves the right to accept or reject these deviations and his decision thereon shall be final.
- 3.4.3 Firms should give details of similar works carried out giving details of the name of the project, date of award, length of the section, value of the contract, the original execution period and the actual execution time taken.
- 3.4.4 The tenderer should serially number all the pages of tender submitted.

3.5 EARNEST MONEY

- 3.5.1 The tenderer shall furnish an amount given in “Para-1.11 of tender document”
- 3.5.2 **The Earnest Money should be in any of the following forms**
Earnest Money as per Tender Notice shall be submitted online only.

- 3.5.3 The tenderers shall hold the offer open till such date as specified in Para 1.8 of the tender document. It being understood that the tender documents have been sold/issued to the tenderer and the tenderer has been permitted to tender in consideration of the stipulation on his part that after submitting his tender he will not resale from his offer or modify the terms and conditions thereof in a manner not acceptable to RailTel. If the tenderer fails to observe or comply with the foregoing stipulation, the aforesaid amount deposited as Earnest Money shall be liable to be forfeited by RailTel.
- 3.5.4 **The Earnest Money may be forfeited**
- If tenderer withdraws its tender during the period of tender validity specified in Para 1.8 of tender document.
 - In the case of successful tenderer, If the tenderer fails to sign the contract in accordance with Para 5.2 of Special Conditions of Contract and to furnish Performance Bank Guarantee in accordance with Para 1.13 of tender document.
- 3.5.5 The Earnest Money of unsuccessful tenderer will save as herein before provided, be returned within reasonable time to the unsuccessful tenderer but RailTel shall not be responsible for any loss or depreciation that may happen to the security for the due performance of the above stipulation to keep offer open for the period specified in the tender documents or to the Earnest Money while in their possession nor be liable to pay interest thereon.
- 3.5.6 If the tender is accepted, the amount of Earnest Money will be held as security deposit for due and faithful fulfillment of contract.
- 3.5.7 The tender are not accompanied by Earnest Money as mentioned in Para 3.5.1 of the tender document will be **summarily rejected**.
- 3.5.8 **For NSIC registered firm :**
- For Small Scale Units registered with NSIC/MSME (as mentioned in clause (x) of E-Tender notice) under single point registration scheme and participating in this tender, following exemptions shall be available
- They shall be exempted from cost of tender documents.
- 3.5.9 **Trade Receivables Discounting System (TReDS) for MSME:**
- "RailTel is registered with m1xchange TReDS Platform having Buyer registration Number "BUYER00001496". The URL for m1xchange Platform is <https://www.m1xchange.com>. MSE suppliers/vendors are required to register themselves on m1xchange Platform for availing the facility of bill discounting on TReDS portal. The bidder is mandatorily required to submit its TReDS registration number (as provided by M1xchange portal) and GRN (Goods/Service Receipt Note) Number (as provided by RailTel on delivery of Goods/Service) while submitting the invoices if requires to avail TReDS facility.
 - MSE Vendor will bear all costs relating to availing the facility of discounting on TReDS platform including but not limited to Registration charges, Transaction charges for financing, Discounting Charges, Interest on financing, or any other charges known by any name shall be borne by MSE Vendor

3. MSE Vendor hereby agrees to indemnify, hold harmless and keep RailTel and its affiliates, Directors, officers, representatives, agents and employees indemnified, from any and all damages, losses, claims and liabilities (including legal costs) which may arise from Sellers submission, posting or display, participation, in any manner, on the TReDS Platform or from the use of Services or from the Buyer's breach of any of the terms and conditions of the Usage Terms or of this Agreement and any Applicable Law on a full indemnity basis.
4. RailTel shall not be liable for any special, indirect, punitive, incidental or consequential damages or any damages whatsoever (including but not limited to damages for loss of profits or savings, business interruption, loss of information), whether in contract, tort, equity or otherwise or any other damages resulting from using TReDS platform for discounting their (MSE Vendor's) invoices.

3.6 SUBMISSION OF OFFERS

- 3.6.1 All offers in the prescribed forms should be submitted online before the time and date fixed. Offers submitted after the stipulated time and date will be summarily rejected.
- 3.6.2 In case the date of opening happens to be a holiday, the tender will be opened at the same time on the next working day.
- 3.6.3 All offers shall be either type written or written neatly in indelible ink in English. Each page of the offer must be numbered consecutively. A reference to total number of pages comprising the offer must be made at the top right hand corner of the top page. The supporting documents should be submitted either in original or duly signed by the authorized signatory of the tenderer. The original documents shall be produced for verification when called for.
- 3.6.4 **Quote in Figures and Words**
The tenderer is advised to quote percentage rate above/below/at Par of the RailTel's total estimated cost for SOR. Tenderer should give only one option. In case he gives more than one option, the offer will be summarily rejected.
- 3.6.5 **Attestation of alterations**
No scribbling is permissible in the tender documents. Tender containing erasures and alterations in the tender documents are liable to be rejected. Any correction made by the tenderer/ tenderers in his/their entries must be signed (not initialled) by him/them.
- 3.6.6 The tenderer shall submit his tender online. The offer shall consist of the following :-
The tender documents down loaded from web site shall be submitted with each page duly signed and stamped along with digital signature class-III.
 - i) Offer letter complete. (Form No.1) (i.e., Schedule of Requirements without rate quote)
 - ii) Earnest Money in prescribed form. (Para 3.5 of tender document)
 - iii) Constitution of Firm and Power of Attorney (in case of partnership firm).
 - iv) Clause wise compliance to tender conditions by signing of each page of tender document & statement of deviations .(Form No.5)
 - v) Any other information desired to be submitted by the tenderer.
 - vi) Registration with labor commissioner
 - vii) GST registration number.
 - viii) Affidavit as per Form -15

Note: The rate quoted in the offer by the contractor shall be inclusive of all the relevant factors taken into consideration and these should be firm and without any variation clauses.

3.7 CONSTITUTION OF FIRM AND POWER OF ATTORNEY

3.7.1 Any individual(s) signing the tender or other documents connected therewith should specify whether he is signing:-

- (a) As sole proprietor of the concern or as attorney of the sole proprietor;
- (b) As a partner or partners of the firm;
- (c) As a Director, Manager or Secretary in the case of Limited Company duly authorized by a resolution passed by the Board of Directors or in pursuance of the authority conferred by Memorandum of Association.

3.7.2 In the case of a firm not registered under the Indian Partnership Act, all the partners or the attorney duly authorized by all of them should sign the tender and all other connected documents. The original Power of Attorney or other documents empowering the individual or individuals to sign should be furnished to the Purchaser for verification, if required.

3.7.3 The RailTel will not be bound by Power of Attorney granted by the tenderer or by the changes in the composition of the firm made subsequent to the execution of the contract agreement.

3.7.4 In case where the Power of Attorney partnership deed has not been executed in English, the true and authenticated copies of the translation of the same by Advocate, authorized translators of Courts and Licensed Petition Writers should be supplied by the Contractor(s) while tendering for the work.

3.7.5 The duly notarized Power of Attorney, Partnership Deed, Memorandum of Joint Venture as the case may be in original or duly signed.

3.7.6 Participation Of Joint Venture (JV) Firms In Works Tender :

1. Separate identity/name shall be given to the Joint Venture.
2. Number of members in a JV shall not be more than three, if the work involves only one aspect and shall not be more than five, if the work involves more than one aspect. One of the members of the JV shall be its Lead Member who shall have a majority (at least 51%) share of interest in the JV. The other members shall have a share of not less than 20% each in case of JV with upto three members and not less than 10% each in case of JV with more than three members. In case of JV with foreign member(s), the Lead Member has to be an Indian firm/company with a minimum share of 51%.
3. A member of JV shall not be permitted to participate either in individual capacity or as a member of another JV in the same tender.
4. The tender form shall be purchased and submitted only in the name of the JV and not in the name of any constituent member. The tender form can however be submitted by JV or any of its constituent member or any person authorized by JV through Power of Attorney to submit tender.
5. Earnest Money Deposit (EMD) shall be deposited by JV or authorized person of JV through e-payment gateway or as mentioned in tender document.

6. A copy of Memorandum of Understanding (MoU) duly executed by the JV members on a stamp paper, shall be submitted by the JV along with the tender. The complete details of the members of the JV, their share and responsibility in the JV etc. particularly with reference to financial, technical and other obligations shall be furnished in the MoU. (The MoU format for this purpose shall be finalized by the RailTel in consultation with the Law Branch and shall be enclosed along with the tender).
7. Once the tender is submitted, the MoU shall not be modified / altered / terminated during the validity of the tender. In case the tenderer fails to observe/comply with this stipulation, the full Earnest Money Deposit (EMD) shall be liable to be forfeited.
8. Approval for change of constitution of JV shall be at the sole discretion of the RailTel. The constitution of the JV shall not be allowed to be modified after submission of the tender bid by the JV, except when modification becomes inevitable due to succession laws etc., provided further that there is no change in qualification of minimum eligibility criteria by JV after change of composition. However, the Lead Member shall continue to be the Lead Member of the JV. Failure to observe this requirement would render the offer invalid.
9. Similarly, after the contract is awarded, the constitution of JV shall not be allowed to be altered during the currency of contract except when modification become inevitable due to succession laws etc. and minimum eligibility criteria should not get vitiated. Failure to observe this stipulation shall be deemed to be breach of contract with all consequential penal action as per contract conditions.
10. On award of contract to a JV, a single Performance Guarantee shall be submitted by the JV as per tender conditions. All the Guarantees like Performance Guarantee, Bank Guarantee for Mobilization Advance, Machinery Advance etc. shall be accepted only in the name of the JV and no splitting of guarantees amongst the members of the JV shall be permitted.
11. On issue of LOA (Letter of Acceptance), the JV entity to whom the work has been awarded, with the same shareholding pattern as was declared in the MOU/JV Agreement submitted along with the tender, shall be got registered before the Registrar of the Companies under 'The Companies Act -2013' (in case of Company) or before the Registrar/Sub-Registrar under the 'The Indian Partnership Act, 1932' (in case of Partnership Firm) or under 'The LLP Act 2008' (in case of LLP). A separate PAN shall be obtained for this entity. The documents pertaining to this entity including its PAN shall be furnished to the RailTel before signing the contract agreement for the contract. In case the tenderer fails to observe/comply with this stipulation within 60 days of issue of LOA, contract is liable to be terminated. In case contract is terminated RailTel shall be entitled to forfeit the full amount of the Earnest Money Deposit and other dues payable to the Contractor under this contract. The entity so registered, in the registered documents, shall have, inter-alia, following Clauses:
 - a) Joint And Several Liability - Members of the entity to which the contract is awarded, shall be jointly and severally liable to the RailTel for execution of the project in accordance with General and Special Conditions of Contract. The members of the entity shall also be liable jointly and severally for the loss, damages caused to the RailTel during the course of execution of the contract or due to non-execution of the contract or part thereof.
 - b) Duration of the Registered Entity - It shall be valid during the entire currency of the contract including the period of extension, if any and the maintenance period after the work is completed.
 - c) Governing Laws - The Registered Entity shall in all respect be governed by and interpreted in accordance with Indian Laws.

12. Authorized Member - Joint Venture members in the JV MoU shall authorize one of the members on behalf of the Joint Venture to deal with the tender, sign the agreement or enter into contract in respect of the said tender, to receive payment, to witness joint measurement of work done, to sign measurement books and similar such action in respect of the said tender/contract. All notices/correspondences with respect to the contract would be sent only to this authorized member of the JV.
13. No member of the Joint Venture shall have the right to assign or transfer the interest right or liability in the contract without the written consent of the other members and that of the RailTel in respect of the said tender/contract.
14. Documents to be enclosed by the JV along with the tender:
 - a) In case one or more of the members of the JV is/are partnership firm(s), following documents shall be submitted:
 - i) A notarized copy of the Partnership Deed,
 - ii) A copy of consent of all the partners or individual authorized by partnership firm, to enter into the Joint Venture Agreement on a stamp paper,
 - iii) A notarized or registered copy of Power of Attorney in favour of the individual to sign the MOU/JV Agreement on behalf of the partnership firm and create liability against the firm.
 - b) In case one or more members is/are HUF, the following documents shall be enclosed:
 - i) A copy of notarized affidavit on Stamp Paper declaring that he who is signing the affidavit on behalf of HUF is in the position of „Karta“ of Hindu Undivided Family (HUF) and he has the authority, power and consent given by other members to act on behalf of HUF.
 - c) In case one or more members of the JV is/are companies, the following documents shall be submitted:
 - i) A copy of resolutions of the Directors of the Company, permitting the company to enter into a JV agreement,
 - ii) The copies of MOA (Memorandum of Association) / AOA (Articles of Association) of the company
 - iii) A copy of Certificate of Incorporation
 - iv) A copy of Authorization/copy of Power of Attorney issued by the Company (backed by the resolution of Board of Directors) in favour of the individual to sign the tender, sign MOU/JV Agreement on behalf of the company and create liability against the company
 - d) All the Members of JV shall certify that they are not blacklisted or debarred by RailTel or Railways or any other Ministry / Department of the Govt. of India from participation in tenders/contract on the date of opening of bids either in their individual capacity or as a member of the JV in which they were/are members.
 - e) Credentials & Qualifying Criteria: Technical, financial eligibility and Bid capacity of the JV shall be adjudged based on satisfactory fulfilment of the following criteria:

- i) Technical Eligibility Criteria:
Either the JV Firm or Lead Member of the JV Firm must comply clause 3.16.2 of Chapter-3.
- ii) Financial Eligibility Criteria:
Either the JV Firm or Lead Member of the JV Firm must comply clause 3.16.3 of Chapter-3.

Appendix-1

Memorandum of Understanding (MOU) for Joint Venture Participation

(To be executed on non-judicial stamp paper of appropriate value in accordance with relevant stamp Act. The stamp paper to be in the name of the company who is issuing the Power of Attorney).

JOINT VENTURE PARTICIPATION BETWEEN

M/s.....having its registered office at (here after referred to as.....) acting as the Lead Partner of the first part and

M/s.....having its registered office at(hereafter referred to as ‘.....’) in the capacity of a Joint Partner of the other part.
(If more than two partners include the details accordingly).

Now all the parties i.e. _____ and _____ will be known as M/s _____ (JV).

The expressions ofandshall whatever the context admits, mean and include their respective legal representatives, successors-in-interest and assigns and shall collectively be referred to as “the Parties” and individually as “the Party”

WHEREAS; **RailTel Corporation Of India Ltd.** (hereinafter referred to as “RailTel”) has invited bids for(insert name of work)
.....

NOW, THEREFORE, THE PARTIES AGREE AS FOLLOWS:

1. The ‘Parties’ have studied the documents and have agreed to submit their bid as Joint Venture (JV).

2. M/s.....shall be the lead member of the JV for all intents and purpose and shall represent the Joint Venture in its dealing with the RailTel. For the purpose of submission of Tender proposals, the parties agree to nominate M/sas the leader duly authorized to sign and submit all documents and subsequent clarifications, if any, to the RailTel.

3. The ‘Parties’ have resolved that the distribution of share and responsibilities is as under:

a) Lead Partner share%;
Responsibilities.

i)

ii)

iii)

(Technical, Financial & other obligations)

b) Other Joint Venture Partner's share -----%
Name
Responsibilities. i)
(Technical, Financial & other obligations) ii)
iii)

c) Other Joint Venture Partner's share -----%
Name
Responsibilities. i)
(Technical, Financial & other obligations) ii)
iii)

4. JOINT AND SEVERAL RESPONSIBILITY

The Parties undertake that they shall be jointly and severally liable to the RailTel for execution of the Project in accordance with General and Special Conditions of Contract. The JV members shall also be liable jointly and severally for the loss, damages caused to the RailTel during the course of execution of the contract or due to non-execution of the contract or part thereof.

5. ASSIGNMENT AND THIRD PARTIES

No member of the Joint Venture firm shall have the right to assign or transfer the interest, right or liability in the contract without the written consent of the other members and that of the RailTel in respect of the said tender/contract.

6. EXECUTIVE AUTHORITY

Joint Venture members shall authorize one of the members on behalf of the Joint Venture Firm to deal with the tender, sign the agreement or enter into contract in respect of the said tender, to witness joint measurement of work done, to sign measurement books and similar such action in respect of the said tender/contract. All notices/correspondences with respect to the contract would be sent only to this authorized member of the JV firm.

Any Payment shall be released to the Joint Venture and not to the one member and accordingly Joint Venture shall have PAN of the Joint Venture firm.

7. VALIDITY

This MOU shall remain in force till the occurrence of the earliest of the following, unless by mutual consent, the parties agree in writing to extend the validity for a further period.

- a. Tender submitted by the joint venture is declared unsuccessful, or
- b. Cancellation/shelving of the project by the RailTel for any reasons prior to award of work.

In case, the Tender submitted by the joint venture is declared successful; the validity of this MOU shall be extended till the JV agreement is signed and got ratified.

8. This MOU is drawn innumber of copies with equal legal strength and status. One copy is held by M/s..... and the other by M/s. &.....M/s..... and a copy submitted with the proposal.

9. This MOU shall in all respects be governed by and interpreted in accordance with Indian Laws.

10. NOTICES

Notices shall be given in writing by Fax confirmed by registered mail or commercial courier to the following Fax numbers and addresses.

.....
.....

11. JV Agreement.

We are aware, that after issue of LOA by RailTel, an agreement among the members of the JV firm has to be executed and got registered before the Registrar of Companies under the Companies Act or with the Registrar/Sub-Registrar under the Registration Act. This agreement shall be submitted by the JV firm to RailTel before signing the contract agreement for the work. In case the JV partners fail to observe/comply with stipulations, the Earnest Money Deposit, deposited with the RailTel shall be forfeited and other penal actions due shall be taken against partners of the JV and the JV by the RailTel.

12. We shall furnish along with the tender requisite documents as mentioned under para 15.1, 15.2, 15.3 (as the case may be) of the guidelines of RailTel for participation of J.V. firms in works tender.

Declaration

It is to certify that we have not been black listed or debarred by the RailTel, Railways or any other ministry/departments of the Govt. of India/State Govt. from participation intenders/contract in the past either in our individual capacity or the J.V. firm or partnership firm in which we were members/partners.

Lead Partner

(Name and Address)

Other Partner(s).

(Name and Address)

Name and Address of the J.V. firm

IN WITNESS WHEREOF THE PARTIES, have executed this MOU the day, month and year first before written.

M/s.....

M/s.....

.....

(Seal)

(Seal)

Witness:

1. (Name & Address)

2. (Name & Address)

3.8 VALIDITY OF OFFER

The tenderer should keep the offers valid for the period as mentioned in Para 1.8 of tender document.

3.9 RATES DURING NEGOTIATION

The tenderer/s shall not increase his/their quoted rates in case the RailTel Administration negotiates for reduction of rates. Such negotiations shall not amount to cancellation or withdrawal of the original offer and the rates originally quoted will be binding on the tenderer/s.

3.10 PERIOD OF COMPLETION AND TIME PROGRESS GRAPH

The works/work are/is to be completed within a period as mentioned in Para 1.9 of the tender document from the date of issue of Letter of Acceptance of the tender.

3.11 OPENING OF TENDER

The tender will be opened at the time & date of the tender given in the Para 1.5, in the presence of such Tenderers/Authorized Representatives who choose to be present

3.12 NON-TRANSFERABILITY AND NON-REFUNDABILITY

The tender documents are not transferable. The cost of tender documents is not refundable.

3.13 ERRORS, OMISSIONS & DISCREPANCIES

The Contractor(s) shall not take any advantage of any mis-interpretation of the conditions due to typing or any other error and if in doubt, shall bring it to the notice of the Engineer without delay. In case of any contradiction only the printed rules, and books should be followed and no claim for the mis-interpretation shall be entertained.

3.14 WRONG INFORMATION BY TENDERER

If the tenderer/s deliberately gives/give wrong information in his/their tender which creates/create circumstances for the acceptance of his/their tender the RailTel reserves the right to reject such tender at any stage.

3.15 AMENDMENT OF BID DOCUMENTS:

3.15.1 At any time, prior to the date for submission of bids, the RAILTEL may, for any reason whether suo-moto or in response to clarification requested by a prospective Bidder, modify the bid documents by amendments.

3.15.2 The amendments shall be posted on website only. All bidders should download from website. These amendments will be binding on all bidders. Those who are downloading tender document from website should download the clarification also and submit with the tender document.

3.15.3 In order to afford prospective bidders reasonable time to take the amendments into account in preparing their bids, the RAILTEL may, at its discretion, extend the deadline for the submission/opening of bids suitably.

3.16 Qualifying Criteria :

3.16.1 General

For work amounting more than Rs.50 lakhs only:

3.16.1.1 The tenderer should submit the details of experience of similar works or services in the projects executed / under execution which should clearly bring out expertise in the work as per Form no. 13.

3.16.1.2 The tenderer/s must submit along with his/their tender, certificates from the original user for whom the project was undertaken, certifying the date of award of contract, date of completion, date of commissioning and the present working state of the system so established and contractual payments received till the date of submission of the tender. The tenderer shall submit these certificates for all the

projects that he has executed which only satisfy the minimum requirements in each case. The certificates are to be submitted in original or their true copies duly signed by the tenderer, preferably as per Form no. 2.

3.16.2 Technical Eligibility Criteria and meaning of Similar Single Work:

3.16.2.1 The tenderer must have successfully completed any of the following during last 07 (seven) years, ending last day of month previous to the one in which tender is invited:

a) Three similar works each costing not less than the amount equal to 30% of advertised value of the Tender.

OR

b) Two similar works each costing not less than the amount equal to 40% of advertised value of the Tender.

OR

c) One similar work each costing not less than the amount equal to 60% of advertised value of the Tender.

3.16.2.2 The technical eligibility for the contract as per para 3.16.2.1 above, shall be satisfied by either the 'JV in its own name & style' or 'any member having min 26% share'. Each other member of JV shall have technical capacity of minimum 10% of the cost of work i.e., each JV member must have satisfactorily completed during the last 07 (seven) years, ending last day of month previous to the one in which tender is invited, one similar single work for a minimum of 10% of advertised value of the tender.

3.16.2.3 Definition of similar single work is as under-

Works similar to the scope of work as contained in this tender shall mean

i) All type of Telecom equipment/OFC including telecom cable works, OFC maintenance works.

OR

ii) Any type of Railway Signaling works etc.

OR

iii) Any type of Electrical works/Transmission Line works etc.

OR

iv) Civil engineering works like road construction, building construction works, pipe laying works (Gas, Sewer etc.) or similar civil works.

The work should have been executed for Govt./PSUs/Telecom Service Providers/Infrastructure Providers

3.16.3 Financial Eligibility Criteria:

3.16.3.1 The tenderer must have received contractual payments in the previous three financial years and the current financial year up to the date of inviting of tender, at least 150% of advertised value of the Tender.. The tenderers shall submit Certificates to this effect which may be an attested Certificate from the concerned department / client or Audited Balance Sheet duly certified by the Chartered Accountant/Certificate from Chartered Accountant duly supported by Audited Balance Sheet.

(Note: Client certificate from other than Govt. Organization should be duly supported by Form 16A/26AS generated through TRACES of Income Tax Department of India).

3.16.3.2 The JV shall satisfy the requirement of “Financial Eligibility” mentioned at para 3.16.3 (i) above. The “financial capacity” of the lead partner of JV shall not be less than 51% of the financial eligibility criteria mentioned at para 3.16.3 (i) above. The arithmetic sum of individual “financial capacity” of all the members shall be taken as JV’s “financial capacity” to satisfy this requirement.

(Note: Contractual payment received by a Member in an earlier JV shall be reckoned only to the extent of the concerned member’s share in that JV for the purpose of satisfying compliance of the above-mentioned financial eligibility criteria in the tender under consideration).

3.16.4 Engineering Organization

The tenderer shall depute required number of Engineers and experienced supervisors at the given site of work for planning, supervision and execution of the work. The qualification and experience of these proposed personnel should be enclosed along with the bid.

3.16.5 Construction and Maintenance Machinery

For work amounting more than Rs.50 lakhs: The tenderer should furnish the details of the machinery and plants to be deployed, in case the tenderer plans to use mechanized trenching.

3.17 EVALUATION OF OFFER.

3.17.1 The authority for the acceptance of the tender rests with the Purchaser. The tenders received will be evaluated by the Purchaser to ascertain the best acceptable tender in the interest of the Purchaser.

3.17.2 However, the purchaser shall not be bound to accept the lowest or any tender. The purchaser reserves the right to accept any tender in respect of the whole or any portion of the work specified in the tender paper or to sub-divide the work among different Tenderers or to reduce the work or to accept any tender for less than the tendered quantities.

Inter se position of the offers will be determined on the basis of total cost on destination basis, which will include basic rate, custom duty, CGST, SGST, IGST, GST, labour cess, freight, insurance and any other charges or cost quoted by the tenderer, including GST payable.

3.18 AGREEMENT

The successful tenderer/s shall be required to execute an agreement with RailTel for carrying out the work as per the tender document.

3.19 TENDERER’S ADDRESS

Tenderer shall state in the tender his postal address with PIN, Telephone No., Fax No. email id if any, fully and clearly. Any communication sent to the tenderers by post at his said address shall be deemed to have reached the tenderer duly & timely, notwithstanding the fact that the communication could not reach the tenderer at all or in time for whatever reason. Important documents shall be sent by Registered Post/Courier.

CHAPTER - 4

GENERAL CONDITIONS OF CONTRACT

Para	Subject
4.1	Definitions
4.2	General Obligations
4.3	Law governing the Contract
4.4	Communications to be in writing
4.5	Service of Notice on Contractors
4.6	Occupation and use of land
4.7	Assignment or Subletting of Contract
4.8	Assistance by the RailTel for the stores to be obtained by the Contractor
4.9	Railway Passes
4.10	Carriage of Materials
4.11	Force Majeure Clause
4.12	Representation of Works
4.13	Relics and Treasures
4.14	Excavated Material
4.15	Indemnity by Contractors
4.16	Security Deposit
4.17	Completion Period
4.18	Illegal Gratification
4.19	Execution of Works
4.20	Compliance to Engineer's Instructions
4.21	Instructions of Engineer's Representative
4.22	Adherence to specifications and Drawings
4.23	Working During Night
4.24	Damage to Govt./RailTel Property or Private Life and Property
4.25	Sheds, Store houses and Yards
4.26	Provision of efficient and competent staff
4.27	Workmanship and Testing
4.28	Facilities for Inspection
4.29	Examination of work before covering up
4.30	Temporary Works
4.31	Contractor to supply water for works
4.32	Property in material and Plants
4.33	Tools, Plant and Materials supplied by RailTel
4.34	Precaution during progress of work
4.35	Use of Explosives
4.36	Suspension of Works
4.37	Rates for items of works
4.38	Demurrage and wharfage dues
4.39	Rates for extra items of works
4.40	Handing over of works
4.41	Variations in extent of contract
4.42	Powers of modification to contract
4.43	Claims

- 4.44 Measurements, certificates and payments
- 4.45 Measurement of Works
- 4.46 “On-Account” Payments
- 4.47 Maintenance of Works
- 4.48 Certificate of Completion of works
- 4.49 Approval only by Final Acceptance Certificate (FAC)
- 4.50 Final Acceptance Certificate.
- 4.51 Final Payment
- 4.52 Withholding and lien in respect of sums claimed
- 4.53 Signature on receipts for amounts
- 4.54 Labour
- 4.55 Provisions of Payment of Wages Act
- 4.56 Reporting of Accidents to Labour
- 4.57 Provisions of Workmen’s Compensation Act
- 4.58 RailTel not to provide quarters for Contractor
- 4.59 Labour Camps
- 4.60 Non-employment of Labourers below the age of 15
- 4.61 Determination of Contract
- 4.62 Termination of Contract owing to default of Contractor
- 4.63 Matters finally determined by RailTel
- 4.64 Settlement of dispute and arbitration

रेलटेल
RAILTEL

A Government of India
Undertaking

GENERAL CONDITIONS OF CONTRACT

DEFINITIONS AND INTERPRETATION

4.1 Definitions:

4.1.1 The meaning of terms/interpretations shall be taken as defined in Chapter- 3, (INSTRUCTIONS TO TENDERERS AND CONDITIONS OF TENDERING).

4.2 General Obligations

4.2.1 Execution Co-relation and intent of contract documents: The contract documents shall be signed in triplicate by the RailTel and the Contractor. The contract documents are complementary, and what is called for by any one shall be as binding as if called for all; the intention of the documents is to include all labour and materials, equipments and transportation necessary for the proper execution of work. Materials or work not covered by or properly inferable from any heading or class of the specifications shall not be supplied by the RailTel to the contractors unless distinctly specified in the contract documents. Materials or works described in words, which so applied, have a well-known technical or trade meaning shall be held to refer to such recognized standards.

4.2.2 If a work is transferred from the jurisdiction of one region of RailTel to another region or to a Project authority or vice versa while the contract is in subsistence, the contract shall be binding on the Contractor and the other region in the same manner & take effect in all respects as if the Contractor and the other region were parties thereto from the inception and the corresponding officer or the competent authority in the other region will exercise the same powers and enjoy the same authority as conferred to the Predecessor RailTel/Project under the original contract/agreement entered into.

4.2.3 If for administrative or other reasons the contract is transferred to the other region of RailTel the contract shall notwithstanding anything contained herein contrary thereto, be binding on the Contractor and the other region in the same manner and take effect in all respects as if the contractor and the other region had been parties thereto from the date of this contract.

4.3 Law governing the contract

4.3.1 The Contract shall be governed by the law for the time being in force in the Republic of India.

4.3.2 Compliance to regulations and by-laws – The Contractor shall conform to the provision of any statute relating to the works and regulations and bye-laws of any local authority and of any water and lighting companies or undertakings, with whose system the work is proposed to be connected and shall before making any variation from the drawings or the specifications that may be necessitated by so confirming give to the Engineer notice specifying the variation proposed to be made and the reason for making the variation and shall not carry out such variation until he has received instructions from the Engineer in respect thereof. The Contractor shall be bound to give all notices required by statute, regulations or by-laws as aforesaid and to pay all fees and taxes payable to any authority in respect thereof.

4.4 **Communications to be in writing** – All notices, communications, references and complaints made by the RailTel or the Engineer or the Engineer's representative or the Contractor interest concerning the works shall be in writing and no notice, communication, references or complaint not in writing shall be recognized.

- 4.5 Service of Notices on Contractors** – The Contractor shall furnish to the Executive Director/RailTel the name, designation and address of his authorized agent and all complaints, notices, communications and references shall be deemed to have been duly given to the contract if delivered to the Contractor or his authorized agent or left at or posted to the address so given and shall be deemed to have been so given in the case of posting on day on which they would have reached such address in the ordinary course of post or on the day on which they were so delivered or left. In the case of contract by partners, any change in the constitution of the firm shall be forthwith notified by contractor to the Executive Director/RailTel.
- 4.6 Occupation and use of land** – No land belonging to or in the possession of the Railway/RailTel shall be occupied by the contractor without the permission of the RailTel. The Contractor shall not use, or allow to be used; the site for any purposes other than that of executing the works.
- 4.7 Assignment or subletting of contract** - The Contractor shall not assign or sublet the contract or any part thereof or allow any person to become interested therein in any manner whatsoever without the special permission in writing of the RailTel. Any breach of this condition shall entitle the RailTel to rescind the contract under Para 4.62 of these conditions and also render the contractor liable for payment to the RailTel in respect of any loss or damage arising or ensuring from such cancellation. Provided always that execution of the details of the work by petty contractor under the direct and personal supervision of the contractor or his agent shall not be deemed to be sub-letting under this clause. The permitted subletting of work by the contractor shall not establish any contractual relationship between the sub-contractor and the RailTel and shall not relieve the Contractor of any responsibility under the Contract.
- 4.8 Assistance by the RailTel for the stores to be obtained by the Contractor-**
Owing to difficulty in obtaining certain materials (including Tools & Plants) in the market, the RailTel may have agreed without any liability therefore, to endeavor to obtain or assist the Contractor in obtaining the required quantities of such materials as may be specified in the Tender. In the event of delay or failure in obtaining the required quantities of the aforesaid materials, the Contractor shall not be deemed absolved of his own responsibility and shall keep in touch with the day-to-day position regarding their availability and accordingly adjust progress of works including employment of labour and the RailTel shall not in any way be liable for the supply of materials or for the non-supply thereof for any reasons whatsoever not for any loss or damage arising in consequence of such delay or non-supply.
- 4.9 Railway Passes** – No free Railway passes shall be issued by the RailTel to the Contractor or any of his employee/worker.
- 4.10 Carriage of materials** – No forwarding orders shall be issued by the RailTel for the conveyance of Contractor's materials, tools and plant by Rail which may be required for use in the works and the contractor shall pay full freight at public tariff rates therefore.
- 4.11 Force Majeure Clause** -If at any time, during the continuance of this Contract, the performance, in whole or part, by either party, of any obligation under this contract shall be prevented or delayed by reason of any war, hostility, act of the public enemy, Civil Commotion, Sabotage, Fires, Floods, Earth quakes, explosions, strikes, epidemics,

quarantine restrictions, lockouts, any statute, statutory rules/ regulations, order of requisitions issued by any Government Department or Competent Authority of acts of God (here-in-after referred to as event) then provided notice of the happening of any such event is given by either party to the other within twenty one days from the date of occurrence thereof, neither party shall, by reason of such event, be entitled to terminate this Contract nor shall either party have any claim for damage against the other in respect of such non- performance or delay in performance, and the obligations under the Contract shall be resumed as soon as practicable after such event has come to an end or ceased to exist, provided further that if the performance in whole or part of any obligation under this Contract is prevented or delayed by reason of any such event beyond a period as mutually agreed to by the RailTel and the Contractor after any event or 60 days in the absence of such an agreement whichever is more, either party may at its option terminate the Contract provided also that if the contract is so terminated under this clause the RailTel may at the time of such termination take over from the Contractor at prices as provided for in the contract, all works executed or works under execution.

- 4.12 Representation on Works** – The Contractor shall, when he is not personally present on the site of the works place, keep a responsible agent at the works during working hours who shall, on receiving reasonable notice, present himself to the Executive Director/RailTel and orders given by the Engineer or the Engineer's Representative to the agent shall be deemed to have the same force as if they had been given to the Contractor. Before absenting himself, the Contractor shall furnish the name and address of his agent for the purpose of this clause and failure on the part of the Contractor to comply with this provision at any time will entitle the RailTel to rescind the contract under Para 4.62 of these conditions.
- 4.13 Relics and Treasures** – All gold, silver, oil and other minerals of any description and all precious stones, coins, treasures, relics, antiquities and other similar things which shall be found in or upon the site shall be property of the RailTel and the Contractor shall duly preserve the same to the satisfaction of the RailTel and shall from time to time deliver the same to such person or persons as the RailTel may appoint to receive the same.
- 4.14 Excavated material** – The Contractor shall not sell or otherwise dispose of or remove except for the purpose of this contract, the sand, stone, clay ballast, earth, rock or other substances or materials which may be obtained from any excavation made for the purpose of the works or any building or produced upon the site at the time of delivery of the possession thereof but all the substances, materials, buildings, and produce shall be the property of the RailTel provided that the Contractor may, with the permission of the Executive Director/RailTel, use the same for the purpose of the works either free of cost or pay the cost of the same at such rates as may be determined by the Engineer.
- 4.15 Indemnity by Contractors** – The Contract shall indemnify and save harmless the RailTel from and against all actions, suit proceedings, losses, costs, damages, charges, claims, and demands of every nature and description brought or recovered against the RailTel by reason of any act or omission of the Contractor, his agents or employees, in the execution of the works or in his guarding of the same. All sums payable by way of compensation under any of these conditions shall be considered as reasonable compensation to be applied to the actual loss or damage sustained, and whether or not any damage shall have been sustained.

4.16 Security Deposit

4.16.1 The Earnest Money deposited by the Contractor with his tender will be retained by the RailTel as part of security for the due and faithful fulfillment of the contract by the contractor. The balance to make up the security deposit, the rates for which are given below, shall be recovered by percentage deduction from the Contractor's "on account" bills.

- (a) Unless otherwise specified in the special conditions, if any, the Security Deposit/rate of recovery/mode of recovery shall be as under:-
- (i) Security Deposit for each work should be 5% of the contract value.
 - (ii) The rate of recovery shall be at the rate of 10% of the bill amount till the full security deposit is recovered.
 - (iii) Security Deposits will be recovered only from the running bills of the contract and no other mode of collecting SD such as SD in the form of instruments like BG, FD etc. shall be accepted towards Security Deposit.
- (b) Refund of SD –The Security Deposit for execution of work shall be released after a period of 12 months commencing immediately after commissioning of the project and issue of last Provisional Acceptance Certificate, which will be enforceable by RailTel, and issue of the certificate of final acceptance of entire system specified in the tender and submission of PBG for the maintenance obligations, provided that all the stipulations of the clause have been fulfilled by the Contractor and all claim and demands made against the RailTel for and in respect of damage or loss by, from or in consequence of the works have been finally satisfied, provided further that in the event of different maintenance periods having become applicable to different parts of the works pursuant to Para 4.48.1 of these condition, the expression "expiration of the period of warranty" shall for the purpose of this clause, be deemed to mean the expiry of the latest of such periods. The security deposit shall be released only after the expiry of the maintenance period and after passing the final bill based on "No Claim Certificate".

It has now been decided that:

- i) After the work is physically completed, security deposit recovered from the running bills of a contractor can be returned to him if he so desires, in lieu of irrevocable Bank Guarantee for equivalent amount to be submitted by him.
 - ii) In case of contracts of value Rs. 50 crore and above, irrevocable Bank Guarantee can also be accepted as a mode of obtaining security deposit.
- (c) No interest will be payable upon the Earnest Money and Security Deposit or amount payable to the Contractor under the Contract.
- (d) Should the tenderer fail to observe or comply with the foregoing stipulation the amount deposited as security for the due performance of the above stipulation shall be forfeited by the RailTel.

4.16.2 INTRODUCTION OF PERFORMANCE GUARANTEES (P.G.):

The procedure for obtaining Performance Guarantee is outlined below:-

- (a) The successful bidder shall have to submit a Performance Guarantee (PG) within 21 (Twenty one) days from the date of issue of Letter of Acceptance (LOA). Extension of time for submission of PG beyond 21 (Twenty one) days and upto 60 days from the date

of issue of LOA may be given by the Authority who is competent to sign the contract agreement. However, a penal interest of 12% per annum shall be charged for the delay beyond 21(Twenty one) days, i.e. from 22nd day after the date of issue of LOA. Further, if the 60th day happens to be a declared holiday in the concerned office of the RailTel, submission of PG can be accepted on the next working day.

In all other cases, if the Contractor fails to submit the requisite PG even after 60 days from the date of issue of LOA, the contract is liable to be terminated. In case contract is terminated railway shall be entitled to forfeit Earnest Money Deposit and other dues payable against that contract.

- (b) The successful bidder shall submit the Performance Guarantee amounting to 5% of the contract value in the form of Irrevocable Bank Guarantee from scheduled bank. For performance security of up to Rs. 5 lacs, please refer para 1.13
- (c) The Performance Guarantee should be submitted by the successful bidder after the Letter of Acceptance (LOA) has been issued, but before signing of the contract agreement. The P.G. shall be initially valid up to the stipulated date of completion plus 60 days beyond that. In case, the time for completion of work gets extended, the contractor shall get the validity of Performance Guarantee extended to cover such extended time, for completion of work plus 60 days.
- (d) The value of PBG to be submitted by the contractor will not change for variation up to 25% (either increase or decrease). In case during the course of execution, value of the contract increases by more than 25% of the original contract value, an additional Performance Guarantee amounting to 5%(Five percent) for excess value over the original contract value shall be deposited by the contractor.
- (e) The Performance Bank Guarantee (PBG) shall be released after the physical completion of the work based on the Last Provisional Acceptance Certificate issued by the competent authority stating that the contractor has completed the work in all respects satisfactorily. The Security Deposit shall, however, be released only after expiry of the maintenance period and issue of the certificate of final acceptance of entire system specified in the contract and after passing the final bill based on 'No Claim Certificate' from the contractor.
- (f) Whenever the contract is rescinded, the security deposit shall be forfeited and the Performance Bank Guarantee shall be en-cashed the balance work shall be got done independently without risk and cost of the failed contractor. The failed contractor shall be debarred from participating in the tender for executing the balance work. If the failed contractor is a JV or partnership firm, then every member or partner of such a firm shall be debarred from participating in the tender for the balance work either in his/her individual capacity or as a partner of any other JV/Partnership firm.
- (g) The Engineer shall not make a claim under the Performance Bank Guarantee except for amounts to which the RailTel's entitled under the contract (Notwithstanding, and /or without prejudice to any other provisions in the contract agreement) in the event of:
 - (i) Failure by the contractor to extend the validity of the Performance Bank Guarantee as described herein above, in which event the Engineer may claim the full amount of the Performance Bank Guarantee.
 - (ii) Failure by the contractor to pay RailTel any amount due either as agreed by the contractor or determined under any of the clauses/conditions of the agreement, within thirty days of the service of the notice to this effect by Engineer.
 - (iii) The contract being determined or rescinded, the Performance Bank Guarantee shall be forfeited in full and shall be absolutely at the disposal of the RailTel Corporation of India Ltd.

NOTE : “ A separate advice of the BG will invariably be sent by the BG issuing bank to the RailTel’s Bank through SFMS(Structured Financial Messaging System) and only after this the BG will become acceptable to RailTel. It is therefore in own interest of bidder to obtain RailTel’s bank IFSC code, its branch and address and advise these particulars to the BG issuing bank and request them to send advise of BG through SFMS to the RailTel’s bank.

The RailTel’s bank details are as under :

Account No. : 317801010036605.

A/c Name : RailTel WR collection A/c.

Bank Name : Union Bank of India.

Branch Name : Mahalaxmi branch.

Branch Address : 22, Bhulabhai Desai Road, Mahalaxmi chambers,
Mahalaxmi, Mumbai-400026.

IFSC Code : UBIN0531782.

Swift Code : UBININBBLOP.

4.17 Completion Period – As given in e-Tender Notice

4.17.1 Subject to any requirement in the contract as to completion of any portion or portions of the works before completion of the whole, the contractor shall fully and finally complete the whole of the works comprised in the contract (with such modifications as may be directed under conditions of this contract) by the date entered in the contract or extended date in terms of the following clauses:

4.17.1.1 If any modifications have been ordered which in the opinion of the Engineer have materially increased the magnitude of the work, then such extension of the contracted date of completion may be granted as shall appear to the Engineer to be reasonable in the circumstances, provided moreover that the Contractor shall be responsible for requesting such extension of the date as may be considered necessary as soon as the clause thereof shall arise and in any case not less than one month before the expiry of the date fixed for completion of the works.

4.17.1.2 If in the opinion of the Engineer the progress of work has any time been delayed by any act or neglect of RailTel’s employees or by other contractor employed by the RailTel under Para 4.20.4 of these conditions or in executing the work not forming part of the contract but on which contractor’s performance necessarily depends or by reason of proceeding taken or threat-tended by or dispute with adjoining or neighboring owners or public authority arising otherwise through the Contractor’s own default etc. or by the delay authorized by the Engineer pending arbitration or in consequences of the contractor not having received in due time necessary instructions from the RailTel for which he shall have specially applied in writing to the Engineer or his authorized representative then, upon happening of any such event causing delay, the contractor shall immediately give notice thereof in writing to the Engineer within 15 days of such happening but shall nevertheless make constantly his best endeavors to bring down or make good the delay and shall do all that may be reasonably required of him to the satisfaction of the Engineer to proceed with the works. The contractor may also indicate the period for which the work is likely to be delayed and shall be bound to ask for necessary extension of time. The engineer on receipt of such request from the contractor shall consider the same and shall grant such extension of time as in

his opinion is reasonable having regard to the nature and period of delay and the type and quantum of work affected thereby. No other compensation shall be payable for works so carried forward to the extended period of time, the same rates, terms and conditions of contract being applicable as if such extended period of time was originally in the original contract itself.

- 4.17.1.3 In the event of any failure or delay by the RailTel to hand over the Contractor possession of the lands necessary for the execution of the works or to give the necessary notice to commence the works or to provide the necessary drawings or instructions or any other delay caused by the RailTel due to any other cause whatsoever, then such failure or delay shall in no way affect or vitiate the contract or alter the character thereof or entitle the contractor to damages or compensation therefore but in any such case, the RailTel may grant such extension or extensions of the completion date as may be considered reasonable.
- 4.17.2 Extension of time for delay due to contractor – The time for the execution of the work or part of the works specified in the contract documents shall be deemed to be the essence of the contract. If the contractor fails to complete the works within the time as specified in the contract for the reasons other than the reasons specified in clause 4.11 and 4.17.1 above, the RailTel may, if satisfied that the works can be completed by the contractor within reasonable short time thereafter, allow the contractor further extension of time as the Engineer may decide. On such extension the RailTel will be entitled without prejudice to any other right and remedy available on that behalf, to recover from the contractor as agreed damages and not by way of penalty as mentioned in para 5.35.1 of special conditions of contract.
- 4.17.2.1 For the purpose of this clause, the contract value of the works shall be taken as value of work as per contract agreement including any supplementary work order/contract agreement issued. Provided also, that the total amount of liquidated damages under this condition shall be as per para 5.35.1 of special conditions of contract. Provided further, that if the RailTel is not satisfied that the works can be completed by the Contractor and in the event of failure on the part of the contractor to complete the work within further extension of time allowed as aforesaid, the RailTel shall be entitled, without prejudice to any other right or remedy available in that behalf, to appropriate the contractor's security deposit and rescind the contract under clause 4.62 of these conditions, whether or not actual damage is caused by such default..

4.18 Illegal Gratification

- 4.18.1 Any bribe, commission, gift or advantage given, promised or offered by or on behalf to the Contractor or his partner, agent or servant or anyone on his behalf, to any officer or employees of the RailTel, or to any person on his behalf in relation to obtaining or the execution of this or any other contract with the RailTel shall, in addition to any criminal liability which he may incur, subject the contractor to the rescission of the contract and all other contracts with the RailTel and to the payment of any loss or damage resulting from such decision and the RailTel shall be entitled to deduct the amounts so payable from any moneys due to the Contractor (s) under this contract or any other contracts with the RailTel.
- 4.18.2 The Contractor shall not lend or borrow from or have or enter into any monetary dealings or transactions either directly or indirectly with any employee of the RailTel and if he shall do so, the RailTel shall be entitled forthwith to rescind the contract an

all other contracts with the RailTel. Any question or dispute as to the commission or any shall offence or compensation payable to the RailTel under this clause shall be settled by the Executive Director of RailTel, in such a manner as shall consider fit and sufficient and his decision shall be final and conclusive. In the event of rescission of the contract under this clause, the Contractor will not be paid any compensation whatsoever except payments for the work done up-to-date of rescission.

4.19 Execution of Works

4.19.1 Contractor's understanding – It is understood and agreed that the Contract has, by careful examination, satisfied himself as to the nature and location of the work, the conformation of the ground, the character, quality and quantity of the materials to be encountered, the character of equipment and facilities needed preliminary to and during the progress of the works, the general and local conditions, the labour conditions prevailing therein and all other matters which can in any way affect the works under the contract.

4.19.2 Commencement of works – The Contractor shall commence the works immediately after receipt of LoA from the RailTel and shall proceed with the same with due expedition and without delay. The work should be started with due intimation to RailTel.

4.19.3 Accepted programme of work:

The Contractor who has been awarded the work shall as soon as possible but not later than 7 days from the date of receipt of the acceptance letter in respect of contracts with initial completion period of **12 months** or less or not later than 15 days for other contracts have to submit the detailed programme of work indicating the time schedule of various items of works in the form of Bar Chart/PERT/CPM. He shall also submit the details of organization (in terms of labour and supervisors) plant and machinery that he intends to utilize (from time to time) for execution of the work within stipulated date of completion. The programme of work amended as necessary by discussions with the Engineer, shall be treated as the agreed programme of the work for the purpose of this contract and the contractor shall and endeavor to fulfill this programme of work. The progress of work will be watched accordingly and the liquidated damages will be with reference to the overall completion date. Nothing stated herein shall preclude the contractor in achieving earlier completion of item or whole of the works than indicated in the programme.

4.19.4 Setting out of works

The Contractor shall be responsible for the correct setting out of all works in relation to original reference at his cost. The Contractor shall execute the work true to specifications, drawings, plans and dimensions as mentioned in the contract document and as directed by the Engineer's representative and shall check these at frequent intervals. The Contractor shall provide all facilities like labour and instruments and shall cooperate with the Engineer's representative at all time, during the progress of the works. Any error shall appear or arise in any part of the work, the Contractor, on being required so to do by the Engineer's representative shall, at his own rectify such errors, to the satisfaction of the Engineer's representative. Such checking shall not absolve the Contractor of his own responsibility of maintaining accuracy in the work.

4.20 Compliance to Engineer's Instructions

4.20.1 The Engineer shall direct the order in which the several parts of the works shall be executed and the Contractor shall execute without delay all orders given by the Engineer from time to time but the Contractor shall not be relieved thereby from responsibility for the due performance of the works in all respects.

4.20.2 **Alterations to be authorized** – No alterations in or additions to or omissions or abandonment of any part of the works shall be deemed authorized, except under instructions from the Engineer, and the Contractor shall be responsible to obtain such instructions in each and every case in writing from the Engineer.

4.20.3 **Extra Works**

Should works over and above those included in the contract require to be executed at the site, the contractor shall have no right to be entrusted with the execution of such works, which may be carried out by another contractor or contractors or by other means at the sole discretion of the RailTel.

4.20.4 **Separate Contracts in connection with works**

The RailTel shall reserve the right to let other contracts in connection with the works. The Contractor shall afford other contractors reasonable opportunity for the storage of their materials and the execution of their works and shall properly connect and coordinate his work with theirs. If any part of the Contractor's work depends for proper execution or result upon the work of another contractor(s), the Contractor shall inspect and promptly report to the Engineer any defects in such works that render it unsuitable for such proper execution and results. The Contractor's failure so to inspect and report shall constitute as acceptance of the other contractor's work as fit and proper for the reception of his work, except as to defects which may develop in the other contractor's work after the execution of his work.

4.21 Instructions of Engineer's Representative

Any instructions or approval given by the Engineer's representative to Contractor in connection with the works shall bind the Contractor as though it had been given by the Engineer provided always as follows: -

4.21.1 Failure of the Engineer's representative to disapprove any work or materials shall not prejudice the power of the Engineer thereafter to disapprove such work or material and to order the removal or breaking up thereof.

4.21.2 If the Contractor shall be dissatisfied by reason of any decision of the Engineer's representative he shall be entitled to refer the matter to the Engineer who shall there upon confirm or vary such decision.

4.22 **Adherence to specifications and drawings**

4.22.1 The whole of the works shall be executed in perfect conformity with the specifications and drawings of the contract. If the Contractor performs any works in a manner contrary to the specifications or drawings or any of them and without such reference to the Engineer, he shall bear all the costs arising or ensuring there- from and shall be responsible for all loss to the RailTel.

- 4.22.2 **Drawings and specifications on the works:**
- 4.22.2.1 The contractor shall keep one copy of Drawings and specifications at the site, in good order, and such contract documents as may be necessary, available to the Engineer or the Engineer's Representative.
- 4.22.2.2 The supply of equipment and materials shall include supply of one set of printed documents from original equipment manufacturers with each equipment as given in technical supplement.
- 4.22.3 Ownership of Drawings and Specifications – All drawings and Specifications and copies thereof furnished by the RailTel to the Contractor are deemed to be the property of the RailTel. They shall not be used in another works and with the exception of the signed contract set, shall be returned by the Contractor to the RailTel on completion of the work or termination of the Contract.
- 4.22.4 Compliance with Contractor's request for details – The Engineer shall furnish with reasonable promptness, after receipt by him of the Contractor's request for the same, additional instructions by means of drawings of otherwise, necessary for the proper execution of the works or any part thereof. All such drawings and instructions shall be consistent with the Contract Documents and reasonably inferable there from.
- 4.22.5 **Meaning and Intent of specification and drawings**
If any ambiguity arises as to the meaning and intent of any portion of the Specifications and Drawings or as to execution or quality of any work or material, or as to the measurements of the works, the decision of the Engineer thereon shall be final subject to the appeal (within 7 days of such decision being intimated to the Contractor) to the competent authority in RailTel who shall have the power correct any errors, omissions, or discrepancies in aforementioned items and whose decision in the matter in dispute or doubt shall be final and conclusive.
- 4.23 **Working during night**
The Contractor shall not carry out any work between sunset and sunrise without the previous permission of the Engineer. Hence, no "night duty" shall be payable to the contractor for the portion/part of the works to be undertaken during the night.
- 4.24 **Damage to Govt. /RailTel property or private life and property**
The Contractor shall be responsible for all risk to the works and for trespass and shall make good at his own expense all loss or damage whether to the works themselves or any other property of the Railways/RailTel or the lives, persons or property of others from whatsoever cause in connection with the works until they are taken over by the RailTel and this although all reasonable and proper precautions may have been taken by the Contractor, and in case the RailTel shall be called upon to make good any costs, loss or damages, or to pay any compensation, including that payable under the provisions of the Workmen's Compensation Act or any statutory amendments thereof to any person or persons sustaining damages as aforesaid by reason of any act, or any negligence or omissions on the part of the Contractor the amount of any costs or charges including costs and charges in connection with legal proceedings, which the RailTel may incur in reference thereto, shall be charged to the Contractor. The RailTel shall have the power and right to pay or to defend or compromise any claim of threatened legal proceedings or in anticipation of legal proceedings being instituted consequent on the action or default of the Contractor, to take such steps as may be considered necessary or desirable to ward off or mitigate the effect of such proceedings, charging to Contractor, as aforesaid, any sum or sums of money which

may be paid and any expenses whether for reinstatement or otherwise which may be incurred and the propriety of any such payment, defense or compromise, and the incurring of any such expenses shall not be called in question by the Contractor.

4.25 Sheds, Stores houses and Yards

The Contractor shall at his own expense provide himself with sheds, storehouses and yards in such situations and in such numbers as in the opinion of the Engineer is requisite for carrying on the works and the Contractor shall keep at each such sheds, store houses and yards a sufficient quantity of materials and plant in stock so as not to delay the carrying out of the works with due expedition and the Engineer and the Engineer's representative shall have free access to the said sheds, store houses and yards at any time for the purpose of inspecting the stock of materials or plant so kept in hand, and any materials or plant which the Engineer may object to shall not be brought upon or used in the works, but shall be forthwith removed from the sheds, store houses or yards by the contractor. The Contractor shall at his own expenses provide and maintain suitable mortar mills, soaking vats or any other equipments necessary for the execution of the works.

4.26 Provision of efficient and competent staff

The Contractor shall place and keep on the works at all times efficient and competent staff to give the necessary directions to his workmen and to see that they execute their work in sound and proper manner and shall employ only such supervisors, workmen and laborers in or about the execution of any of these works as are careful and skilled in various trades and callings. The Contractor shall at once remove from the works any agents, permitted petty/sub-contractor, supervisor, workman or laborers who shall be objected to by the Engineer and if and whenever required by the Engineer, he shall submit a correct return showing the names of all staff and workmen employed by him. In the event of the Engineer being of the opinion that the Contractor is not employing on the works a sufficient number of staff and workmen as is necessary for the proper completion of the works within the time prescribed, the Contractor shall forthwith on receiving intimation to this effect take on the additional number of staff and labor specified by the Engineer within seven days of being so required and failure on the part of the Contractor to comply with such instructions will entitle the RailTel to rescind the contract under Para 4.62 of these conditions.

4.27 Workmanship and Testing

4.27.1 The whole of the works and/or supply of materials specified and provided in the contract or that may be necessary to be done in order to form and complete any part thereof shall be executed in the best and most substantial workman like manner with materials of the best and most approved quality of their respective kinds, agreeable to the particulars contained in or implied by the specifications and as referred to in and represented by the drawings or in such other additional particulars. Instructions and drawings may be found requisite to be given during the carrying on of the works and to the entire satisfaction of the Engineer according to the instructions and directions, which the Contractors may from time to time receive from the Engineer. The materials may be subjected to tests by Mean of such machines, instruments and appliances as the Engineer may direct and wholly at the expense of the Contractor.

4.27.2 Removal of Improper work and materials – The Engineer or the Engineer's representative shall be entitled to order from time to time:

4.27.2.1 The removal from the site within the time specified in the order of any materials, which in his opinion are not in accordance with the specifications or drawings.

4.27.2.2 The substitution of proper and suitable materials, and

4.27.2.3 The removal and proper re-execution, notwithstanding any previous tests thereof or “on account” payments therefore, of any work which in respect of materials or workmanship is not in his opinion in accordance with the specifications and in case of default on the part of the Contractor in carrying out such order the RailTel shall be entitled to rescind the contract under Para 4.62 of tender document of these conditions.

4.28 Facilities for Inspection

The Contractor shall afford the Engineer and the Engineer’s Representative every facility for entering in and upon every portion of the work at all hours for the purpose of inspection or otherwise and shall provide all labour, materials, instruments, appliances and things of every kinds required for the purpose and the Engineer and the Engineer’s representative shall at all-time have free access to every part of the works and to all places at which materials for the work are stored or being prepared.

4.29 Examination of work before covering up

The Contractor shall give two days notice to the Engineer or the Engineer’s Representative whenever any work or materials are intended to be covered up in the earth, in bodies or walls or otherwise to be placed beyond the Reach of Measurements in order that the work may be inspected or that correct dimension may be taken before being so covered, placed beyond the reach of measurement in default whereof, the same shall at the option of the Engineer or the Engineer’s Representative be uncovered and measured at the contractor’s expense or no allowance shall be made for such work or materials.

4.30 Temporary works

All Temporary works necessary for the proper execution of the works shall be provided and maintained by the Contractor and subject to the consent of the Engineer, shall be removed by him at his expenses when they are no longer required and in such manner as the Engineer shall direct. In the event of failure on the part of the Contractor to remove the temporary works, the Engineer will cause them to be removed and cost as increased by supervision and other incidental charge shall be recovered from the Contractor. If temporary huts are provided by the Contractor on the RailTel/Railway land for labour engaged by him and the work is completed but the contractor’s labour refused to vacate and have to be removed by the RailTel, necessary expenses incurred by the RailTel in connection therewith shall be borne by the Contractor.

4.31 Contractor to supply water for works

4.31.1 Unless otherwise provided in the contract, the contractor shall be responsible for arrangements to obtain supply of water for the works.

4.31.2 Contractor to arrange supply of Electric power for works.

4.31.3 Electric supply from the Railway system

The RailTel may supply to the Contractor part or whole of the electric power wherever available and possible, required for execution of works from the Railway’s existing

electric supply systems at or near the site of works on specified terms and conditions and such charges as shall be determined by the RailTel and payable by the contractor provided the cost of arranging necessary connection to the Railway's Electric supply systems, and laying of underground/overhead conductors, circuit protection, electric power meters, transmission structure, shall be borne by the Contractor and that the contractor shall not be entitled to any compensation or reason for delay for interruption or failure of the Electric supply system.

4.32 Property in material and Plants: Deleted

4.33 Tools, Plant and Materials Supplied by the RailTel: NIL

4.33.1 The Contractor shall take all responsible care of all tools, plants and materials or other property whether of a like description or not belonging to the RailTel and committed to his charge for the purpose of the works and shall be responsible for all damage or loss caused by him, his agents permitted petty/sub-contractor or his workmen or others while they are in his charge. The Contractor shall sign accountable receipts for tools, plants and materials made over to him by the Engineer and on completion of the works shall handover the unused balance of the same to the Engineer in good order and repair, fair wear and tear excepted and shall be responsible for any failure to account for the same or any damage done thereto.

4.34 Precaution during progress of work

4.34.1 During the execution of works, unless otherwise specified the Contractor shall at his own cost provide the materials for and execute all shoring, timbering and strutting works as is necessary for the stability and safety of all structures, excavations and works and shall ensure that no damage, injury, loss is caused or likely to be caused to any person or property.

4.34.2 Roads and water courses: Existing roads or water courses shall not be blocked, cut through, altered, diverted or obstructed in any way by the Contractor, except with the permission of the Engineer. All compensations claimed for any authorized closure, or his agent or his staff shall be recoverable from the Contractor by deduction from any sums which may become due to him in terms of contract or otherwise according to law.

4.34.3 Provision of access to premises: During progress of work in any street or thoroughfare, the Contractor shall make adequate provision of the passage of traffic, for securing safe access to all premises approached from such street or thoroughfare and for any drainage, water supply or meant for lightning which may be interrupted by reason of the execution of the works and shall react and maintain at his own cost barriers, lights and other safeguards as prescribed by the Engineer, for the regulation of the traffic, and provide watchmen necessary to prevent accidents. The works shall in such cases be executed night and day if so ordered by the Engineer and with such vigour so that the traffic way be impeded for as short a time as possible.

4.34.4 Safety of Public: The Contractor shall be responsible to take all precautions to ensure the safety of the public or Railway/RailTel's property and shall post such look out men as may in the opinion of the Engineer be required to comply with regulations pertaining to the work.

4.35 Use of Explosives:

Explosive shall not be used on the works or on the site by the Contractor without the permission of the Engineer and then only in the manner and to the extent to which such permission is given. Where explosives are required for the works, the same shall be stored in a special magazine to be provided by and at the cost of the Contractor in accordance with the Explosive Rules. The Contractor shall obtain the necessary license for the storage and the use of explosives and all operations in which or for which explosives are employed shall be at the sole risk and responsibility of the Contractor and the Contractor shall indemnify the Railway/RailTel in respect thereof.

4.36 Suspension of works

4.36.1 The Contractor shall on the order of Engineer suspend the progress of the works or any part thereof for such time or times and in such manner as the Engineer may consider necessary and shall during such suspension properly protect and secure the work so far as is necessary in the opinion of the Engineer. If such suspension is: -

- (a) Provided for in the contract, or
- (b) Necessary for the proper execution of the works or by the reason of act of God or by some default on the part of the Contractor, and or
- (c) Necessary for the safety of the works or any part thereof.

4.36.2 The Contractor shall not be entitled to the extra costs, if any, incurred by him during the period of suspension of the works; but in the event of any suspension ordered by the Engineer for reasons other than aforementioned and when each such period of suspension exceeds 14 days, the Contractor shall be entitled to such extension of time for completion of the works as the engineer may consider proper having regard to the period or periods of such suspensions and to such compensations as the Engineer may consider reasonable in respect of salaries or wages paid by the Contractor to his employees during the periods of such suspensions.

4.36.3 Suspension lasting more than 3 month – If the progress of the works or any part thereof is suspended on the order of the Engineer for more than three months at a time, the Contractor may serve a written notice on the Engineer requiring permission within 15 days from the receipt thereof to proceed with the works or that part thereof in regard to which progress is suspended and if such permission is not granted within that time the Contractor by further written notice so served may, but is not bound to, elect to treat the suspension where it affects part only of the works as an omission of such part or where it affects the whole of the works, as an abandonment of the contract by the RailTel.

4.37 Rates for items of works

The rates entered in the accepted Schedule Of Requirements of the Contract are intended to provided for works duly and properly completed in accordance with the general and special conditions of the contract and the specifications and drawings together with such enlargements, extensions, diminutions, reductions, alterations or additions as may be ordered in terms of Para 4.42 of these conditions and without prejudice to the generality thereof and shall be deemed to include and cover superintendence and labour, supply including full freight of materials, stores, tools and all apparatus and plant required on the works, except such tools, plant or materials as may be specified in the contract to be supplied to the Contractor by the RailTel, the erection, maintenance and removal of all temporary works and buildings, all

arrangements for the safety of the public or of employees during the execution of works, all sanitary and medical arrangements for labour camps as may be prescribed by the RailTel, the setting of all work and of the construction, repair and upkeep of all center lines, bench marks and level pegs thereon, site clearance, all fees, duties, royalties, rent and compensation to owners for surface damage or taxes and impositions payable to local authorities in respect of land, structures and all material supplied for the work or other duties or expenses for which the Contractor may become liable or may be put under any provision of law for the purpose of or in connection with the execution of the contract, and all such other incidental charges or contingencies as may have been specially provided for in the specifications.

4.38 Demurrage and wharfage dues

4.38.1 Demurrage charges calculated in accordance with the scale in force for the time being on the RailTel and incurred by the Contractor failing to load or unload any goods of materials within the time allowed by RailTel for loadings as also wharfage charges, of materials not removed in time as also charges due on consignments booked by or to him shall be paid by the Contractor, failing which such charges shall be debited to the Contractor's account in the hands of the RailTel and shall be deducted from any sums which may become due to him in terms of the contracts.

4.39 Rates for extra items of works

4.39.1 Any item of work carried out by the Contractor on the instructions of the Engineer which is not included in the accepted schedule of rates shall be executed at the rates set forth in the "Schedule Of Requirements" modified by the tender percentage and such items are not contained in the latter, at the rate agreed upon between the Engineer and the Contractor before the execution of such items of work and the contractors shall be bound to notify the Engineer at least seven days before the necessity arises for the execution of such items of works that the accepted Schedule Of Requirements does not include rate or rates for the extra work involved. The rates payable for such items shall be decided at the meeting to be held between the Engineer and Contractor, in as short a period as possible after the need for the special item has come to the notice. In case the Contractor fails to attend the meeting after being notified to do so or in the event of no settlement being arrived at, the RailTel shall be entitled to execute the extra works by other means and the contractor shall have no claim for loss or damage that may result from such procedure.

4.39.2 Provided that if the Contractor commences work or incurs any expenditure in regard thereto before the rates as determined and agreed upon as lastly hereunto fore mentioned, then and in such a case the Contractor shall only be entitled to be paid in respect of the work carried out or expenditure incurred by him prior to the date of determination of the rates as aforesaid according to the rates as shall be fixed by the Engineer. However if the contractor is not satisfied with the decision of the Engineer in this respect he may appeal to the competent authority of RailTel within 30 days of getting the decision of the Engineer, supported by analysis of the rates claimed. The competent authority of RailTel's decision after hearing both the parties in the matter would be final and binding on the Contractor.

4.40 Handing over of works

4.40.1 The Contractor shall be bound to hand over the works executed under the contract to the RailTel complete in all respect to the satisfaction of the Engineer. The Engineer shall determine the date on which the work is considered to have been completed, in

support of which his certificate shall be regarded as sufficient evidence for all purposes. The engineer shall determine from time to time, the date on which any particular section of the work shall have been completed, and the contractor shall be bound to observe any such determination of the Engineer.

- 4.40.2 Clearance of Site on Completion: On completion of the works the contractor shall clear away and remove from the site all constructional plant, surplus material, rubbish and temporary works of every kind and leave whole of the site and works clean and in a workman like condition to the satisfaction of the Engineer. No final payment in settlement of the accounts for the work shall be paid, held to be due or shall be made to the contractor till, in addition to any other condition necessary for such final payment, site clearance shall have been affected by him, and such clearance may be made by the Engineer at the expense of the Contractor in the event of his failure to comply with this provision within 7 days after receiving notice to that effect. It Should become necessary for the Engineer to have the site cleared at the expense of the Contractor, the RailTel shall not be held liable for any loss or damage to such of the Contractor's property as may be on the site and due to such removal there from which removal may be affected by means of public sales of such materials and property or in such a way as deemed for and convenient to the Engineer.

4.41 Variations in Extent of Contract

- 4.41.1 Modification to Contract to be in writing – In the event of any of the provisions of the Contract requiring to be modified after the contract documents have been signed, the modifications shall be made in writing and signed by the RailTel and the Contractor, and no work shall proceed under such modifications until this has been done. Any verbal or written arrangement abandoning, modifying, extending, reducing or supplementing the Contract or any of the terms thereof shall be deemed conditional and shall not be binding on the RailTel unless and until the same is incorporated in a formal instrument and signed by the RailTel and the Contractor and till then the RailTel shall have the right to repudiate such arrangement.

4.42 Powers of Modification to Contract

- 4.42.1 The Engineer on behalf of the RailTel shall be entitled by order in writing to enlarge or extend, diminish or reduce the works or make any alterations in their design, character, position, site quantities, dimensions or in the method of their execution or in the combination and use of materials for the execution thereof or to order any additional work to be done or any works not to be done and the Contractor will not be entitled to any compensation for any increase / reduction in the quantities of work but will be paid only for the actual amount of work done and for approved materials supplied against a specific order.

- 4.42.2 Unless otherwise specified in the special conditions of the contract, the accepted variation in quantity for each individual item of the contract would be up to $\pm 25\%$ of the quantity originally contracted. The contractor shall be bound to carry out the work at the agreed rates and shall not be entitled to any claim or any compensation, whatsoever upto the limit of $\pm 25\%$ variation in quantity of individual items of works.

- 4.42.3 **Valuation of Variations** – The enlargements, extensions, diminution, reduction, alterations or additions referred to in sub-clause (2) of this clause shall in no degree affect the validity of the contract but shall be performed by the Contractor as provided

therein and be subject to the same conditions, stipulations and obligations as if they had been originally and expressly included and provided for in the specifications and drawings and the amounts to be paid therefore shall be calculated in accordance with the accepted schedule of rates. Any extra items/quantities of work falling outside the purview of the provisions of sub-clause (2) above shall be paid for at the rates determined under clause 4.39 of these conditions.

4.43 Claims

4.43.1 **Monthly Statement of Claims** - The contractor shall prepare and furnish to the Engineer once in every month an account giving full and detailed particulars of all claims for any additional expenses to which the Contractor may consider himself entitled to and of all extra or additional works ordered by the Engineer which he has executed during the preceding month and no claim for payment for and such work will be considered which has not been included in such particulars.

4.43.2 **Signing of “No Claim” Certificate** – The Contractor shall not be entitled to make any claim whatsoever against the RailTel under or by virtue of or arising out of this contract, nor shall the RailTel entertain or consider any such claim, if made by the Contractor, after he shall have signed a ‘No Claim’ certificate in favour of the RailTel, in such form as shall be required by the RailTel, after the works are finally measured up. The Contractor shall be debarred from disputing the correctness of the items covered by “No Claim Certificate” or demanding a preference to arbitration in respect thereof.

4.44 MEASUREMENTS, CERTIFICATES AND PAYMENTS

Qualities in schedule annexed to Contract- The quantities set out in the accepted Schedule of Requirements with items of works quantified are the estimated quantities of the works and they shall not be taken as the actual and correct quantities of the works to be executed by the Contractor in fulfillments of his obligations under the contract.

4.45 **Measurements of Works:** The Contractor shall be paid for the works at the rates in the accepted Schedule of Requirements and for extra works at rates determined under Para 4.39 of these conditions on the measurements taken by the Engineer or the Engineer’s representative in accordance with the rules prescribed for the purpose by the RailTel. The quantities for items the unit of which in the accepted Schedule Of Requirements is 100 or 1000 shall be calculated to the nearest whole number, any fraction below half being dropped and half and above being taken as one; for item the unit of which in the accepted Schedule Of Requirements is single, the quantities shall be calculated to places of decimals. Such measurements will be taken of the work in progress from time to time and at such intervals as in the opinion of the Engineer shall be proper having regard to the progress of works. The date and time on which “on account” or final measurements are to be made shall be communicated to the Contractor who shall represent at the site and shall sign the results of the measurements (which shall also be signed by the Engineer or the Engineer’s representative) recorded in the official measurements book as an acknowledgement of his acceptance of the accuracy of the measurements. Failing the Contractor’s attendance the work may be measured up in his absence and such measurements shall, notwithstanding such absence, be binding upon the Contractor whether or not he shall

have signed the measurement book provided always that any objection made by him to measurement shall be duly investigated and considered in the manner set out below:

- (a) It shall be open to the Contractor to take specific objection to any recorded measurements or Classification on any ground within seven days of the date of such measurements. Any re-measurement taken by the Engineer or the Engineer's representative in the presence of the Contractor or in his absence after due notice has been given to him in consequences of objection made by the contractor shall be final and binding on the Contractor and no claim whatsoever shall thereafter be entertained regarding the accuracy and classification of the measurement.
- (b) If an objection raised by the Contractor is found by the Engineer to be incorrect, the Contractor shall be liable to pay the actual expenses incurred in measurements.

4.46 “On-Account” Payments

4.46.1 The Contractor shall be entitled to be paid from time to time by way of "On-Account" payment only for such works as in the opinion of the Engineer he has executed in terms of the contract. All payments due on the Engineer's or the Engineer's Representative's certificates of measurements shall be subject to any deductions which may be made under these presents and shall further be subject to, unless otherwise required by Para 4.16 of these conditions, a retention of ten percent by way of security deposits, until the amount of security deposit by way of retained Earnest Money and such retentions shall amount to 5% of the total value of the contract provided always that the Engineer may by any certificate make any correction or modification in any previous certificate which shall have been issued by him and that the Engineer may withhold any certificate if the works or any part thereof are not being carried out to his satisfaction.

4.46.2 Rounding off amounts: The total amount due shall be rounded off to the nearest rupee i.e. sums less than 50 paise shall be omitted and sums of 50 paise and more upto Rs. 1/- will be reckoned as Rs. 1/-.

4.46.3 On-Account Payments not prejudicial to final settlements: “On Account” payments made to the Contractor shall be without prejudice to the final making up of the accounts (except where measurement are specifically noted in the Measurement Book as “Final Measurements” and as such have been signed by the Contractor) and shall in no respect be considered or used as evidence of any facts stated in or to be inferred from such account not of any particular quantity of work having been executed not of the manner of its execution being satisfactory.

4.46.4 Manner of payment: Unless otherwise specified payments to the Contractor will be made through RTGS.

4.47 Maintenance of works:

The contractor shall at all times during the progress and continuance of the works and also for the period of warranty specified in the tender form after the date of passing of the certificate of completion by the Engineer or any earlier date subsequent to the completion of the works that may be fixed by the Engineer be responsible for and effectively maintain and uphold in good substantial sound and perfect conditions all and every part of the work and shall make good form time to time and at all times as often as the Engineer shall require. Any damage or defect that may during the above

period arise in or be discovered or be in any way connected with the works, provided that such damage or defect is not directly caused by errors in the contract documents, act of providence or insurrection or civil riot, and the Contractor shall be liable for and make good to the RailTel or other persons legally entitled thereto whenever required by the Engineer so to do, all losses, damage, costs and expenses they or any of them may incur or be put or be liable, by reason or in consequence of the operations of the contractor or of his failure in any respect. For this purpose the tenderer will submit their strategy for providing maintenance support including the staff that will be available along with the set of spares for attending to various faults/problems during maintenance period.

4.48 Certificate of Completion of works

4.48.1 As soon as in the opinion of the Engineer the whole work have been completed and has satisfactorily passed any final test or tests that may be prescribed, the Engineer shall issue a Provisional Acceptance Certificate in respect of the works and period of warranty shall commence from the date of issue of Last Provisional Acceptance Certificate Minor defects pointed out while issuing PACs shall be attended by the contractor within reasonable period of time to the satisfaction of Engineer.

4.48.2 Contractor not absolved by Provisional completion Certificate (PAC): The Certificate of completion in respect of the works referred to in Para 4.48.1 of this clause shall not absolve the Contractor from his liability to make good any defect, imperfection, shrinkages or faults which may appear during the period of maintenance specified in the tender arising in the opinion of the Engineer from materials or workmanship not in accordance with the drawing or specifications or instructions of the Engineer, which defect, imperfections, shrinkages or faults shall upon the direction in writing of the Engineer, be amended and made good by the Contractor at his own cost; and in case of default on the part of Contractor the Engineer may employ, labour and material or appoint another Contractor to amend and make good such defect, imperfections, shrinkages and faults and all expenses consequent thereon and incidental thereto shall be borne by the Contractor and shall be recoverable from any moneys due to him under the contract.

4.49 Approval only by Final Acceptance Certificate (FAC)

No certificate other than Final Acceptance Certificate referred to in Para 4.50 of the conditions shall be deemed to constitute approval of any work or other matter in respect of which it is issued or shall be taken as an admission of the due performance of the contract or any part thereof or of the accuracy of any demand made by the Contractor or of additional varied work having been ordered by the Engineer nor shall any other certificate conclude or prejudice any of the powers of the Engineers.

4.50 Final Acceptance Certificate:

4.50.1 The contract shall not be considered as completed until a maintenance Certificate shall have been signed by the Engineer stating that the works have been completed and maintained to this satisfaction. The maintenance certificate shall be given by the Engineer upon the expiration of the period of or as soon thereafter as any work ordered during such period pursuant to Para 4.48.2 of these conditions shall have been completed to the satisfaction of the Engineer and full effect shall be given to this Clause notwithstanding the taking possession of or using the works or any part thereof by the RailTel.

- 4.50.2 **Cessation of RailTel's Liability:** The RailTel shall not be liable to the Contractor for any matter arising of or in connection with the contract of the execution of the works unless the Contractor shall have made a claim in writing in respect thereof before the issue of the Maintenance Certificate (FAC) under this clause.
- 4.50.3 **Unfulfilled obligations** - Notwithstanding the issue of the Maintenance Certificate the Contractor and (subject to Para 4.50.2) RailTel shall remain liable for the fulfillment of any obligation incurred under the provision of the contract prior to the issue of the maintenance Certificate which remains unperformed at the time such certificate is issued and for the purposes of determining the nature and extent of any such obligations the contract shall be deemed to remain in force between the parties thereto.
- 4.51 Final payment:**
- 4.51.1 On the Engineer's certificate of completion in respect of the works an adjustment shall be made and the balance of account based on the Engineer or the Engineer's representative's on the accepted schedule or rates and for extra works on rates determined under Para 4.39 of these conditions shall be paid to the Contractor subject always to any deduction which may be made under these presents and further subject to the Contractor having delivered to the Engineer either a full account in detail of all claims he may have on the RailTel in respect of the works or having delivered "No Claim" Certificate and the Engineer having after the receipt of such account given a certificate in writing that such claim are correct, that the whole of the works to be done under the provisions of the Contracts have been completed, that they have been inspected by him since their completion and found to be in good and substantial order, that all properties, works and things removed, disturbed or injured in consequence of the works have been property replaced and made good and all expenses and demands incurred by or made upon the RailTel for or in the respect of damage or good and all expenses and demands incurred by or made upon the RailTel for or in the respect of damage or good and all expenses and demands incurred by or made upon the RailTel for or in the respect of damage or loss by from kin consequence of the works, have been satisfied agreeably and in conformity with the contract.
- 4.51.2 **Post payment Audit** – It is an agreed term of contract that the RailTel reserves to itself the right to carry out a post-payment audit and or technical examination of the works and the final bill including all supporting vouchers, abstracts, etc., and to make a claim on the contractor for the refund any excess amount paid to him if as a result of such examination any over-payment to him is discovered to have been made in respect of any work done or alleged to have been done by him under the contract.
- 4.51.3 **Production of vouchers etc. by the Contractor**
- (i) For a contract of more than one crore of rupees, the contractor shall, whenever required, produce for examination by the Engineer any quotation, invoice, cost or other account, book of accounts, voucher, receipt letter, memorandum, paper of writing or any copy of or extract from any such document and also furnish information and returns verified in such manner as may be required in any way relating to the execution of this contract or relevant for verifying or ascertaining cost of execution of this contract (the decision of the Engineer on the question of relevancy of any documents, information or return being final and binding on the parties). The contractor shall similarly produce vouchers, etc., if required to prove

to the Engineer, that materials supplied by him, are in accordance with the specifications laid down in the contract.

- (ii) If any portion of the work in a contract of value more than one crore of rupees be carried out by the a sub -contractor or any subsidiary or allied firm or company (as per Para 4.7 of the General Conditions of Contract), the Engineer shall have power to secure the book of such sub-contract or any subsidiary or allied firm or company, through the contractor, and such book shall be open to his inspection.
- (iii) The obligations imposed by Para 4.51.3 (i) and (ii) above is without prejudice to the obligations of the contractor under any statute rules or orders binding on the contractor.

4.52 Withholding and lien in respect of sums claimed

Whenever any claim or claims for payment of a sum of money arises out of or under the contract against the contractor, the RailTel shall be entitled to withhold and also have a lien to retain such sum or sums in whole or in part from the security, if any, deposited by the contractor and for the purpose aforesaid, the RailTel shall be entitled to withhold the said security deposit or the security if any, furnished as the case may be and also have a lien over the same pending finalization or adjudication of any such claim. In the event of the security being insufficient to cover the claimed amount or amounts or if no security has been taken from the contractor, the RailTel shall be entitled to withhold and have a lien to the extent of the such claimed amount or amounts referred to supra from any sum or sums found payable or which at any time thereafter may become payable to the contractor under the same contract or any other contract with this or any other RailTel or any Department of the Central Government pending finalization or adjudication of any such claim. It is an agreed term of the contract that the sum of money or moneys so withheld or retained under the lien referred to above, by the RailTel's will be kept withheld or retained as such by the RailTel till the claim arising out of or under the contract is determined by the arbitrator (if the Contract is covered by the arbitration clause) or by the competent court as the case may be and that the contractor will have no claim for interest or damages whatsoever on any account in respect of such withholding or retention under the lien referred to supra and duly notified as such to the contractor. For the purpose of this clause, where the contractor is a partnership firm or a limited company, the RailTel shall be entitled to withhold and also have a lien to retain towards such claimed amount or amounts in whole or in part from any sum found payable to any partner/limited company, as the case may be whether in his individual capacity or otherwise.

- 4.52.1 Lien in respect of claims in Other Contracts** – Any sum of money due and payable to the contractor (Including the security deposit returnable to him) under the contract may be withheld or retained by way of lien by the RailTel, against any claim of this or any other RailTel or any other Department of the Central Government in respect of payment of a sum of money arising out of or under any other contract made by the contractor with this or any other Department of Central Government. It is an agreed term of the contract that the sum of money so withheld or retained under this clause by the RailTel will be kept withheld or retained as such by the RailTel till the Claim arising out of or under any other contract is either mutually settled or determined by arbitration, if the other contract is governed by arbitration clause or by the competent court as the case may be and contractor shall have no claim for interest of money withheld or retained under this clause and duly notified as such to the contractor.

4.53 Signature on Receipts for Amounts

Every receipt which may become payable or for any security which may become transferable to the Contractors under these presents, shall, if signed in the partnership name by any one of the partners of a Contractors firm be a good and sufficient discharge to the RailTel in respect of the moneys or security purported to be acknowledged thereby and in the event of death of any of the Contractor partners during the pendency of the contract it is hereby expressly agreed that every receipt by any one of the surviving Contractor partners shall if so signed as aforesaid be good and sufficient discharge as aforesaid provided that nothing in this clause contained shall be deemed to prejudice or effect any claim which the RailTel may

hereafter have against the legal representative of any contractor partner so dying, for or in respect of any breach of any of the conditions of the contract, provided also, that nothing in this clause contained shall be deemed to prejudice or effect the respective rights or obligations of the Contractor partners and of the legal representative of any deceased Contractor partners interest.

4.54 LABOUR

4.54.1 **Wages to Labour** – The Contractor shall be responsible to ensure compliance with the provisions of the Minimum Wages Act, 1948 (hereinafter referred to as the “said Act”) and the Rules made there-under in respect of any employees directly or through petty contractors or sub-contractors employed by him on road construction or in building operations or in stone breaking or stone crushing for the purpose of carrying out this contract. If in compliance with the terms of the contract, the contractor supplied any labour to be used wholly or partly under the direct orders and control of the RailTel whether in connection with any work being executed by the contractor or otherwise for the purpose of the RailTel such labour shall, for the purpose of this clause, still be deemed to be persons employed by the Contractor. If any moneys shall as a result of any claim or any claim or application made under the said Act be directed to be paid by the RailTel’s, such moneys shall be deemed to be moneys payable to the RailTel by the Contractor and on failure by the Contractor to repay any moneys paid by it as aforesaid within seven days after the same shall have been demanded, the RailTel’s shall be entitled to recover the same form any moneys due or accruing to the contractor under this or any other Contractor with the RailTel’s.

4.54.2 **Apprentices Act** – The Contractor shall be responsible to ensure compliance with the provisions of the Apprentices Act 1961 and the Rules and Orders issued there- under from time to time in respect of apprentices directly through petty contractors or sub-contractors employed by him for purpose of carrying out the contract. If the Contractor directly or through petty contractor or sub-contractors fails to do so, his failure will be a breach of the contract and the RailTel may, in its discretion, rescind the contract. The contractor shall also be liable for any pecuniary liability arising on account of any violation of the provisions of the Act.

4.55 Provisions of Payments of Wages Act

The Contractor shall comply with the provisions of the Payment of Wages Act, 1936 and the rules made thereunder in respect of all employees directly or through petty contractors or sub-contractors employed by him in the works. If in compliance with the terms of the contract, the contractor directly or through petty contractors or sub -contractors shall supply any labour to be used wholly or partly under the direct orders and control of the Engineer whether in connection with the works to be executed

hereunder or otherwise for the purpose of the Engineer such labour shall nevertheless be deemed to comprise persons employed by the contractor, and any moneys which may be ordered to be paid by the Engineer shall be deemed to be moneys payable by the Engineer on moneys due to the contractor in terms of the contract. The RailTel shall be entitled to deduct from any moneys due to the contractor (Whether under this contract or any other contract all moneys paid or payable by the RailTel by way of compensation of aforesaid or for costs of expenses in connection with any claim thereto and the decision of the Engineer upon any question arising out of the effect or force of this clause shall be final and binding upon the contractor.

4.55.1 Provision of Contract Labour (Regulation and Abolition) Act, 1970

- (1) The Contractor shall comply with the provision of the Contract Labour (Regulation and Abolition) Act, 1970 and the Contract Labour (Regulation and Abolition) Act, Central Rules, 1971 as modified from time to time, whenever applicable and shall also indemnify the RailTel from and against any claims under the aforesaid Act and the Rules
- (2) The Contractor shall obtain a valid license under the aforesaid Act as modified from time to time before the commencement of the work and continue to have a valid license until the completion of the work. Any failure to fulfill this requirement shall attract the penal provision of the Contract arising out of the resultant non- execution of the work.
- (3) The Contractor shall pay to the labour employed by him directly or through sub-contractors the wages as per provisions of the aforesaid Act and the Rules wherever applicable. The Contractor shall notwithstanding the provisions of the contract to the contrary, because to be paid the wages to labour indirectly engaged on the work including any engaged by his sub-contractors in connection with the said work, as if the labour had been immediately employed by him.
- (4) In respect of all labour directly or indirectly employed in the work for performance of the contractor's part of the contract the contractor shall comply with or cause to be complied with the provisions of the aforesaid Act and the Rules wherever applicable.
- (5) In every case in which, by virtue of the provisions of the aforesaid Act or the Rules, the RailTel is obliged to pay any amount of wages to a workmen employed by the contractor or his sub-contractor in execution of the work or to incur any expenditure in providing welfare and health amenities required to be provided under the aforesaid Act and the Rules or to incur any expenditure in providing welfare and health amenities required to be provided under the aforesaid Act the Rules or to incur any expenditure on account of the contingent liability of the RailTel due to contractor's failure to fulfill his statutory obligations under the aforesaid Act or the Rules the RailTel will recover from the contractor, the amount of wages so paid or the amount of expenditure so incurred, and without prejudice to the rights of the RailTel under section 20, sub-section (2) and section 2 sub - section (4) of the aforesaid Act, the RailTel shall be at liberty to recover such amount or part thereof by deducting it from the security deposit and/or from any sum due by the RailTel to the contractor whether under the contract or otherwise. The RailTel shall not be

bound to contest any claim made against it under sub- section (1) of section 20 and sub-section (4) of section 21 of the aforesaid Act except on the written request of the contractor and upon his giving to the RailTel full security for all costs for which the RailTel might become liable in contesting such claim. The decision of the RailTel regarding the amount actually recoverable from the contractor as stated above shall be final and binding on the contractor.

- (6) All contractors are required to upload details of their LOAs, engaged workmen, wage payment details, PF/ESI details, bonus details etc., on monthly basis. The details so uploaded shall be available in public domain.
- A. Contractor is to abide by the provision of payment of Wages act & Minimum Wages act. Contractor shall register his firm/company etc. and upload requisite details of labour and their payment in Shramikkalyan portal. These details shall be available in public domain. The Registration/ updation of Portal shall be done as under.
- (a) Contractor shall apply for onetime registration of his company/firm etc. in the Shramikkalyan portal with requisite details subsequent to issue of Letter of Acceptance. Engineer shall approve the contractor's registration on the portal within 7 days of receipt of such request.
- (b) Contractor once approved by any Engineer, can create password with login ID (PAN No.) for subsequent use of portal for all LOAs issued in his favour.
- (c) The contractor once registered on the portal shall provide details of his Letter of Acceptance (LOA)/ Contract Agreements on Shramikkalyan portal within 15 days of issue of any LOA for approval of concerned engineer. Engineer shall update (if required) and approve the details of LOA filled by contractor within 7 days of receipt of such request.
- (d) After approval of LOA by Engineer, contractor shall fill the salient details of contract labours engaged in the contract and ensure updating of each wage payment to them on Shramikkalyan portal on monthly basis.
- (e) It shall be mandatory upon the contractor to ensure correct and prompt uploading of all salient details of engaged contractual labour & payments made thereof after each wage period.
- B. While processing payment of any 'On Account bill' or 'Final bill' or release of 'Advances' or 'Performance Guarantee/ Security deposit', Contractor shall submit a certificate to the Engineer or Engineer's representatives that "I have uploaded the correct details of contract labours engaged in connection with this contract and payments made to them during the wages period in Shramikkalyan portal tillMonth.....Year."

4.56 Reporting of Accidents to Labour

The Contractor shall be responsible for the safety of all employees directly or through petty contractors or sub-contractors employed by him on the works and shall report serious accidents to any of them however and wherever occurring on the works to the Engineer or the Engineer's Representative and shall make every arrangement to render all possible assistance.

4.57 Provisions of Workmen's Compensation Act

In every case in which by virtue of the provision of Section 12 sub-section (1) of the Workmen's Compensation Act, 1923, RailTel is obliged to pay compensation to a workman directly or through the petty Contractor employed by the Contractor or sub-contractor in executing the work, RailTel will recover from the contractor the amount of the compensation so paid, and, without prejudice to the right of RailTel under Section 12 sub-section (2) of the said Act. RailTel shall be at liberty to recover such amount or any part thereof by deducting it from the security deposit or from any sum due by RailTel to the Contractor whether under these conditions or otherwise, RailTel shall not be bound to contest any claim made against it under Section 12, sub-section (1) of the said Act except on the written request of the Contractor and upon his giving to RailTel full security for all costs for which RailTel might become liable in consequence of contesting such claim.

4.58 RailTel not to provide quarters for Contractor

No quarters shall be provided by the RailTel for the accommodation of the contractor or any of his staff employed on the work.

4.59 Labour camps

(1) The Contractor shall at his own expense make adequate arrangements for the housing, supply of drinking water and provision of latrines and urinals for his staff and workman directly or through the petty contractors or sub-contractors and for temporary crèche (Bal-Mandir) where 50 or more women are employed at a time. Suitable sites on Railway/RailTel land, if available, may be allotted to the Contractor for the erection of labour camps either free of charge or on such terms and conditions that may be prescribed by the RailTel. All camp sites shall be maintained in clean and sanitary conditions by the Contractor at his own cost.

(2) Compliance to Rules for Employment of Labour

The Contractor(s) shall conform to all laws, bye-laws, rules and regulations for the time being in force pertaining to the employment of local or imported labour and shall take all necessary precautions to ensure and preserve the health and safety of all staff employed directly or through petty Contractors or sub -contractors on the works.

(3) Preservation of Peace – The Contractor shall take requisite precautions and use his best endeavors to prevent any riotous or unlawful behavior by or amongst his workmen and others employed directly or through petty contractor or sub-contractors on the works and preserve the health and safety of all staff employed directly or through petty Contractors or sub -contractors on the works.

(4) Sanitary Arrangement – The contractor shall obey all sanitary rules and carry out all sanitary measures that may time to time be prescribed by the RailTel Medical Authority and permit inspection of all sanitary arrangements at all times by the Engineer, the Engineer's Representative or the Medical Staff of the RailTel. Should the Contractor fail to make adequate sanitary arrangements, these will be provided by the RailTel and the cost therefore recovered from the contractor.

(5) Outbreak of Infectious Disease – The Contractor shall remove from his camp such labour and their families as refuse protective inoculation and vaccination when called upon to do so by the Engineer or the Engineer's Representative on the advice of the Railway/RailTel Medical Authority. Should Cholera, Plague or other

infectious disease break out, the Contractor shall burn the huts, beddings, clothes and other belongings of or used by the infected parties and promptly erect new huts on healthy sites as required by the engineer, failing which within the time specified in the Engineer's requisition, the work may be done by the RailTel and the cost therefore recovered from the Contractor.

- (6) Treatment of Contractor's staff in Railway Hospitals – Deleted
- (7) **Medical facilities at site** – The contractor shall provide medical facilities at the site as may be prescribed by the engineer on the advice of the medical authority in relation to the strength of the contractor's resident staff, and workmen.
- (8) **Use of Intoxicants** – The sale of ardent spirits or other intoxicating beverages upon the work or in any of the buildings, encampments or tenements owned, occupied by or within the control of the Contractor or any of his employees shall be forbidden and the Contractor shall exercise his influence and authority to the utmost extent to secure strict compliance with this condition.
- (9) **Non-employment of Female Labour** – The contractor shall see that the employment of female labour in cantonment areas, particularly in the neighborhood of soldier's barracks, should be avoided as far as possible.
- (10) Restrictions on the employment of retired Engineers of Railway/Govt. services within two years of their Retirement– The contractor shall not, if he is a retired government engineer of Gazetted rank, who has not completed two years from the date of retirement, in connection with his contract in any manner whatsoever without obtaining prior permission of the President and if the contractor is found to have contravened this provision, it will constitute a breach of contract Administration will be entitled to terminate the contract at the risk and cost of the contractor and forfeit his security deposit.

4.60 Non-Employment of Labourers below the age of 15

- (1) The Contractor shall not employ children below the age of 15 as labourers directly or through petty contractors or sub-contractors for the execution of work.
- (2) **Medical Certificate of Fitness for Labour** – It is agreed that the contractor shall not employ a person above 15 and below 19 years of age for the purpose of execution of work under this contract unless a medical certificate of fitness in the prescribed form is granted to him by a certifying surgeon certifying that he is fit to work as an adult is obtained and kept in the custody of the contractor or a person nominated by him in this behalf and the person carries with him, while at work, a token giving a reference to such certificate. It is further agreed that the responsibility for having the adolescent examined medically at the time of appointment or periodically till he attains the age of 19 years shall devolve entirely on the contractor and all the expense to be incurred on this account shall be borne by him and no fee shall be charged from the adolescent or his parent for such medical examination.
- (3) **Period of Validity of Medical Fitness Certificate** - A certificate of fitness granted or renewed for the above said purposes shall be valid only for a period of one year at a time. The certifying surgeon shall revoke a certificate granted or

renewed if in his opinion the holder of it is, no longer fit for work in the capacity stated therein. Where a certifying surgeon refuses to grant or renew a certificate or revoke a certificate, he shall, if so required by the person concerned, stated his reasons in writing for doing so.

- (4) **Medical Re-examination of Labourer** - Where any official appointed in this behalf by the Ministry of Labour is of the opinion that any person employed in connection with the execution of any work under this contract in the age group 15-19 years is without a certificate of fitness or is having a certificate of fitness but no longer fit to work in the capacity stated in the certificate, he may serve on the Contractor, or on the person nominated by him in this regard, a notice requiring that such person shall be examined by a certifying surgeon and such person shall not, if the concerned official so directs, be employed or permitted to do any work under this contract unless he has been medically examined and certified that he has been granted a certificate of illness or a fresh certificate or a fresh certificate of illness, as the case may be.

4.61 Determination of Contract

4.61.1 **Right of RailTel to determine the contract:** The RailTel shall be entitled to determine and terminate the contract at any time, should in the RailTel's opinion, the cessation of work becomes necessary owing to paucity of funds or from any other cause whatever, in which case the value of approved materials at site and of work done to date by the Contractor will be paid for in full at the rate specified in the contract. Notice in writing from the RailTel of such determination and the reasons therefore shall be conclusive evidence thereof.

4.61.2 **Payment on determination of contract:** Should the contract be determined under Para 4.61.1 and the Contractor claims payment for expenditure incurred by him in the expectation of completing the whole of the work, the RailTel shall admit and consider such claims as are deemed reasonable and are supported by vouchers to the satisfactions of the Engineer. The RailTel's decision on the necessity and propriety of such expenditure shall be final and conclusive.

4.61.3 The contractor shall have no claim to any payment of compensation or otherwise, howsoever on account of any profit or advantage which he might have derived from the execution of the work in full but which he did not derive in consequence of determination of contract.

4.62 TERMINATION OF CONTRACT OWING TO DEFAULT OF CONTRACTOR:

4.62.1 (A) If the Contractor:

- (i) becomes bankrupt or insolvent, or
- (ii) Make an arrangement with or assignment in favour of his creditors, or
- (iii) Being a Company or Corporation, go into liquidation (other than voluntary), liquidation for the purpose of amalgamation or reconstruction, or
- (iv) have an execution levied on his goods or property on the works, or assign the contract or any part thereof otherwise than as provided in Para 5.21 of SC, or
- (v) have an execution levied on his goods or property on the works, or assign the contract or any part thereof otherwise than as provided in Para 5.21 of SCC, or
- (vi) persistently disregard the instructions of the RailTel's Engineer with regard to work quality or progress during execution of work or contravene any provision of the contract, or

- (viii) fail to adhere to the agreed programme of work by a margin of 10% of the Stipulated period, or fail to remove materials from the site or to pull down and replace the work after receiving from the Engineer's notice to the effect that the said materials or works have been condemned or rejected, or
 - (ix) Fail to take steps to employ competent or additional staff and labour as required under Para 4.26 of tender document.
 - (x) Fail to afford the Engineer or Engineer's representative proper facilities for inspecting the works or any part thereof as required under Para 4.28 of tender document, or
 - (xi) Promise offer or give any bribe, commission, gift or advantage either himself or through his partner, agent or servant to any officer or employee of RailTel or any person on his or on their behalf in relation to the execution of this or any other contract with the RailTel,
 - (xii) At any time after the tender relating to the contract has been signed and submitted by the contractor, being a partnership firm admit as one of its partners or employ under it or being an incorporated company elect or nominate or allow to act as one of its directors or employ under it in any capacity whatsoever any retired engineer of the gazetted rank or any other retired gazetted officer working before his retirement, whether in the executive or administrative capacity, or whether holding any pensionable post or not, in the Engineering Department of the Railways for the time being owned and administered by the President of India before the expiry of two years from the date of retirement from the said service of such Engineer or Officer unless such Engineer or Officer has obtained permission from the President of India or any officer duly authorized by him in this behalf to become a partner or a director or to take employment under the contract as the case may be, or
- (B) Fail to give at time of submitting the said tender:
- (a) The correct information as to the date of retirement of such retired engineer or retired officer from the said service, or as to whether any such retired engineer or retired officer was under the employment of the contractor at the time of submitting the said tender, or
 - (b) The correct information as to such engineers or officers obtaining permission to take employment under the contractor, or
 - (c) Being a partnership firm the correct information as to, whether any of its partners was such a retired engineer or retired officer, or
 - (d) Being an incorporated company, the correct information as to, whether any of its directors was such a retired engineer or retired officer, or
 - (e) being such a retired engineer or retired officer suppress and not disclose at the time of submitting the said tender the fact of his being such a retired engineer or a retired officer or make at the time of submitting the said tender a wrong statement in relation to his obtaining permission to take the contract or if the contractor be a partnership firm or an incorporated company to be a partner or director of such firm or company as the case may be or to seek employment under the contractor. Then and in any of these said clauses, the Engineer on behalf of the RailTel may serve the Contractor with a notice in writing to that effect and if the Contractor does not, within 7 days after the delivery to him of such notice, proceed to make good his default in so far as the same is capable of being made good and carry on the work or comply with such directions as aforesaid to the entire satisfaction of the Engineer, the RailTel shall be entitled after giving 48 hours notice in writing under the hand of the Engineer to rescind the contract as a whole or in part or parts (as may be

specified in such notice) and adopt either or both the following courses: A final termination notice will be issued by RailTel after expiry of 48 hrs notice.

4.62.2 **RIGHT OF RAILTEL AFTER TERMINATION OF CONTRACT OWING TO DEFAULT OF CONTRACTOR:**

In the event of any or several of the courses, referred in Para 4.62.1 of tender document above, being adopted:

- (a) The Contractor shall have no claim to compensation for any loss sustained by him by reason of his having purchased or procured any materials or entered into any commitments or made any advances on account of or with a view to the execution of the works or the performance of the contract and Contractor shall not be entitled to recover or be paid any sum for any works thereto not actually performed under the contract, unless or until the Engineer shall have certified the performance of such work and the value payable in respect thereof and the Contractor shall only be entitled to be paid the value so certified.
- (b) The Engineer or Engineer's Representative shall be entitled to take possession of any materials, tools, implements, machinery or buildings on the works or on the property on which these are being or ought to have been executed, and to retain the (employ the same) in the further execution of the works or any part thereof until the completion of the works without the Contractor being entitled to any compensation for the use and employment thereof or for wear and tear or destruction thereof.
- (c) The Engineer shall, as soon as may be practicable after removal of the Contractor fix and determine expert or by or after reference to the parties or after such investigation or enquiries as he may consider fit to make or institute and shall certify what amount (if any) has at the time of termination of the contract been reasonably earned by or would reasonably accrue to the Contractor in respect of the work then actually done by him under the contract what was the value of any unused or partially used materials, any constructional plants and any temporary works upon the site. The legitimate amount due to the contractor after making necessary deductions and certified by the Engineer should be released expeditiously.

4.63 Matters finally determined by the RailTel: All disputes and differences of any kind whatsoever arising out of or in connection with the contract, whether during the progress of the work or after its completion and whether before or after the determination of the contract shall be referred by the contractor to the RailTel and the RailTel shall be 120 days receipt of the Contractor's representation make and notify decisions on all matters referred to by the contractor in writing provided that matters for which provision has been made in Para 4.8, 4.18, 4.22.5,4.29, 4.43.2,4.45(a), 4.55, 4.55.1(5), 4.57,4.61.1, 4.61.2 and 4.62.1(A) of General Condition of Contract or in any clause of the Special Conditions of the Contract shall be deemed as 'excepted matters' and decisions of the RailTel's authority, thereon shall be final and binding on the contractor provided further that 'excepted matters' shall stand specifically excluded from the purview of the arbitration clause and not be referred to arbitration.

4.64 **SETTLEMENT OF DISPUTE AND ARBITRATION**

4.64.1 Any dispute or difference whatsoever arising between the parties out of or relating to the construction, meaning, scope, operation or effect of this contract or the validity or the breach thereof shall be settled by a sole arbitrator in accordance with provisions

- contained in Arbitration and Conciliation Act, 1996 as amended and the award made in pursuance thereof shall be binding on the parties. The venue of such arbitration or proceedings thereof shall be New Delhi.
- 4.64.2 All arbitration proceedings shall be conducted in English. Resources against any Arbitral award so rendered may be entered into court having jurisdiction or application may be made to such court for the order of enforcement as the case may be.
- 4.64.3 The Arbitral Tribunal shall consist of the sole Arbitrator if the value of claim is upto Rs. 10 Lakhs. The arbitrator will be appointed by the Managing Director of RailTel Corporation of India Ltd. If the value of claim or amount under dispute is more than Rs. 10 Lakhs, the matter shall be referred to the adjudication of arbitral council. Chairman cum Managing Director/RailTel shall furnish a panel of three names to the contractor, out of which the contractor will recommend one name to be his nominee and then Chairman cum Managing Director/RailTel shall appoint out of the panel, one name as RailTel's nominee and these two arbitrators with mutual consent appoint a third arbitrator who shall act as deciding. The award of the sole arbitrator or the Arbitral council, as the case may be, shall be final and binding on both the parties, i.e. Contractor and RailTel Corporation of India Ltd.
- 4.64.4 Each of the parties agree that notwithstanding that the matter may be referred to Arbitrator as provided therein, the parties shall nevertheless pending the resolution of the controversy or disagreement continue to fulfill their obligation under this Agreement so far as they are reasonably able to do so.

रेलटेल
RAILTEL

A Government of India
Undertaking

CHAPTER - 5

SPECIAL CONDITIONS OF CONTRACT

Para	Subject
5.1	Tender Document
5.2	Agreement
5.3	Security Deposit
5.4	Contractor's Office & Stores depot
5.5	Use of Railway Land
5.6	Program of work.
5.7	Competent Supervisors
5.8	Stores to be supplied by RailTel
5.9	Engagement of Qualified Engineer
5.10	TEST & MEASURING INSTRUMENTS AND SPECIAL TOOLS ETC.
5.11	STORES TO BE SUPPLIED BY CONTRACTOR
5.12	Supply of Technical Literatures, Documentation Drawings, Instruction Book & Completion Plan etc.
5.13	Spares
5.14	Long term availability of spares & System support
5.15	Quality Assurance
5.16	Not used
5.17	Inspection of Materials
5.18	Inspection of Works
5.19	Quantum of work and variation in Quantities
5.20	Not used
5.21	Subletting and Assignment
5.22	Execution of Works
5.23	Not used
5.24	Maintenance of Works
5.25	Clearance of Site
5.26	Provisional Acceptance Certificate (PAC)
5.27	Maintenance of work till issue of Last PAC
5.28	Final Acceptance Certificate (FAC)
5.29	Warranty

- 5.30 Training
- 5.31 Infringement of Patents
- 5.32 License as per Govt. of India Contract Labour Act
- 5.33 Defaults and Delays
- 5.34 Loss Sustained Due to Default and Delay
- 5.35 Penalty for Delay in Completion
- 5.36 Adherence of time schedule
- 5.37 Contractors liabilities for Costs and Damages
- 5.38 Prices
- 5.39 Measurement of Works
- 5.40 Terms of Payments
- 5.41 Final Payment
- 5.42 Final Settlement
- 5.43 Certificate for CENVAT BENEFITS on bills
- 5.44 Deductions from On Account Payment Bills
- 5.45 Taxes
- 5.46 Mobilization Advance
- 5.47 Insurance
- 5.48 Force Majeure Clause
- 5.49 Settlement of dispute and Arbitration.

रेलटेल
RAILTEL

A Government of India
Undertaking

SPECIAL CONDITIONS OF CONTRACT

5.1 TENDER DOCUMENTS

- 5.1.1 The goods and services required, bidding procedure and contract terms are prescribed in the tender documents. The set of tender documents issued for the purpose of bidding includes following together with any addendum and corrigendum thereto.
- 5.1.2 If the Tender submitted by a Tenderer is accepted and the contract awarded to the Tenderer, the various works coming under the purview of the contract shall be governed by tender documents mentioned above.
- 5.1.3 Any special conditions stated by the Tenderer in the covering letter submitted along with the tender shall be deemed to be a part of the Contract to such extent only as have been explicitly accepted by the RailTel .

5.2 AGREEMENT

- 5.2.1 The successful Tenderer shall within 15 days after having been called upon by notice to do so be bound to execute an agreement based on accepted rates and conditions, in such form as the RailTel may prescribe, and lodge the same with the RailTel together with the conditions of contract, specifications and Schedule Of Requirements referred to therein duly completed. The form for agreement is included in , Chapter - 6 (Form No.3).
- 5.2.2 In the event of any tenderer whose tender is accepted, refused to execute the Contract documents as herein before provided RailTel may determine that such tenderer has abandoned the contract and thereupon his tender and the acceptance thereof shall be treated and RailTel shall be entitled to forfeit the full amount of the Earnest Money and to recover the liquidated damage for such default.

5.3 SECURITY DEPOSIT

Refer para 4.16 of chapter-4.

5.4 CONTRACTOR'S OFFICE & STORES DEPOT

The Contractor shall within 10(ten) days of issue of letter of acceptance of tender establish an office and store depot at a convenient place for receiving and storing equipments and materials and progressing field work expeditiously in consultation and with the approval of the purchaser's Engineer. He shall intimate the address thereof to which all correspondence should be sent. Any communication sent to the contractor by post at his said address shall be deemed to have reached the contractor duly and in time. Important documents shall be sent by Registered post.

5.5 USE OF RAILWAY LAND :

Use of Railway land required by the Contractor for construction of temporary offices, quarter(s), hutments etc. for the staff and for storing materials etc. will be permitted to him/them subject to approval by Railways, if available at the charges prescribed by the Railways. The land will be restored to Railways by the Contractor(s) in the same condition as when taken over or in vacant condition as desired by the Engineer after completion of the work or at any earlier day as specified by the Engineer. Failure to do so will make the Contractor(s) liable to pay the cost incurred by the Railway for getting possession of land.

5.6 PROGRAMME OF WORK

5.6.1 Refer Para 4.19,4.20,4.21,4.22,4.23 and 4.26.

5.6.2 The contractor will program his work in such a manner so as not to interfere in the working and movement of traffic.

5.7 COMPETENT SUPERVISORS

Refer Para 4.26 .

5.8 STORES TO BE SUPPLIED BY RAILTEL.

Refer Para 1.17.

5.9 ENGAGEMENT OF QUALIFIED ENGINEER:

Not used.

5.10 TEST & MEASURING INSTRUMENTS AND SPECIAL TOOLS ETC.

5.10.1 Special tools & instruments required for installation and commissioning of the work as detailed in preamble shall be arranged by contractor at his own cost.

5.10.2 All tests and measuring instruments and other arrangements required for carrying out all the acceptance tests etc shall be provided by the contractor at his own cost.

5.11 STORES TO BE SUPPLIED BY CONTRACTOR

Refer Para 1.18

5.12 SUPPLY OF TECHNICAL LITERATURES, DOCUMENTATION DRAWINGS, INSTRUCTION BOOK & COMPLETION PLANS ETC.

5.12.1 The contractor shall supply complete documentation in Electronic form and Hard Copies. One set of tracings with 3 sets of prints for cable route plans drawn in CAD giving complete details. Necessary corrections as desired shall be done and final tracings should get approved. After completion of work, the As built drawings shall be made indicating OFF sets from center of nearest Railway track and all protective works. The offsets, route markers, joint & coupler's locations shall also be pointed out on OHE mast & any other landmark as per EIC. 3 sets of tracings & six sets of prints along with 3 CDs of as built drawings shall be supplied.

5.12.2 The contractor shall also submit the drawings of protective works like bridges/HDD/track, or Road crossing , LC gate, ROB, RUB , joint pits etc. proposed and being executed at site for approval of RailTel /Railways.

The cable route plan should also contain information regarding important chainages from relevant land mark ,location of jointing chambers, pull through chambers, culverts bridges etc RCC and GI Locations, locations of road crossing/track crossings preferably from two independent reference points.

5.13 SPARES

Deleted.

5.14 LONG TERM AVAILABILITY OF SPARES AND SYSTEM SUPPORT

Deleted.

5.15 QUALITY ASSURANCE

All the materials supplied are technically inspected and accepted by purchase's representatives. In the event of RailTel waving off the inspection, the quality assurance department of the manufacturer shall carry out all the tests as per the specification and issue a certificate indicating clearly the test results and the adherence to the technical specifications. This is without prejudice to the purchaser's right to accept or reject the supplies if not found in conformity to its requirement.

5.16 Not used

5.17 INSPECTION OF MATERIALS

5.17.1 All equipments, materials, fittings and components supplied by the contractor are required to be inspected as per the codes and specifications by the purchaser or his representative before accepting the delivery.

5.17.2 A. The materials which are procured from RDSO approved firms with RDSO specification and if the cost of the material is over Rs. 1 Lakh, the inspection shall be carried out by RDSO. Inspection in respect of order below Rs. 1 Lakh will be got done by Consignee.

B. Inspection of G.I.Pipe shall be carried out by RITES if the cost of it is over Rs. 5 Lakhs. Inspection in respect of order below Rs. 5 Lakh will be got done by Consignee.

5.17.3 All materials shall be procured from the manufacturers of repute/their authorized dealers. Such materials are to be accepted by the Engineer. The contractor may be required to produce test certificate from the manufacturer wherever called for by the Engineer.

5.17.4 The inspection charges, if any, payable to the purchaser's representative for carrying out the inspection shall be borne by the purchaser. However contractor shall pay the inspection charges to the purchaser's representative/agency for carrying out the inspection. Reimbursed will be done by RailTel later based on submission of claim along with documentary proof by contractor as per actual Inspection Charges paid.

5.17.5 The cost of equipment and materials, all tests and / or analysis performed for inspection shall be borne by the contractor.

5.17.6 Following items shall be inspected by Consignee/Authorized representative.

Sr.No	Description of Item	Inspection Agency
1	G.I. Pipe 'Class B' /Medium with fittings and other required material as per specn. No. IS 1239 (part II) with latest amendments, if any.	By 'RITES', if the cost of material above 05 lakhs otherwise it will be done by consignee / Authorized representative of RailTel
2	OFC	By 'RDSO', if the cost of material above 01 lakh otherwise it will be done by consignee / Authorized representative of RailTel
3	HDPE Duct	By 'RDSO', if the cost of material above 01 lakh otherwise it will be done by consignee / Authorized representative of RailTel

All other materials “**Except**” mentioned above shall be inspected by the Consignee

5.17.7 Items of SOR shall be inspected by Authorized representative of RailTel.

5.18 INSPECTION OF WORKS

Method of measurements:

The measurement of the work shall be done for activity wise as and when the item of work is ready for measurement. The methods of measurements of various items are enumerated as under:

Measurement of depth of trenches:

The cable routes of one sub-section shall be divided into a number of segments each of maximum 200 meters length bounded by identifiable landmarks like OHE mast/Chainages etc at both the ends of the segments. If landmarks are not available, length of segment may be maintained at 200 meters. The measurement of depth shall be recorded at each Point Of Measurement (POM) in the site register in meters in the multiples of 5 cms. For example 97 cms will be recorded as 95 cms and 103 cms as 105 cms. The points of measurements shall be at a distance of 10 meters starting from 0 (Zero) Meter, For example, if the length of segment is 75 meters, the POM shall be at 0 M, 10 M, 20 M, 30 M, 40 M, 50 M, 60 M, 70 M. The last POM shall be at 75th M to be recorded against residual POM. Payment shall be made to contractor for a full section 200 meters only i.e. if GI/DWC/RCC Pipes laying, rope pulling, refilling of trench and fixing and concreting of Route marker is complete in all respect. Incomplete or unfinished sections will be recorded in site register, but the final recording in the measurement book and payment shall be released only when section is certified to be complete in all respect by the site in charge. If water drain or road gutter encountered along the road the depth shall be measured from the top surface of the water drain or road gutter. However, payment will not be made for the undug portion in the water drain or road gutter. The efforts required to excavate trenches is not proportionate especially with reference to depth. Therefore, normally the workers tend to dig shallow trenches. As standard depth of the trench is important for future life and protection of cables, this tendency has to be discouraged. In order to encourage the contractor to achieve best possible depth in the face of site constraints, the following scale of payment shall be applied for digging trenches of lesser depths, subjects to condition that relaxation has been granted by the competent authority for lesser depths. Measurement of depth of trenches & payment details on pro-rata basis:

i. For non-rocky soil:

For lesser depth, Trenching will be done as per instruction of EIC and penalty will be imposed as below:

Penalty for Less Depth (Rs.) = [(1.2-Achieved Depth)/1.2]*0.48*Accepted Rate*Qty of Less Depth

ii. For rocky soil:

For lesser depth, Trenching will be done as per instruction of EIC and penalty will be imposed as below:

Penalty for Less Depth (Rs.) = [(0.6-Achieved Depth)/0.6]*0.48*Accepted Rate*Qty of Less Depth

Execution Multiplying Factor of Rate=0.48

Note: This Rate is applicable only where Underground OFC laying is possible. The EIC has to approve such exceptions with reasons for non achieving the desired depth.

Measurement of Lengths and profiles of strata and protection: - The measurements of length of trenches are on running meter basis, irrespective of type of soil encountered while digging. The type of protection provided (item code-wise) in a segment shall be recorded in the site register in the sheet provided for this purpose.

Measurement of length of cable: - The length of cables laid in trenches, through pipes and through ducts shall be measured by use of RODO Meter/Measuring Tape. The length should be cross verified with the marking of lengths on the cables. The lengths shall be recorded in sheet provided in the site register.

Measurement of other items: - The measurement/numerical details of other items shall be recorded in the sheets provided for respective items viz.

- Digging of joint pit and preparation of joint chambers along with its Pre Cast RCC type.
- Fixing, Painting and sign writing of route/joint marker.
- Termination of Cable in equipment room and no. of joints.

The contractor shall sign all the measurement recorded in the site register. The final measurement recorded in the Measurement Book, and signed by the contractor which will consider this as an acceptance. In case contractor fails to attend at the measurements or fails to countersign or to record the difference within a week, than in any such events the measurements taken by Engineering-In-Charge or by the subordinate as the case may be shall be final and binding on the contractor and the contractor shall have no right to dispute the same.

The Engineer-in-charge before passing the bill for sections covered by each set of measurement may carry out test check by re-opening trench at as many locations as necessary as specified in document 'procedures for underground cable construction' and bills will be passed only when he is personally satisfied of the correctness of entries in the "Measurement Book" and also when he is satisfied of other aspects of the work as per the terms of the contract. The contractor shall provide the necessary assistance of labour for reopening of trench for test check. Separate payment shall not be made to the contractor for excavation of such test checks; however such test pits shall not be more than 10% of the cable laying work. Measurement of the work of cable pulling through pipe/duct will be taken equal to the length of the pipe/duct through which the cable has been pulled and not the total length of the cable pulled through pipe/duct.

5.19 QUANTUM OF WORK AND VARIATION IN QUANTITIES

5.19.1 **Modification to contract to be in writing:** In the event of any of the provisions of the contract requiring to be modified after the contract documents have been signed, the modifications shall be made in writing and signed by the RailTel and the Contractor and no work shall proceed under such modifications until this has been done. Any verbal or written arrangement abandoning, modifying, extending, reducing or supplementing the contract or any of the terms thereof shall be deemed conditional and

shall not be binding on the RailTel unless and until the same is incorporated in a formal instrument and signed by the RailTel and the Contractor, and till then the RailTel shall have the right to repudiate such arrangements.

5.19.2 **Powers of modification to contract :** The Engineer on behalf of the RailTel shall be entitled by order in writing to enlarge or extend, diminish or reduce the works or make any alterations in their design, character position, site, quantities, dimensions or in the method of their execution or in the combination and use of materials for the execution thereof or to order any additional work to be done or any works not to be done and the contractor will not be entitled to any compensation for any increase/reduction in the quantities of work but will be paid only for the actual amount of work done and for approved materials supplied against a specific order.

- (i) Unless otherwise specified in the special conditions of the contract, the accepted variation in quantity of each individual item of the contract would be up to 25% of the quantity originally contracted, except in case of foundation work. The contractor shall be bound to carry out the work at the agreed rates and shall not be entitled to any claim or any compensation whatsoever up to the limit of 25% variation in quantity of individual item of works.
- (ii) Quantities operated in excess of 125% of the agreement quantity of the concerned item shall be paid 98% of the rate awarded for that item in this tender.
- (iii) Quantities operated in excess of 140% of but up to 150% of the agreement quantity of the concerned item shall be paid at 96% of the rate awarded for that item in this tender.
- (iv) Variation in quantities of individual items beyond 150% will be executed through fresh tenders or by negotiating with the existing contractor with finance concurrence and approval of competent authority.
- (v) The contract signing authority can decrease the items up to 25% of individual item without finance concurrence.
- (vi) For decrease beyond 25% for individual items, finance concurrence and approval of competent authority shall be taken after obtaining "No Claim Certificate" from the contractor.
- (vii) In case of earthwork, the variation limit of 25% shall apply to the gross quantity of earth work and variation in the quantities of individual classifications of soil shall not be subject to this limit.

5.19.2.3 **Valuation of variations :-** The enlargements, extensions, diminution, reduction, alterations or additions referred to in sub-clause (5.19.2) of this clause shall in no degree affect the validity of the contract but shall be performed by the Contractor as provided therein and be subject to the same conditions, stipulations and obligations as if they had been originally and expressively included and provided for in the specifications and drawings and the amounts to be paid therefore shall be calculated in accordance with the accepted schedule of rates.

NOTE :1 Handling vitiation during Variation in Contract Quantities:

1. Handling Vitiatio during Variation in Contract Quantities In the contract, as a

result of variations, a contract shall be considered “vitiating” only when, the following percentage variation in contract value between tenderers are noticed to have been exceeded.

Sr. No	Value of contract	Percentage difference between present contractor and new L-1 as a result of variation. (Percentage shall be calculated with base as the revised contract quantities multiplied by the rates of the present contractor)
1	Small value contracts (Tender value less than Rs. 50 Lakhs)	10
2	Other than small value contracts (Tender value equal to or more than Rs. 50 Lakhs)	5

1.1 When the percentage difference between present Contractor and new L-1 is noticed as becoming beyond the values specified above, the following action shall be taken.

It should be immediately examined whether it is practicable to bring in a new agency to carry out the extra quantity of work keeping in view the progress of the work in accordance with the original contract and the nature and lay-out of the work. If it is found that there will be no serious practical difficulty in meeting the additional quantity of work done by another agency, then fresh tenders for the extra quantity may be invited otherwise negotiating the rate with the existing contractor for arriving at a reasonable rate for the additional quantities of work, may be adopted.

1.2 **The above shall be regulated as under:**

- a) The case shall be decided by the tender accepting authority (competent for the revised quantity) and shall not be treated as a case of single Tender.
- b) Executives while executing the work shall make all efforts to ensure that no vitiation takes place in normal circumstances, vitiation should be an exception rather than a routine affair. Efforts should be made to invite bids on the basis of percentage above/below/at par.
- c) Vitiation should always be computed with respect to the items, rates, quantities and conditions as available at the time of Tender Opening and subsequent changes/additions by way of new items will not be counted for computing vitiation.

2. **System of Verification of Tenderers credentials:**

2.1 The tenderer shall submit along with the tender document, documents in support of his/their claim to fulfill the eligibility criteria as mentioned in the tender document. Each page of the copy of documents/certificates in support of credentials, submitted by the tenderer, shall be self-attested/digitally signed by the tenderer or authorized representative of the tendering firm. Self-attestation shall include signature, stamp and date (on each page). Only those documents which are

declared explicitly by the tenderer as “documents Supporting the claim of qualifying the laid down eligibility criteria”, will be considered for evaluating his/their tender.

- 2.2 “The tenderers shall submit a notarized affidavit on a non-judicial stamp paper stating that they are not liable to the disqualified and all their statements/documents submitted along with bid are true and factual. Standard format of the affidavit to be submitted by the bidder is enclosed as Form 15.

Non submission of an affidavit by the bidder shall result in summary rejection of his/their bid. And it shall be mandatorily incumbent upon the tenderer to Identify, state and submit the supporting documents duly self-attested by which they/he Is qualifying the Qualifying Criteria mentioned In the Tender Document. It will not be obligatory on the part of the RailTel to scrutinize beyond the submitted document of tenderer as far as his qualification for the tender is concerned”

With the submission of the affidavit as mentioned above, the practice of verification of tenderer’s documents by the RailTel may be dispensed with Following clause may also be added to the Instruction to Bidders.

- a) The RailTel reserves the right to verify all statements, Information and document submitted by the bidder in his tender offer, and the bidder shall, when so required by the RailTel, make available all such Information, evidence and document as may be necessary for such verification. Any such verification or lack of such verification, by the RailTel shall not relieve the bidder of its obligations or liabilities here under nor will it affect any right of the RailTel there under.
- b) In case of any wrong information submitted by the tenderer, the contract shall be terminated, Earnest Money Deposit (EMD), Performance Guarantee (PG) and Security Deposit (SD) of contract forfeited and agency barred for doing business on entire RailTel for 05 (Five) years.

5.20 Not used

5.21 SUBLETTING AND ASSIGNMENT

5.21.1 The contractor may sublet a part of the work under this contract and enter into contract with suppliers for supply of materials. The credentials of subcontractors shall be subjected to scrutiny and approval of RailTel.

5.21.2 The contractor shall arrange for effective supervision of sub contractor’s work and remain solely responsible for materials supplied and for works carried out on his behalf by the sub-contractor.

5.22 EXECUTION OF WORK

All the works shall be executed in strict conformity to the provisions of the contract document and with such explanatory detailed drawings, specifications and instructions as may be approved from time to time based on detailed design and engineering carried out by contractor in line with requirements as per contract document. The contractor shall be responsible for ensuring that the work throughout are executed in the most substantial, proper and workman like manner with the quality of material and workmanship in strict accordance with the specifications and as per sound industrial practices and to the entire satisfaction of the RailTel. **Contractor shall deploy multiple**

teams at various sections to execute work simultaneously and completion of all work in stipulated due timeline.

5.23 Not used

5.24 MAINTENANCE OF WORKS

The contractor shall at all times during the progress and continuance of the works and also for the period of maintenance specified in the tender form and after the date of passing of the certificate of completion by the RailTel 's representative or any other earlier date subsequent to the completion of the works that may be fixed by RailTel 's representative be responsible for and effectively maintain and uphold in good, substantial, sound and perfect condition all and every part of the works and shall make good from time to time and at all times, as often as the RailTel 's representative shall require, any damage or defect that may, during the above period, arise in or be discovered or be in any way connected with the works provided that such damage or defect is not directly caused by errors in the contract documents, act of providence or insurrection or civil riot and the contractor shall be liable for and shall pay and make good to the RailTel or other persons legally entitled thereto whenever required by the RailTel 's representative so to do, all losses, damages, costs and expenses they or any of them may incur or be put or be liable to, by reason or inconsequence of the operations of the contractor or his failure in any respect.

5.25 CLEARANCE OF SITE

At the end of the work at each location the Contractor shall as a part of his Contractual obligation leave the area completely neat and clean.

5.26 PROVISIONAL ACCEPTANCE CERTIFICATE (PAC)

5.26.1 Immediately after the completion of the work of whole section or after completion of work in Zonal Railways/division of sub-section decided by the engineer, the contractor shall certify and advise the RCIL in writing that the installation is (i) complete (ii) ready for satisfactory commercial service and (iii) ready to be handed over.

5.26.2 The test or tests specified in Technical supplement (chapter 7) will be conducted jointly by RCIL and contractor as soon as possible after receipt of advice of completion of one sub - section by RailTel from the contractor. The test schedule shall be finalized by mutual discussion between the contractor and M/s RailTel Corporation of India Limited, Mumbai. Any component, modules, sub assemblies or equipment, losses in OFC failing during the commissioning test shall be replaced/repaired free of cost by tenderer.

5.26.3 Purchaser's Engineer shall issue a Provisional Acceptance Certificate (PAC) for successful commissioning of each subsection covering all materials and services included in the Schedule of works after the final acceptance test as per the approved test procedures have been completed and the performance has been found to meet the specifications. PAC shall not be held up for want of minor deficiency which shall be attended by the contractor within reasonable time to the satisfaction of Engineer. RailTel's decision in this respect shall be final. The Provisional Acceptance Certificate shall be signed by both the parties.

5.27 MAINTENANCE OF WORK TILL ISSUE OF LAST PAC

5.27.1 After the work has been completed & placed in service and Provisional Acceptance certificate issued by Purchaser's Engineer, the contractor shall be responsible for proper maintenance supervision of the work for a period of twelve months from the date of PAC.

For this purpose he shall prepare a maintenance plan and make available the services of qualified maintenance engineer stationed at the location approved by Purchaser's Engineer who will guide and supervise the work of RailTel maintenance staff. The maintenance engineer of the tenderer will visit the total installation at least once in a month.

5.27.2 The Contractor shall inspect all trenches after first monsoon and shrinkage etc. shall be refilled and rammed & trench surface brought to the original. No extra charge shall be payable for the same.

5.27.3 During this period of maintenance supervision if any lacuna is noticed in the functioning, as a result of any work, the contractor free of cost will rectify the same. During such rectification if any faulty equipment/modules need replacement or repair, they shall be provided by the contractor from the set of equipment or modules that the contractor should bring to the site of installation in addition to all the materials to be supplied against this contract. Use of spare modules covered under the Schedule of material of this tender shall not be permitted to be used during installation, commissioning and period of maintenance supervision.

5.27.4 The contractor shall be responsible for proper maintenance of the work at his own cost until PAC for last completed sub-section is issued and work of whole section is completed. During this period, the tenderer shall have to attend any fiber cut etc. which takes place.

5.28 FINAL ACCEPTANCE CERTIFICATE (FAC)

5.28.1 The final acceptance of the works completed in the whole section shall take effect from the date of expiry of the period of warranty as defined in Para 5.29 i.e. on expiry of the warranty period from the date of issue of last Provisional Acceptance Certificates or brought into commercial operation, provided in any case that the contractor has complied fully with his obligations in respect of each item under the contract.

5.28.2 Notwithstanding the issue of Final Acceptance Certificate the contractor and the purchaser (subject to Sub Clause as above) shall remain liable for fulfilment of any obligation incurred under the provision of the contract prior to the issue of Final Acceptance Certificate which remains unperformed at the time such certificate is issued and for determining the nature and extent of such obligation the contract shall be deemed to remain in force between the parties hereto.

5.29 WARRANTY

5.29.1 All equipment /material supplied by the Contractor shall be guaranteed against the defects for a period of 12 months from the date of issue of Provisional Acceptance Certificate for last completed sub section(issue of last PAC). The contractor shall provide comprehensive warranty maintenance for all the items supplied by him against this tender.

5.29.2 Contractor will ensure availability of adequate spares for providing replacement of faulty material , items during the warranty.

5.29.3 If any equipment/material supplied by the contractor becomes defective during the warranty, the same shall be replaced by the contractor and total cost of such replacement shall be borne by the contractor. The replaced material will also be guaranteed for the remaining period of original warranty.

5.30 Training

5.30.1 Deleted

5.30.2 The contractor shall at every stage of installation; testing and commissioning provide all facilities for adequate training of RailTel personnel who may be deputed to work on the project.

5.31 INFRINGEMENT OF PATENTS:

(a) The Contractor is forbidden to use any patents or registered drawings, processes or patterns in fulfilling his contract without prior consent in writing of the owner of such patents, drawings, patterns or trademarks except where these are specified by the Purchaser himself. Royalties where payable for the use of such patented processes, registered drawings or patterns shall be borne exclusively by the Contractor. The Contractor shall advise the Purchaser of any proprietary rights that may exist on such processes, drawings or patterns which he may use of his own accord.

(b) In the case of patents taken out by the Contractor of the drawings or patterns registered by him or of those patents, drawings or patterns for which he holds a license, the signing of the contract automatically gives the Purchaser the right to repair by himself the purchased articles covered by the patent or by any person or body chosen by him and to obtain from any sources he desires the component parts required by him for carrying out the repair work. In the event of infringement of any patent rights due to above action of the Purchaser he shall be entitled to claim damages from the Contractor on the grounds of any loss of any nature which he may suffer e.g. in the case of attachment because of counterfeiting.

5.32 LICENSE AS PER GOVT. OF INDIA CONTRACT LABOUR ACT

The Contractors are required to produce license as enjoined in the Government of India Contract Labour (Regulation and Abolition) Act, 1978 with latest amendments, if any. They shall not be allowed to undertake or execute any work through contract Labour except under and in accordance with a license issued under the said Act in that behalf by the authorized licensing Officer.

5.33 DEFAULTS AND DELAYS

The Contractor shall execute the work with due diligence and expedition, keeping to the approved time schedule. Should he refuse or neglect to comply with any reasonable orders given to him in writing by the Purchaser's Engineers in connection with the work or contravene the provision of the Contract or the progress of work lags persistently behind the time schedule due to his neglect, the Purchaser shall be at liberty to give seven days notice in writing to the Contractor requiring him to make good the neglect or contravention complained of and should the Contractor fail to comply with the requisitions made in the notice within seven days from the receipt thereof, it shall be lawful for the purchaser to take the work wholly or in part

out of the Contractor's hands without any further reference and get the work or any part thereof, as the case may be, completed by other agencies at the expense of the Contractor without prejudice to any other right or remedy of the Purchaser.

5.34 LOSS SUSTAINED DUE TO DEFAULTS AND DELAYS

In the event of any loss to the purchaser on account of execution and/or completion of the work or any part thereof by agencies other than the contractor, in terms of Para 5.33 of the tender document, the contractor shall be liable to reimburse the loss to purchaser without prejudice to the other rights and remedies of the purchaser and the reimbursement in full or in part, as the case may be, shall be met at the option of the purchaser from out of all or any of the following sources via :

- (a) i) Any amount due and payable to the contractor by the purchaser on any account whatsoever;
ii) The Contractor's security deposit in the hands of the purchaser as far as available, and;
iii) Any other assets whatsoever of the contractor;
- (b) In the event of re-imburement from out of sources (I) and/or (ii) above mentioned, the purchaser shall have the right of appropriation sue motto.

5.35 PENALTY FOR DELAY IN COMPLETION

5.35.1 The time for the execution of the work or part of the works specified in the contract documents shall be deemed to be the essence of the contract and the works must be completed not later than the date(s) as specified in the contract. If the contractor fails to complete the works within the time as specified in the contract for the reasons other than the reasons specified in clause 5.48, the RailTel may, if satisfied that the works can be completed by the contractor within reasonable short time thereafter, allow the contractor for further extension of time (Performa Annex. II) as the Engineer may decide. On such extension the RailTel will be entitled without prejudice to any other right and remedy available on that behalf, to recover from the contractor as agreed damages and not by way of penalty a sum equivalent to ½ of 1% of the contract value of the works for each week or part of the week.

For the purpose of this clause, the contract value of the works shall be taken as value of work as per contract agreement including any supplementary work order/contract agreement issued. Provided also, that the total amount of liquidated damages under this condition, shall not exceed the under noted percentage value or of the total value of the item or groups of items of work for which a separate distinct completion period is specified in the contract.

(i) For contract value up to Rs. 2 lacs	10 % of the value of the contract.
(ii) For contract value above Rs. 2 lacs	10% of the 1 st 2 lakh and 5 % of the balance
(iii)The competent authority while granting extension of currency of the contract may also levy token penalty as deemed fit based on the merit of case.	

Provided further, that if the RailTel is not satisfied that the works can be completed by the Contractor and in the event of failure on the part of the contractor to complete the

work within further extension of time allowed as aforesaid, the RailTel shall be entitled without prejudice to any other right or remedy available in that behalf; to appropriate the contractor's security deposit and rescind the contract under 49 of these conditions, whether or not actual damage is caused by such default.

5.35.2 Penalty for cutting/damaging the existing cables of RAILTEL and the existing underground facilities of third parties: -

- (a) During excavation of trench utmost care is to be taken by the contractor so that the existing underground cables are not damaged or cut. In-case any damage/cut is done to the existing cables, a penalty as per the schedule given below will be charged from the contractor or the amount will be deducted from his running bills as per Railway Board's Telecom Circular No.17/2013:-

Size of existing UG/ OFC cut/ damaged	Amount of penalty per cut/ damage
Only Quad cable and signaling cable	Rs. 1.0 Lakhs (Rs. One lakh only)
Only OFC	Rs. 1.25 Lakhs (Rs. One lakh & twenty five thousand only)
Both OFC & Quad	Rs. 1.50 Lakhs (Rs. One lakh & fifty thousand only)
Electrical cable	Rs. 1.0 Lakhs (Rs. One lakh only)

Besides the above penalty, the contractor shall carry out such repairs for restoration of the damaged cable free of charge. The cost of jointing kit shall also be borne by the contractor. If contractor fails to repair the damage, the cost of repair (including cost of labour & jointing kit) shall be recovered from the contractor.

- (b) Contractor shall either pay to third parties all expenditure incurred for restoring services which are damaged by Contractor while carrying out the work or the same amount will be deducted from his bills. Such expenditure shall be intimated to Contractor either by Engineer-In-Charge or concerned third parties in writing. The amount deducted by the Contractor from his bill shall be paid to concerned third parties by Engineer-In-Charge.
- (c) Engineer-in-charge at his absolute discretion shall reserve the right to reject any bill submitted by the Contractor prior to making payment by him to third parties for the damages caused or to deduct same amount from his bill.

- (d) Penalty to damage stores/materials supplied by the RAILTEL while laying:

The contractor while taking delivery of materials supplied by the RAILTEL at the designated place shall thoroughly inspect all items before taking them over. In case of execution of the work, if any material is found damaged/working unsatisfactorily, then a penalty equivalent to the cost of material + 10% as penalty shall be recovered from the contractor's payments/securities.

- (e) However, contractor will not be penalized for any defect in workmanship of the materials, which are directly supplied by RailTel.

5.35.3 If Railways/any other stakeholders of this project imposes any penalty on account of bad workmanship or delays, the same shall be charged to the contractor back to back.

5.35.4 Issue of work order (Not Applicable)

5.36 ADHERENCE OF TIME SCHEDULE

5.36.1 Timely completion of the work is the essence of the contract. While delay in execution will attract penalty.

5.36.2 If any delay as aforesaid in Para 5.35 of tender document shall have arisen from any cause which the Purchaser may agree as being a reasonable ground for extension of time the purchaser's engineer or his representative may allow such additional time as he may in his absolute discretion consider to be reasonably justified by the circumstances of the case. Such extensions shall be granted, on request from contractor, with liquidated damages in the Form No.11.

5.37 CONTRACTOR'S LIABILITIES FOR COSTS AND DAMAGES

Please Refer Para 4.52 of the tender document.

5.38 PRICES

5.38.1 This tender consists of a percentage bidding system. The estimated prices of each and every item of the schedule are indicated in the Schedule of Requirements. The tenderer is expected to quote the %age above(+) / below(-) /at PAR the RailTel's total estimated cost indicated in the schedule.

The percentage above/below/at par finalized for the entire schedule shall be firm and on all-inclusive basis (inclusive all incidental charges for transport, loading/ unloading and handling of materials, commission for arranging dispatch by rail direct from manufacturer's factory and completing all necessary formalities in this respect, such as submission of forwarding notes, arranging placement of Wagon, collection of banker's charges for Bank guarantee, Indemnity Bonds inclusive of cost of Stamp etc., if any, levied by the RailTel).

5.38.2 The prices shall include all taxes, GST and levies applicable on this Contract. Therefore, they should quote their rate taking into account the rate of GST on this work as livable. It is clarified that required form applicable for this purpose will be supplied to the Contractor as applicable in the state where the Contract is being executed.

5.38.3 The rate quoted by the tenderer shall include cost of commissioning and testing and all costs of Administration of Contract, Insurance Premium, Banker's charges for guarantees, cost of storage, loading-unloading and handling of materials and for any road transport which the contractor may use for carriage of materials to his depot and the site of work. The prices shall include the cost of works and adjustments necessary to be done by the contractor during or after tests carried out by the purchaser.

5.38.4 The rate to be quoted by the Tenderers should take into account the credit availed on imports under the CENVAT scheme. The tenderer should give a declaration that any set off in respect of duties on imports as admissible under law is being totally and unconditionally passed on to the purchaser in the price quoted by him (see Para 5.43).

- 5.38.5 While the price quoted in the contract are inclusive of all taxes i.e. GST levied by any statutory authority, the purchaser shall make any deduction toward GST if statutorily required to do so. The deducted GST shall be remitted to the concerned authority and the purchaser shall in no way be responsible for any disputes between the tax authorities and the contractor in this regard.
- 5.38.6 All taxes, duties and levies arising out of the transaction between the contractor and his sub-contractor/supplier for this work will be included in the rates quoted by the contractor in the relevant Schedule.
The rates are all inclusive of taxes but the tenderer has to submit the breakup of all taxes as per Form no 16 annexed with the Tender Document.
- 5.38.7 Arrangement for permits/license for materials will not be made by the RailTel or any assistance given. The Contractor will have to make his own arrangement.
- 5.38.8 As per provision of GST, for all taxable supplies made by the vendor, vendor will issue valid tax invoice in accordance with GST Act in order to enable RailTel to avail input tax credit. For all the taxable supplies made by the vendor, the vendor shall furnish all the details of such taxable supplies in the relevant returns to be filed under GST Act. If the vendor fails to comply with any of the above, the vendor shall pay to purchaser any expense, interest, penalty as applicable under the GST Act.
In case of incorrect reporting of the supply made by the vendor in the relevant return, leading to disallowance of input credit to purchaser, the vendor shall be liable to pay applicable interest under the GST act to the credit of purchaser. The same provisions shall be applicable in case of credit notes.

5.39 MEASUREMENT OF WORKS

- 5.39.1 Refer Para 5.18 of tender document.
- 5.39.2 MEANING AND INTERPRETATION BY RAILTEL TO BE FINAL
All measurement, method of measurement, meaning an intent of specifications provided by purchaser's Engineer shall be final and binding.
- 5.39.3 Measurement of the work for payment will be taken equal to the length of the pipe/duct through which the cable has been pulled and not the total length of the cable pulled through pipe/duct.

5.40 TERMS OF PAYMENT

- 5.40.1.1 On Account Payment:-Ref para 4.46
- 5.40.1.2 Rounding off amounts:-Ref para 4.46
- 5.40.1.3 On account payments not prejudicial to final settlement: -Refer para 4.46
- 5.40.1.4 The vendor should have Registration No. as per provision of GST
- 5.40.2 Manner of payment: - Ref para 4.46.
- 5.40.3 Not Applicable
- 5.40.4 **PROGRESS PAYMENT FOR EXECUTION OF WORK (SCHEDULE OF SERVICES)**
- 5.40.4.1 90% (Ninety percent) of the progress payment for each OFC Patch/Sub-Section of Schedule of Works/Services shall be made after successful completion of Supply, Installation, Testing and Commissioning (SITC) at various locations, joint measurement, testing and handover to the satisfaction of Engineer.

5.40.4.2 5% (Five percent) value of the works/services completed shall be made after the issue of Provisional Acceptance Certificate.

5.40.4.3 Labour Cess shall be deducted from bills as applicable under Liability to pay cess under building and other construction workers welfare Act,1996 and deposited in relevant state where work is being executed.

5.40.4.4 Documents required for passing the payment:

1. Measurement Book (MB)
2. OTDR Reports
3. Route Diagrams
4. On Account Sheet jointly Signed
5. Invoice
6. Material Inspection Certificate
7. Copy of Wages report uploaded on Shramikkalyan portal.
8. Copy of Site Register

5.41 FINAL PAYMENT

5.41.1 Final payment of 5% (five Percent) of contract value shall be made after issue of Final Acceptance Certificate (FAC).

5.41.2 **Post Payment Audit:** Refer clause 4.51.2

5.42 FINAL SETTLEMENT

On expiry of the warranty period and issue of the Final Acceptance Certificate of the entire installations, the security deposit will be refunded to the Contractor after adjustment of any dues payable by the contractor.

5.43 CERTIFICATE FOR CENVAT BENEFITS ON BILLS

- a) The purchaser will not be responsible for payment of taxes and duties paid by the supplier under misapprehensions of law or misclassification and in such cases even if the suppliers bill contain an element of tax or duty which is not payable by the purchaser, such payment would be disallowed.
- b) The claim for GST, if any, on each bill should be supported by the following certificates:-
 - i) Certified that the amount ofclaimed as GST in this bill is in accordance with the provision of the rules in all respects and the same has been actually paid to the GST authorities in respect of the stores covered by the bills.
 - ii) Quarterly certificate to the effect that no refund of GST already reimbursed against this contract has been obtained during the quarter ending. In the event of any such refund being obtained by the seller, the same should be passed on to the purchaser.
 - iii) Certificate: - The tenderers will have to give the following certificates in their offer:-

"We hereby declare that in quoting the above price, we have taken into effect, the full effect of the duty set-off on 'Central excise and counter veiling duties' available under the existing scheme. We further agree to pass

on such additional duties and set off as may become available in future in respect of all the inputs used for the manufacture of the final product, on the date of the supply under scheme, by way of reduction in price and advise the purchaser accordingly.”

- iv) Payment of GST will be released only after submission of GST to authorities and details given in return for GST.

5.44 DEDUCTION FROM ON ACCOUNT PAYMENT BILLS

- (i) All costs, damages or expenses, which RailTel may have been paid or incurred which under the provisions of contract are Contractor's obligations will be deducted by RailTel from progress payment Bills/Invoice of Contractor, as and when it is understood that such an expense has been incurred or paid for.
- (ii) All such claims of RailTel shall, however, be duly supported by appropriate and certified vouchers, receipts or explanations as are available to enable the Contractor to identify such claims.

5.45 TAXES

5.45.1 The Contractor and all personnel employed by him shall pay such taxes like Income Tax as are payable under statutory laws of India and the Purchaser **WILL NOT ACCEPT** any liability for the same.

5.45.2 Deduction of Income Tax at source as per provisions of Finance Act and Income Tax in force shall be made from the Contractor/Sub-Contractor and the amount so deducted may be credited to the Central Government.

5.45.3 Wherever the law makes it statutory for the Purchaser to deduct any amount towards GST on Works, the same will be deducted and remitted to the concerned authority.

5.45.4 Any change in statutory duties/taxes, imposition/removal of any duty taxes shall be to RailTel account.

5.45.5 In case the successful tenderer is not liable to be registered under CGST/IGST/UGST/SGST Act, the RCIL shall deduct the applicable GST from his / their bill under RCM and deposit the same to concerned Authority.

5.45.6 Any statutory revision/variation in taxes /duties shall be to the RailTel's account and shall be admissible on the production of valid documentary evidence. For this tenderer shall submit the taxes/duties structure considered by him while quoting the rates.

5.45.6 GST related clauses W.E.F 01.07.2017

1. The price quoted in the offer should be firm, fixed indicating the breakup and inclusive of, all taxes & duties like import, custom, Anti-Dumping, CGST, SGST, IGST, UTGST etc the offer should be inclusive of packing, forwarding, freight up to destination, insurance charges.
2. Bidder shall issue valid invoice to RailTel for availing proper credit of CGST/ case of award of Contract GST will not be reimbursed in the absence of valid tax invoice.
3. For all the taxable supplies made by the vendor, the vendor shall furnish all the details of such taxable supplies in the relevant returns to be filed under GST Act.
4. If the vendor fails to comply with any of the above, the vendor shall pay to purchaser any expense, interest penalty as applicable under the GST Act

5. In case of incorrect reporting of the supply made by the vendor in the relevant return, leading to disallowance of input credit to purchaser, the vendor shall be liable to pay applicable interest under the GST Act to the credit of purchaser. The same provisions shall be applicable in case of debit/credit notes
6. Tenderer shall quote all inclusive rates, but there shall be break up of basic price and all type of applicable taxes such as SGST/CGST/IGST/UT GST along with respective HSN/SAC Code under GST Law (Including tax under reverse charges payable by the recipient).
7. Wherever the law makes it statutory For the Purchaser to deduct any amount towards GST at sources, the same will be deducted and remitted to the concerned authority.
8. In regards to works contract, the tenderer should have registration no. for GST in respective state where work to be executed and shall furnish GST registration certificate along with tender.
9. The imposition of any new tax and/or increase/in the aforesaid taxes, duties levies, after the last stipulated date for the receipt of tender including extensions if any and the bidder there upon necessarily and properly pays such taxes/ levies/ cess, the bidder shall be reimbursed the amount so paid provided such payments if any, is not, in the opinion of RailTel attributable to delay in execution of work within the control of bidder. The bidder shall, within a period of 30 days of the imposition of any such tax or levy or cess, give a written notice thereof to Rail Tel that the same is given pursuant to this condition, together with all necessary information including details of input credit relating thereto. In the event of non-payment/default in payment of any of the above taxes. RailTel reserves the right to with-hold the dues/ payment of bidder and make payment to state/Central Government authorities as may be applicable. However if the rates are reduced after the last stipulated date for receipt of tender, bidder has to pass on the benefits to RailTel.
10. **Incase of imported equipment :**
Anti-Dumping duty if applicable on the equipment proposed to be supplied by OEM/ Tenderer as per extant instructions of Ministry of Commerce/Finance Government of India has to be borne by the tenderer and shall be deducted from the amount payable to the bidder at the, time of making payment to the firm. if this duty amount is paid to Custom Authority by RailTel.
11. **Evaluation Criteria:**
Inter se position of the offers will be determined on total unit rate on CIP destination basis which will include basic rate, custom duty, CGST, SGST, IGST, GST, freight, insurance and any other charge or cost quoted by the tenderer, including GST payable. On reverse charge by RailTel, wherever applicable.

5.46 MOBILIZATION ADVANCE

No mobilization advance will be given to the contractor.

5.47 INSURANCE

- 5.47.1 The Contractor shall take out and keep in force a policy or policies of insurance against all liabilities of the Contractor or the Purchaser at common law or under any statute in respect of accidents to persons who shall be employed by the contractor in or about the site for the purpose of carrying out the works on the site. The Contractor shall also take out and keep in force a policy or policies of Insurance against all recognized risks to their offices and depots. Such insurance shall in all respects be to the approval of the Purchaser and if he so requires in his name.

5.47.2 **INSURANCE OF MATERIALS & INSTALLATIONS**

The Contractor shall take out and keep in force a Policy or policies of Insurance for all materials including materials/ equipments supplied by RailTel irrespective of whether used up in the portion of work already done or kept for the use in the balance portion of the work until such works are provisionally handed over to the RailTel. For this purpose, the works are deemed to have been provisionally handed over when provisional acceptance certificate is issued for the locations.

5.47.3 The Contractor shall not be liable for losses/damages to the materials either used up in the portion of work done or his material kept for use at site, in consequence of Mutiny, or other similar causes over which the Contractor has no control and which cannot be insured. Such losses or damages shall be the liability of the Purchaser and if required by the Purchaser, be made good by the contractor at the cost of the Purchaser.

5.47.4 The Contractor should, however, insure the stores brought to site, against risks in consequence of war and invasion, as required under the Emergency Risk (Goods) Insurance Act enforce from time to time.

5.47.5 It may be noted that the beneficiary of the insurance policy should be RailTel or the policies should be pledged in favor of RailTel. The contractor shall keep the policy / policies current till the installations are provisionally handed over to the purchaser. It may also be noted that in the event of contractor's failure to keep the policy current and alive, renewal of policy will be done by purchaser for which the cost of the premium plus 20% of premium shall be recovered from the contractor.

5.47.6 For the purpose of enabling the contractor to take the insurance cover in connection with this contract, the purchaser's Engineer will advise the approximate price of all the RailTel supply materials to the Contractor.

5.48 **FORCE MAJEURE CLAUSE**

Refer para 4.11 of chapter -4

5.48.1 Refer para 4.17 of chapter-4

5.49 **SETTLEMENT OF DISPUTE AND ARBITRATION**

- (1) **Right of RailTel to determine the contract:** - The RailTel shall be entitled to determine and terminate the contract at any time should, in the RailTel's opinion, the cessation of work becomes necessary owing to paucity of funds or from any other cause whatever, in which case the value of approved materials at site and of work done to date by the Contractor will be paid for in full at the rate specified in the contract. Notice in writing from the RailTel of such determination and the reasons therefore shall be conclusive evidence thereof.
- (2) **Payment on determination of contract:** - Should the contract be determined under sub Para 5.49(1) of tender document of this clause and the Contractor claims payment for expenditure incurred by him in the expectation of completing the whole of the work, the RailTel shall admit and consider such claims as are deemed reasonable and are supported by vouchers to the satisfaction of the Engineer. The RailTel's decision on the necessity and propriety of such expenditure shall be final and conclusive.
- (3) The Contractor shall have no claim to any payment of compensation or otherwise. Howsoever on account of any profit or advantage which he might have derived from the execution of the work in full but which he did not derive in consequence of determination of contract.

(4) Arbitration:-

- (a) Any dispute or differences of any kind whatever arising in connection with the Contract or the carrying out of the works (whether during the progress of the works or after their completion and whether before or after the determination, abandoned or breach of the Contract) shall be referred to and settled by the sole arbitrator in accordance with the provisions contained in arbitration and conciliation Act, 1996.
- (b) The sole arbitrator shall be appointed by the CMD of RailTel Corporation of India Limited. It is expressly understood between the parties that no objection shall be raised at time after execution hereof to the appointment of the arbitrator by the MD of RailTel Corporation of India Limited including that the person appointing the arbitrator is connected to and / or employed with RailTel Corporation of India Limited.
- (c) The venue of the arbitration shall be New Delhi (India). The arbitration proceedings shall be conducted in English and the cost of the arbitration shall be borne between the parties in equal proportion.
- (d) The arbitrator shall give a reasoned award, which shall be binding on the parties.

रेलटेल
RAILTEL

A Government of India
Undertaking

CHAPTER – 6

FORMS OF TENDER

Form No. 1	:	Offer Letter
Form No. 2	:	Qualifying Criteria / User's Certificate
Form No. 3	:	Agreement
Form No. 4	:	Proforma for Performance Bank Guarantee
Form No. 5	:	Statement of Deviations
Form No. 6	:	Standing Indemnity Bond (for on Accounts Payments and Stores Supplied by RailTel)
Form No. 7	:	System performance guarantee.
Form No. 8	:	Not used
Form No. 9	:	Works in hand
Form No. 10	:	Acknowledgement of receipt of materials from RailTel
Form No. 11	:	Extension of period of completion of work on Contractor's Account
Form No. 12	:	Not used
Form No. 13	:	Qualification Experience
Form No. 14	:	RTGS format.
Form No. 15	:	Format for Affidavit to be submitted by Tenderer alongwith Tender Documents
Form No. 16	:	Tax Breakup

रेलटेल
RAILTEL

A Government of India
Undertaking

Form No.1

OFFER LETTER

From:

Date:

To:

Principal Executive Director,
RailTel Corporation of India Limited,
Western Region,
Mumbai.

Sub: Supply, Installation, Trenching/HDD/Clamping, Laying of Duct, Blowing of OFC through Ducts, Splicing, Testing & Commissioning for OFC Patch Replacement at various sections of Mumbai Territory of Western Region.

Ref: E-Tender No. RailTel/WR/E-Tender/OT/2023-24/OFC Patch Replacement/01R-2
dated: 21.03.2024

I/We the undersigned hereby offer to execute the agreement for the above work within fifteen days from the date of issue of letter of acceptance of the tender in strict compliance within the provision detailed in the tender paper attached.

I/We agree that this tender shall not be restricted or withdrawn and shall remain opened for acceptance for and during the period of 60 days from the date of opening of the tender.

I/We fully understand the terms and conditions as contained in the tender paper and we agree that the same shall apply to My/Our tender and I/We shall be bound by them.

Earnest money deposit & Tender document cost details are as follows :-

Tender document cost :-

Earnest Money Deposit (EMD) :-

The full value of the Earnest Money shall be forfeited without prejudice to any other right or remedies if:

- (i) If we do not submit the Performance Bank Guarantee/Security Deposit in the event the LOA for any section is awarded to us, within stipulated time.
- (ii) I/We do not execute the contract document within 7 days after the receipt of notice by the RailTel Corporation that such documents are ready.
- (iii) I/We do not commence work within 7 Days from the date of issue of letter of acceptance or as per Clause 4.19 of the contract document.

(iv) If we withdraw our offer after opening of the tender.

(v) If we do not accept the order in the event the same is awarded to us.

Until a formal agreement is prepared and executed, submission of this offer letter shall constitute a binding contract between us subject to modification as may be mutually agreed to between us and indicated in the letter of acceptance of my/our offer.

I/We hereby agree to execute the work and place our teams as required, within the scheduled date mentioned above. In the event of shortcomings in the provision of equipment / placement of team within the stipulated date, RailTel shall be at liberty to impose penalty, if any, as has been stipulated in the tender document.

Yours Sincerely,

Signature & Seal of the Tenderer

Place: -

Date: -

Witnessed by:

1. Signature:

Name:

Address:

2. Signature:

Name:

Address:

रेलटेल
RAILTEL

A Government of India
Undertaking

Form No. 2

QUALIFYING CRITERIA (For Tender amounting more than 50 lakh Rupees)

USER'S CERTIFICATE

Name of the Firm	
Contract No. & date	
Scope of Work	
Contract Amount (in Indian Rupees)	
Completion Period as per original contract	
Completion Period with extension	
Date of Commencement	
Actual date of Successful Completion	

Designation : Name :
Dated :

Signature of the Contractor with
Company Seal

Note: The relevant User's certificate to be attached.

RAILTEL
A Government of India
Undertaking

Form No. 3

AGREEMENT

CA No. _____ for “Name of work:- _____” This AGREEMENT is made this _____ day of _____ Year, by and between RailTel Corporation of India Limited. (A Govt. of India Undertaking) having its Registered office at Plate-A, 6th Floor, Office Block, Tower-2, East Kidwai Nagar, New Delhi-110023, and Regional Office at Western Railway Microwave Complex, opposite Ambika Mills, Senapati Bapat Marg, Mahalaxmi (West), Mumbai-400013 acting in the premises through Executive Director /Western Region (hereinafter referred to as ‘RailTel’, which expression should unless repugnant to the context or meaning thereof include its successors and permitted assigns) of the one part;

And _____ having its Registered office at _____ acting in the premises through _____ (hereafter referred to as “Contractor”, which expression should unless repugnant to the context or meaning thereof include its successor and permitted assigns) of the other part.

Whereas in response to a call for Tender by RailTel for the work of Supply, Installation, Trenching/HDD/Clamping, Laying of Duct, Blowing of OFC through Ducts, Splicing, Testing & Commissioning for OFC Patch Replacement at various sections of Mumbai Territory of Western Region. at Annexure ‘A’ read with Corrigendum..... Issued by RailTel hereto, the Contractor has submitted a Tender as per Annexure ‘B’ hereto

AND WHEREAS the said Tender of the Contractor has been accepted for the work of “_____” as per copy of Letter of Acceptance of Tender No. _____. complete with enclosures at the accepted rates and agreed deviations from tender papers as per Annexure-C hereto at contract value of ` _____ (Rupees _____ Only) duly accepted by the contractor.

Now this agreement witnesses that in consideration of the premises and the payment to be made by the Purchaser (RailTel) to the Contractor provided for herein, the Contractor shall supply all equipment and materials and execute and perform all works for which the said Tender of the Contractor has been accepted strictly according to the various provisions in Annexure ‘B’ and ‘C’ hereto and upon such supply, execute and performance to the satisfaction of the purchaser (RailTel) and the purchaser (RailTel) shall pay to the Contractor at the rates accepted as per the said Annexure ‘C’ and in terms of the provisions therein.

IN WITNESS whereof both the parties have hereunto set and subscribed their respective hands and/or seals on the day and year respectively mentioned against their respective signatures.

Signed and delivered by Shri _____ for and on behalf of RailTel Corporation of India Ltd.

The contract within named in the presence of:

1. Signature :
Date :
Name in Block Capitals :
Address :

2. Signature :
Date :
Name in Block Capitals :
Address :

Signed and delivered by Shri. _____ for and on behalf of
_____, the contractor within named in the presence of :

1. Signature :
Date :
Name in Block Capitals :
Address :

2. Signature :
Date :
Name in Block Capitals :
Address :

Annexure – A : Tender Paper No. _____ with corrigendum, if any.
Annexure – B : Firm's offer.
Annexure – C : Letter of Acceptance No. _____ with all enclosures.
Annexure – D : Copy of Contract Performance Guarantee.

रेलटेल
RAILTEL

A Government of India
Undertaking

Form No. 4

Proforma for Performance Bank Guarantee

PERFORMANCE BANK GURANTEE BOND

(On Stamp Paper of Rs. One Hundred)

(To be used by approved Scheduled Banks)

1. In consideration of the RailTel Corporation of India Limited: Plate-A, 6th Floor, Office Block, Tower-2, East Kidwai Nagar, New Delhi-110023 and Regional office at RailTel Corporation of India Ltd, Address of Regional office..... (herein after called “the RailTel”) having agreed to exempt (Hereinafter called “the said Contractor(s)”) from the demand, under the terms and conditions of an Agreement No. dated made between and for (hereinafter called “the said Agreement”) of security deposit for the due fulfillment by the said Contractor (s) of the terms and conditions contained in the said Agreement, or production of a Bank Guarantee for Rs. (Rs. only). We,(indicate the name of the Bank) hereinafter referred to as “the Bank”) at the request of Contractor(s) do hereby undertake to pay the RailTel an amount not exceeding Rs. Against any loss or damage caused to or suffered or would be caused to or suffered by the RailTel by reason of any breach by the said Contractor(s) of any of the terms or conditions contained in the said Agreement.
2. We, Bank **and our local branch at** (indicate detail address of local Branch with code no.) do hereby undertake to pay the amounts due and payable under this Guarantee without any demur, merely on demand from the RailTel stating that the amount is claimed is due by way of loss or damage caused to or would be caused to or suffered by the RailTel by reason of breach by the said Contractor(s) of any of terms or conditions contained in the said Agreement or by reason of the Contractor(s) failure to perform the said Agreement. Any such demand made on the Bank shall be conclusive as regards the amount due and payable by the Bank under this guarantee. However, our liability under this guarantee shall be restricted to an amount not exceeding Rs.
3. We, bank undertake to pay to the RailTel any money so demanded notwithstanding any dispute or disputes raised by the Contractor(s) / Supplier(s) in any suit or proceedings pending before any court or Tribunal relating thereto our liability under this present being, absolute and unequivocal.
4. The payment so made by us under this Bond shall be a valid discharge of our liability for payment there under and the Contractor(s) / Supplier(s) shall have no claim against us for making such payment.
5. We, Bank further agree that the Guarantee herein contained shall remain in full force and effect during the period that would be taken for the performance of the said Agreement and that it shall continue to be enforceable till all the dues of the RailTel under or by virtue of the said Agreement have

STATEMENT OF DEVIATIONS

PROFORMA FOR STATEMENT OF DEVIATIONS

1. The following are the particulars of deviations from Preamble, requirement of the Instructions to Tenderers and Conditions of Tendering and Special conditions of Contract.

Preamble (Chapter 1)

<u>Clause</u>	<u>Deviation</u>	<u>Remarks (including justification)</u>
---------------	------------------	--

Instructions to Tenderers and Conditions of Tendering (Chapter 3)

<u>Clause</u>	<u>Deviation</u>	<u>Remarks (including justification)</u>
---------------	------------------	--

Special Conditions of Contract (Chapter 5)

<u>Clause</u>	<u>Deviation</u>	<u>Remarks (including justification)</u>
---------------	------------------	--

2. The following are the particulars of deviations from requirement of the **Technical specifications (Chapter 7)**

<u>Clause</u>	<u>Deviation</u>	<u>Remarks (including justification)</u>
---------------	------------------	--

Note: Where there is no deviation, the statement should be returned duly signed with an endorsement indicating “no deviations”.

SIGNATURE AND SEAL OF
TENDERER

RAILTEL

A Government of India
Undertaking

STANDING INDEMNITY BOND

(For on Account Payments and Stores supplied by RailTel)
(On Stamp paper of Requisite Value)

We, M/s _____ hereby undertake that we hold at our Stores Depot/s at _____ for and on behalf of RailTel Corporation of India Limited in the premises through Executive Director or his successor hereinafter referred to as "the Purchaser" all materials for which 'On Account' payments have been made to us against the Contract for ----- vide letter of Acceptance of Tender No. _____ and the materials handed over to us by the Purchaser for all purpose of execution of the said Contract, until such time the materials are duly erected or otherwise handed over to him.

We shall be entirely responsible for the safe custody and protection of said materials against all risk till they are duly delivered as erected equipment to the purchaser or as he may direct otherwise and shall indemnify the Purchaser against any loss, damage or deterioration whatsoever in respect of the said materials while in our possession and against disposal of surplus materials. The said materials shall at all times be open to inspection by any engineer authorized by the Director / Projects (whose address will be intimated in due course).

Should any loss, damage or deterioration of materials occur or surplus materials disposed off and refund becomes due, the purchaser shall be entitled to recover from us the full cost as per prices included in the Contract (as applicable) and also compensation for such loss or damage, if any, along with the amount to be refunded without prejudice to any other remedies available to his by deduction from any sum due or any sum which at any time hereafter becomes due to us under the said or any other Contract.

Dated this _____ day of _____ 2021

for and on behalf of
M/s _____ (Contractor)

Signature of witness

Name and witness in Block letters

Address

रेलटेल
RAILTEL
A Government of India
Undertaking

Form No. 7

SYSTEM PERFORMANCE GUARANTEE

PROFORMA FOR THE SYSTEM PERFORMANCE GUARANTEE

To

The Principal Executive Director/RCIL, Mumbai

I / We hereby guarantee that the design on the basis of which we have submitted our Tender No. _____; has been carefully made to conform to the end objectives in the tender documents and to technical specification therein. We further guarantee that in the event of the performance of the system, when installed, not complying with the end objectives or with the specifications contained in the tender documents, we shall provide further inputs to enable the RailTel to realize the end objectives contained in these documents without any additional payment for any additional equipment which may be required in this regard. We further guarantee that all the expenses for providing the additional inputs under the System Guarantee will be borne by us. We further guarantee that these additional inputs will be provided by us to make the system workable within 1 month from the date on which this guarantee is invoked by the Purchaser. The guarantee is valid for a period of one year from the date of commissioning of the system.

(Signature of Firm's Authorized Officer)

Seal

Signature of witness:

1.

2.



A Government of India
Undertaking

Form No. 9

WORKS IN HAND (For Tender amounting more than 50 lakhs Rupees)

Sr. No	System & Name of the Project	Party's name & address for whom the work is being done	Total Contract Value (₹)	Schedule period of execution (in months)	%age progress in terms of work already done	Likely date of completion	No. of extensions granted	Payments received till date (₹)	Re-marks

Form No. 10

**ACKNOWLEDGMENT
FOR RECEIVING MATERIALS FROM RAILTEL**

Station:

Date:

Sub: Receipt of Material from RailTel

It is hereby acknowledged that the following materials have been received in full and good condition by me on at for the work under the Agreement no. dated

Sr. No.	Description of Material (Meter/No.)	Quantity if any	Remarks
---------	--	--------------------	---------

Witnessed by:

(Signature of Engineer's
Representative with
Designation)

(Signature of Contractor
or Contractor's
Representative)

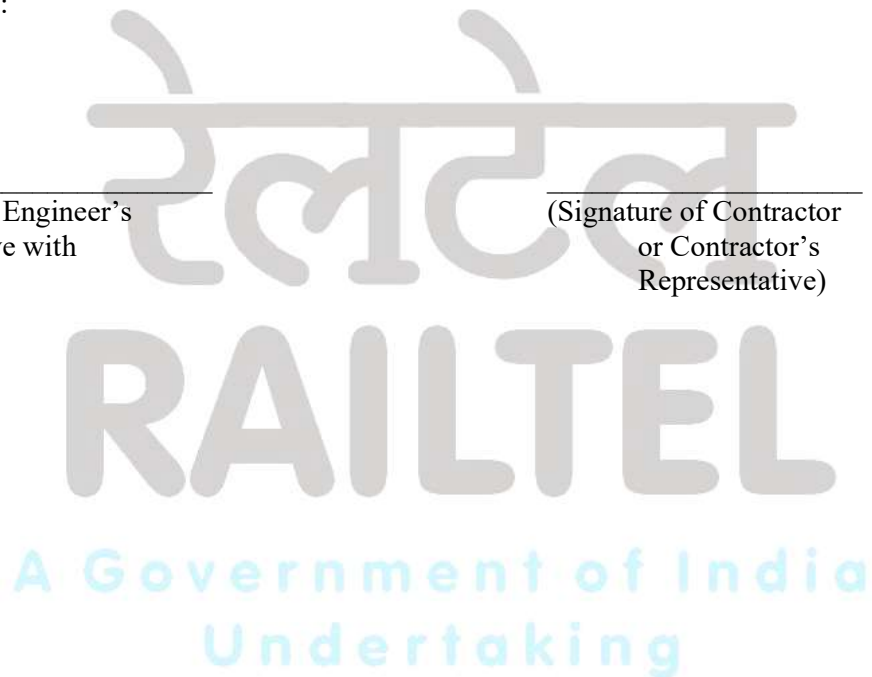

Form No. 11

**EXTENSION OF PERIOD OF COMPLETION OF WORK
ON CONTRACTOR'S ACCOUNT**

No.

Date:

To,

.....

.....

Sub: (i) (Name of Work)
(ii) Acceptance Letter No.
(iii) Undertaking / Agreement No.

Ref:(Quote specific application of the Contractor for extension to date, if received).

Dear Sir,

The stipulated date for completion of the work mentioned above isfrom the progress made so far and the present rate of progress, it is unlikely that the work will be completed by the above date (or However, the work was not completed on this date)

Expecting that you may be able to complete the work if some time is by given the Principal Executive Director, RailTel Corporation of India Limited, Mumbai although not bound to do so, hereby extends the time for completion from to

Please note that an amount equal to 0.5% of the total value of the contract per week or part thereof (rounded off to the nearest whole number) subject to a maximum of 10% of the total contract value of the works as a recovery for delay in the completion of the work after the expiry of (1) will be recovered from as mentioned in Para 5.35 of the special conditions of contract for the extended period notwithstanding the grant of this extension. You may proceed with the work accordingly.

The above extension of the completion date will also be subject to the further condition that no increase in rates on any account will be payable to you.

Please intimate within a week of the receipt of this letter your acceptance of the extension on the conditions stated above.

Please note that in the event of declining to accept the extension on the above said conditions or, in the event of your failure after accepting or acting up to this extension to complete the work by (2)here mention the extended date), further action will be taken in terms of relevant Para of special conditions of contract.

Yours faithfully,
For& on behalf of RailTel Corporation of India Limited

Note:

1. Give here the stipulated date for completion without any penalty fixed earlier.
2. Here mention the extended date.

Sub: (i) (Name of Work)
(i) Acceptance Letter No.



रेलटेल
RAILTEL

A Government of India
Undertaking

Form No. 13

QUALIFICATION & EXPERIENCE (For Tender amounting more than 50 lakhs Rupees)

Details of works executed and under execution by Tenderer during the last 3 years (current year and last three financial years) should be furnished in the following format.

Sl No	Name of Project & Description of work	Party's name & address for whom the work was done	Total Value of the Contract (Rs)	Date of award of work and schedule period of execution (in months)	Date of completion and actual period of execution (in months)	Total contractual payment received	Remarks

Note: A certificate from the organization for whom the work was executed should be submitted to indicate that the contract was satisfactorily executed.

(Signature and Seal of the Manufacturer/Contractor)

रेलटेल
RAILTEL
A Government of India
Undertaking

Form No. 14

**The Joint General Manager (Finance)
RailTel Corporation of India Ltd. (Regional Office)
Western Railway Microwave Complex,
Senapati Bapat Marg,
Mahalaxmi, Mumbai – 400 013.**

Sub. : Option for Payment through RTGS/NEFT

Sir,

You are requested to remit the payment due to us through RTGS/NEFT into our Current Account. The detail required duly verified by our bank for Online payment is provided here under for needful please.

DETAIL REQUIRED FOR PAYMENT THROUGH RTGS/NEFT

1.	Beneficiary Name :	M/s
2.	Beneficiary Address :	
3.	PAN No.	
4.	GSTIN (list)	
5.	Bank A/c No. :	
6.	Name of Bank :	
7.	Bank Branch Address:	
8.	Branch Id Code :	
9.	Current Account No.	
10.	RTGS / IFSC Code :	
11.	NEFT/ IFSC Code :	
12.	MICR no.	

I do hereby declare that the particulars given above are correct and complete. If the transaction is delayed or not effected at all for reasons of incomplete or incorrect information, RailTel will not be held responsible. Further, I undertake that till we request a change, paying authority may kindly continue to make the payments in our account as per above detail.

For
Particulars for Online payments

Verified above Bank

**Authorized Signatory
Signatory**

Bank's Authorized

RAILTEL
A Government of India
Undertaking

FORMAT FOR AFFIDAVIT TO BE SUBMITTED BY TENDERER ALONGWITH THE TENDER DOCUMENTS

(To be executed in presence of Public notary on non-judicial stamp paper of the value of Rs. 100/-. The paper has to be in the name of the tenderer)**

I(Name and designation)*" appointed as the attorney/authorized signatory of the tenderer (including its constituents), M/s _____ (hereinafter called the tenderer) for the purpose of the Tender documents for the work of _____ as per the tender No. _____ of (_____ **RCIL**), do hereby solemnly affirm and state on the behalf of the tenderer including its constituents as under:

1. I/we the tenderer (s), am/are signing this document after carefully reading the contents.
2. I/we the tenderer(s) also accept all the conditions of the tender and have signed all the pages in confirmation thereof.
3. I/we hereby declare that I/we have downloaded the tender documents from RailTel's website www.railtelindia.com or www.ireps.gov.in. I/we have verified the content of the document from the website and there is no addition, no deletion or no alternation in the content of the Tender document. In case of any discrepancy noticed at any stage i.e. evaluation of tenders, execution of work or final payment of the contract, the master copy available with the RailTel Administration shall be final and binding upon me/us.
4. I/we declare and certify that I/we have not made any misleading or false representation in the forms, statements and attachments in proof of the qualification requirements
5. I/we also understand that my/our offer will be evaluated based on the documents/credentials submitted along with the offer and same shall be binding upon me/us.
6. I/we declare that the information and documents submitted along with the tender by me/us are correct and I/we are fully responsible for the correctness of the information and documents, submitted by us.
7. I/we undersigned that if the certificates regarding eligibility criteria submitted by us are found to be forged/false or incorrect at any time during process for evaluation of tenders, it shall lead to forfeiture of the tender EMD besides banning of business for five years on entire **RCIL**. Further, I/we (name of the tenderer)** _____ and all my/our constituents understand that my/our offer shall be summarily rejected.
8. I/we also understand that if the certificates submitted by us are found to be false/forged or incorrect at any time after the award of the contract, it will read to termination of the contract, along with forfeiture of EMD/SD and performance guarantee besides any other action provided in the contract including banning of business for five years on entire **RCIL**.

DEPONENT SEAL AND SIGNATURE OF THE TENDERER

VERIFICATION

I/we above named tender do hereby solemnly affirm and verify that the contents of my/our above affidavit are true and correct. Nothing has been concealed and no part of it is false.

TENDERER

DEPONENT SEAL AND SIGNATURE OF THE

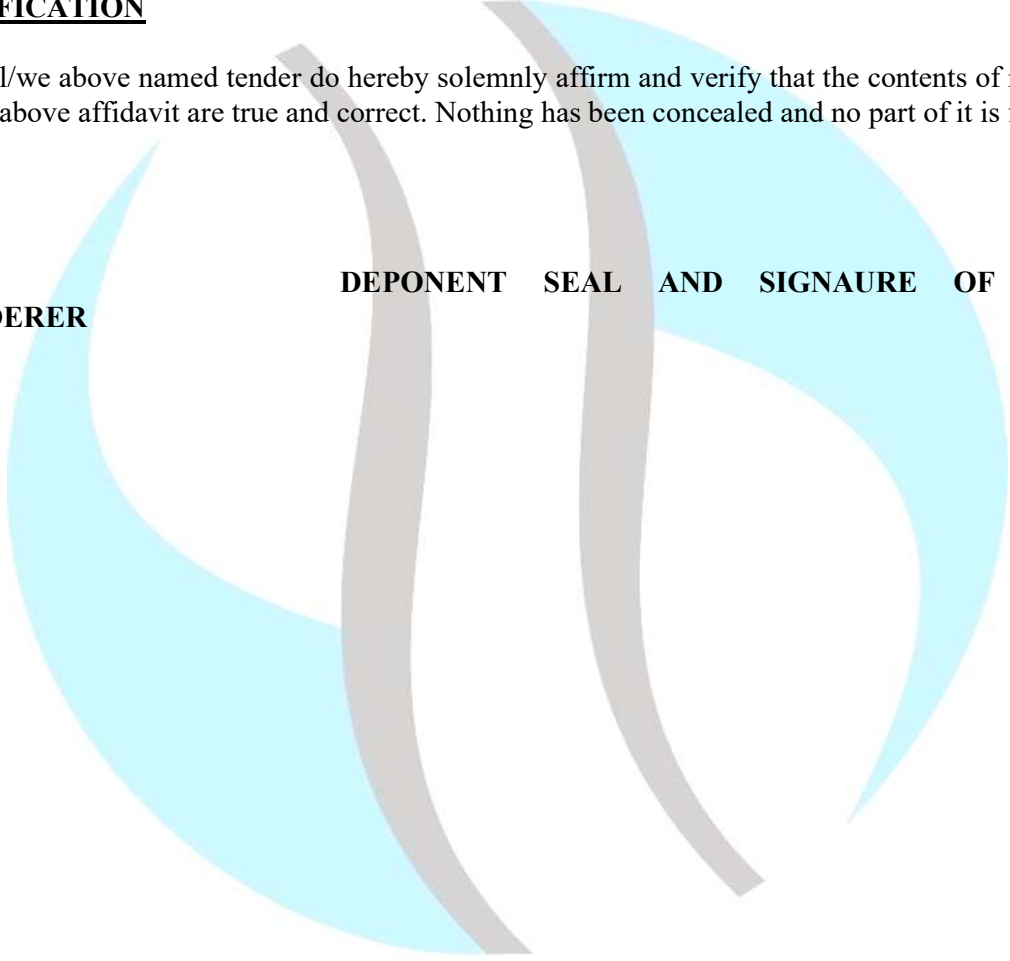

रेलटेल
RAILTEL

A Government of India
Undertaking

Form No. 16

TAX BREAK UP

S.N.	Item description	Unit	Quantity	Base price Rs.	GST %	Any other Tax %	Unit price including Tax	Total Cost Rs

TIN No.
PAN No.
GST No.

Signature and Seal of tenderer

रेलटेल
RAILTEL

A Government of India
Undertaking

CHAPTER-7

TECHNICAL SPECIFICATION AND INSTRUCTIONS

Para No.	Subject
7.1	Scope
7.2	Deleted
7.3	Deleted
7.4	General
7.5	Excavation of Trenches
7.6	Laying of PLB HDPE Ducts
7.7	Back filling and dressing of trench
7.8	Blowing of cable
7.9	Pre cast RCC chamber
7.10	Fixing of route indicators/joint indicators
7.11	Documentations
7.12	Safety precautions
7.13	Allied Activities
7.14	Techniques for Jointing of Fiber Optic Cable
7.15	Isolation of armour of OFC cable
7.16	Acceptance test for Fiber Optic cable
7.17	Test protocol for optical fiber cable
7.18	Tools and Equipment, required for jointing and Termination of Fibre Optic cable

Engineering Instructions

7.1 SCOPE

7.1.1 The Engineering Instructions spelt out in this document deal with the methods to be adopted for underground Optical Fiber Cable laying in PLB HDPE ducts and inter connection of the existing Optical Fiber Cables with the newly laid OF cables and termination of Optical Fiber Cables at OFC hut as per the requirement

7.2 and 7.3 deleted.

7.4 GENERAL

7.4.1 Soil Classification

Soil shall be classified under two broad categories Rocky and Non Rocky, The soil is categorized as rocky if the cable trench cannot be dug without blasting and / of chiseling. All other types of soils shall be categorized as Non Rocky including Murrum & soil mixed with stone or soft rock.

1. Rocky soil : Not Applicable

2. Non Rocky soils

This will include all types of soil- soft soil/hard soil/ murrum i.e. any strata, such as sand, gravel, loam, clay, mud, black cotton murrum, shingle, river or nallah bed boulders, soling of roads, paths, macadam surface of any description (water bound, grouted tarmac etc), CC roads and pavements, bituminous roads, bridges, culverts, etc, other than the rocky soil as stated above.

The Optical Fiber Cable shall be laid through PLB HDPE Ducts buried at a nominal depth of 120 cms in non rocky and 60 cms in rocky soil respectively The steps involved in OF Cable construction are as under

7.4.2.1 Excavation of trench upto a nominal depth of 120 cms. **in non-Rocky soil**, according to construction specifications along railway track /roads and in built up. Under exceptional conditions/ genuine circumstances due to site constraints/ soil conditions, relaxation can be granted by the competent authority for excavation of trench to a depth lesser than 120 cm and prorata payment will be provide for the trenching and back filling as per clause 5.18.

7.4.2.2 Laying of PLB HDPE Ducts/coils coupled by sockets in excavated trenches, on bridges and culverts, as per construction specification and sealing of PLB HDPE Ducts pipe ends at every joint/loop chamber by end-plugs of appropriate size.

7.4.2.3 Providing additional protection by GI/DWC/RCC pipes and/or concreting/ chambering, wherever required according to construction specification. Normally, DWC & GI pipes shall be used. In case it is felt that use of RCC pipe is unavoidable under certain circumstances this should be done with prior approval of engineer in charge. This shall be recorded properly.

7.4.2.4 Fixing of GI pipes/troughs with clamps on culverts/bridges and / or chambering or concreting of G.I. Pipes/troughs, wherever necessary. This should be done with the prior approval of competent authority. This shall be recorded appropriately.

7.4.2.5 **Laying Protection Pipes on Bridges and Culverts.** In case trenching and pipe laying is not possible on the culverts, the pipes shall be laid on the surface of the culverts/bridges after due permission from the competent authority **as per construction specification.**

7.4.2.6 Back filling and Dressing of the Trench according to construction specifications.

7.4.2.7 Deleted.

7.4.2.8 Digging of pit of size 1.2 m X 1.2 m X 1.2 m (deep) for fixing of jointing chambers pre-cast RCC cover/stone cover of suitable size on jointing chamber to protect the joint and backfilling of jointing chamber with excavated soil duly seined to ensure that pebbles/stones are removed.

7.4.2.9 Deleted .

7.4.3 **Specifications of Materials to be used**

7.4.3.1 **PLB HDPE duct: -**

PLB HDPE Duct 40/33mm with all accessories as RDSO Specification No. RDSO/SPN/TC/45/2013 Rev:02 w.e.f. 06.04.2013 with latest amendment.

7.4.3.2 **Optic Fiber Cable: -**

Optical Fiber Cable armoured 24F with all accessories as RDSO Specification No. IRS TC 55-2006 Rev:01 w.e.f. 01.05.2006 with latest amendment.

7.4.3.3 **OFC Joint Enclosure: -**

Optical Fiber splice [Joint Enclosure (24 F) and Joint Enclosure (48 F)] for loose tube complete with all accessories as per TEC Specification No GR/OJC-02/02 Sep 2003 with latest amendment for 24 and 48 fiber.

7.4.3.4 **OFC Joint Chamber: -** The Joint/Loop chamber shall be provided at every joint/loop location to keep the OF cable joint well protected and also to house extra length of cable which may be required in the event of faults at a later date. The Joint chamber shall be of pre-cast RCC type as per construction specification as per drawing no RAILTEL/WR/OT/DFC/011.

7.4.3.5 **Fiber Management System: -**

- A. 48 Port E2000/APC FDMS : FDMS 48 Port E2000/APC 19" rack mount FDM of dimension 2U (Height) x 485 mm (width) X 330 mm (depth) with patch panel for 48, E2000/APC type connectors of R&M/Huber & Schuner make and pigtailed should be of corning/Sterlite fiber of length 1.5 to 5 mtrs & 900 microns with all installation material. The adapters have to be fixed on separate removable patch plates for easy maintenance of adapters and pigtailed in the FDMS during O&M operation. The top cover of the FDMS should be equipped with telescopic sliders. The FDMS should be supplied with all above mentioned accessories.

- B. 24 Port E2000/APC FDMS : FDMS 24 Port E2000/APC 19" rack mount FDM of dimension 1U (Height) x 485 mm (width) X330 mm (depth) with patch panel for 24, E2000/APC type connectors of R&M/Huber & Schuner make and pigtails should be of corning/Sterlite fiber of length 1.5 to 5 mtrs & 900 microns with all installation material. The adapters have to be fixed on separate removable patch plates for easy maintenance of adapters and pigtails in the FDMS during O&M operation. The top cover of the FDMS should be equipped with telescopic sliders. The FDMS should be supplied with all above mentioned accessories.
- C. Other Technical Parameter of E2000/APC Pigtail and Connector of FDMS
- i) Operating Temperature: -60°C to +85°C.
 - ii) Insertion Loss:
 - a) Insertion Loss of complete pigtail including adapter when tested from each direction in all conditions of operations: ≤ 0.3 dB
 - b) Insertion Loss of Adaptors: ≤ 0.1 dB
 - iii) Return Loss for each connector of pigtail E2K/APC : ≥ 60 dB
 - iv) The length and type of pigtail : 1.5 to 5 Mtr & E2K/APC.
 - v) Connector Body: Engineering thermoplastic (Glass filled PBT: Polybutylen Terephthalate)
 - vi) Color of connector body: E2K-APC connector: Green
 - vii) Radius of curvature: E2K-APC : 5 to 12 mm
 - viii) Minimum bending radius of the pigtail:
 - a) Loaded : 50 mm
 - b) Unloaded : 30 mm
- 7.4.3.6 **Patch Cords:** - Deleted
- 7.4.3.7 **Automatic fusion splicing machine:** Deleted.
- 7.4.3.8 **Optical time domain reflectometer (OTDR):** Deleted.
- 7.4.3.9 **Electronic cable and fault locator:** Deleted.
- 7.4.3.10 **Air conditioner:** Deleted
- 7.4.3.11 **Material for Providing Additional Protection**
- a) **RCC Full Round Pipes**
 - b) **RCC Split Pipes**
 - c) **G.I. Pipes**
GI pipe as per IS 1239/1990/92 (latest) Grade 'B' with associated collars etc.
 - d) **DWC Pipes:**
DWC (Double Walled Corrugated) pipe with associated collars etc as per specn.no.IS 14930 (latest), anti-rodent and flame retardant 78/63 mm or as per site requirement.
 - e) **Concreting in trenches:**
The strength of RCC/CC is dependent on proper curing, therefore, it is imperative that water content of CC/RCC mix does not drain out into the surrounding soil. In order to ensure this, the RCC/CC work should be carried out by covering all the

sides by yellow PVC sheets of weight not less than 1 kg per 8 sqm to avoid seepage of water into the soil. Concreting should be of 300mm (wide)x 200mm (thick) cross-section.

7.4.3.12 **Rubber Bush**

To prevent entry of rodents into PLB HDPE DUCTS, the ends of PLB HDPE DUCTS are sealed at every chamber and joint using rodent resistant hard rubber bush (cap) after optical fiber cable is pulled. The rubber bush should be manufactured from hard rubber with groove sand holes to fit into 40 mm PLB HDPE DUCTS pipe, so that it should be able to prevent the entry of insects, rodents, mud, and rainwater into the PLB HDPE DUCTS pipe. It should conform to TEC GR with latest amendments.(see Figure-2)

7.4.3.13 **Route/Joint Marker**

The Route/Joint markers are co-located with each joint/loop chamber. In addition Route markers are also to be placed where route changes direction like road crossings etc. Either RCC/Pre-cast or Stone based route markers can be used. The detailed specification and design of the same shall be as per construction specification. As per RailTel/WR/OT/ DFC/012

CONSTRUCTION SPECIFICATIONS

7.5 EXCAVATION OF TRENCHES

7.5.1.1 Trenching Location and Alignment of the Trench

The cable should be laid as per the approved route planned. Generally this cable is laid near to the railway boundary (typically 1-2 mtr inside the railway boundary). The alignment of the trench will be decided by EIC.

Once the alignment is marked, no deviation from the alignment is permissible except with the approval of Engineer-in-charge. While marking the alignment only the centre line will be marked and the Contractor shall set out all other work to ensure that, the excavated trench is as straight as possible. The Contractor shall provide all necessary assistance and labour, at his own cost for marking the alignment. Contractor shall remove all bushes, under growth, stumps, rocks and other obstacles to facilitate marking the centre line without any extra charges. It is to be ensured that minimum amount of bushes and shrubs shall be removed to clear the way and the contractor shall give all, consideration to the preservation of the trees.

The line up of the trench must be such that PLB HDPE pipe(s) shall be laid in a straight line, both laterally as well as vertically except at locations where it has to necessarily take a bend because of change in the alignment or gradient of the trench, subject to the restrictions mentioned elsewhere.

7.5.1.2 Line-Up

The line-up of the trench must be such that PLB HDPE Ducts shall be laid in a straight line except at locations where it has to necessarily take a bend because of change in the alignment or gradient of the trench, subject to the restrictions mentioned elsewhere. Trenching at bend should be such that maximum bend should not be more than 45 degree.

7.5.2 Method of Excavation

In built up areas/station yards, the contractor shall resort to use of manual labour / HDD only to ensure no damage is caused to any underground or surface installations belonging to Railways/other public utility services and/or private parties.

However, along the block section and cross country there shall be no objection to the Contractor resorting to mechanical means of excavation, provided that no underground installations exist in the path of excavation, if any, are damaged.

There shall be no objection to resort to horizontal boring to bore a hole of required size and to push through DWC Pipe (120/103.5 mm OD/ID) through horizontal bore at road crossing or rail crossing or small hillocks etc.

All excavation operations shall include excavation and 'getting out'. 'Getting out' shall include throwing the excavated materials at a distance of at least one meter or half the depth of excavation, whichever is more, clear off the edge of excavation. In all other cases 'getting out' shall include depositing the excavated materials as specified.

In Rocky strata excavation shall be carried out by use of electro mechanical means like breakers/ jack hammers or by blasting wherever permissible with express permission from the competent authority. If blasting operations are prohibited or not practicable, excavation in hard rock shall be done by chiseling/ jack hammers.

Trenching shall as far as possible be kept ahead of the laying of pipes. Contractor shall exercise due care that the soil from trenching intended to be loose for back filling is not mixed with loose debris. While trenching, the Contractor should not cause damage to any underground installations belonging to other agencies and any damage caused should be made good at his own cost and expense.

Necessary barricades, night lamps, warning board and required watchman shall be provided by the contractor to prevent any accident. While carrying out the blasting operations, the contractor shall ensure adequate safety by cautioning the vehicular and other traffic. The contractor shall employ sufficient man-power for this with caution boards, flags, sign writings etc.

The contractor should provide sufficient width at the trench at all such places, where it is likely to cave in due to soil conditions without any extra payment. A minimum free clearance of 15 cms. should be maintained above or below any existing underground installation. No extra payment will be made towards this. In order to prevent damage to PLB HDPE DUCTS over a period of time, due to the growth of trees, roots, bushes, etc., the contractor shall cut them when encountered in the path of alignment of trench without any additional charges.

In large burrow pits, excavation may be required to be carried out for more than 120 cms in depth to keep gradient of bed less than 15 degrees with horizontal. If not possible as stated above, alignment of trench shall be changed to avoid burrow pit completely.

Wherever the EIC consider it necessary to adopt shoring , the contractor will be required to adopt shoring for which the contractor shall have the sufficient quantities of shoring materials on the hand as per RailTel Drawing No. RailTel /WR/OT/DFC/016.

7.5.3 **Depth and Size of the Trench**

The depth of the trench from top of the surface shall not be less than 1.2 mtrs unless otherwise relaxation is granted by competent authority under genuine circumstances.

In rocky terrain, 0.6 mtrs depth and in non-rocky soil, 1.2 mtrs depth (typically and min 100 cm) shall be achieved with protection as defined in para 7.6. Depth less than this shall be done only with the prior approval of the competent authority and consent of the Engineer in-charge. This shall be properly documented. In all cases, the slope of the trench shall be less than 15 degrees with the horizontal surface. The width of the trench shall normally be 45 cms at the top & 30 cms at the bottom..

When trenches are excavated in slopes, uneven ground, inclined portion, the lower edge shall be treated, as top surface of land and depth of trench will be measured accordingly. In certain locations, such as uneven ground, hilly areas and all other Places, due to any reason whatsoever it can be ordered to excavate beyond standard depth of 120 cms to keep the bed of the trench as smooth as possible. Near the culverts, both ends of the culverts shall be excavated more than 120 cms. to keep the gradient less than 15 degree with horizontal. For additional depth in excess of 120 cms., no additional payment shall be applicable.

If excavation is not possible to the minimum depth of 120 cms., as detailed above, full facts shall be brought to the notice of the Engineer in charge in writing giving details of location and reason for not being able to excavate that particular portion to the minimum depth.

Approval shall be granted by the competent authority in writing under genuine circumstances. The decision of the competent authority shall be final and binding on the contractor.

7.5.3.1 **Dewatering:** The Contractor shall be responsible for all necessary arrangements to remove or pump out water from trench. The Contractor should survey the soil conditions encountered in the section and make his own assessment about dewatering arrangement that may be necessary. No extra payment shall be admissible for this.

7.5.3.2 **Wetting:** Wherever the soil is hard due to dry weather conditions, if watering is to be done for wetting the soil to make it loose, the same shall be done by the contractor. No extra payment shall be admissible for this.

7.5.3.3 **Blasting:** For excavation in hard rock : NA

7.5.3.4 **Trenching Near Culverts/ Bridges:** The PLB HDPE Ducts shall be laid in the bed of culvert at the depth not less than 120 cms protected by DWC/RCC pipes as decided by Engineer- in charge. Both ends of culverts shall be excavated more than 120 cms in depth to keep the gradient of shall less than 15 degree with horizontal. The bed of trench should be as smooth as possible.

7.5.3.5 While carrying out the work on bridges and culverts, adequate arrangement for cautioning the traffic by way of caution boards during day time and danger lights at night shall be provided. In case of small bridges and culverts, where there is a likelihood of their subsequent expansion and remodeling, the cable should be laid with some curve on both sides of the culvert or the bridge to make some extra length available for readjustment of the cable at the time of reconstruction of culvert or the bridge.

7.6 Laying OF PLB HDPE Ducts

After the trench is excavated to the specified depth, the bottom of the trench has to be cleared of all stones or pieces of rock and leveled up properly. A layer of soft soil (in case the excavated material contains sharp pieces of rock/stones) of not less than 5 cms is required for leveling the trench to ensure that the cable when laid will follow a straight alignment. Adequate care shall be exercised while laying so that the OF cables are not put to undue tension/pressure after being laid as this may adversely affect the optical characteristics of cables with passage of time.

The contractor shall ensure that trenching and pipe laying activities are continuous, without leaving patches or portions incomplete in between. In case intermediate patches are left, measurement of the completed portions will be taken only after work in such left over patches are also completed in all respects.

Preparatory to aligning the pipe for jointing, each length of the PLB HDPE Ducts shall be thoroughly cleaned to remove all sand, dust or any other debris that may clog, disturb or damage the optical fiber cable when it is pulled at a later stage. The ends of each pipe and inside of each Socket shall be thoroughly cleaned of any dirt or other foreign materials.

At the end of each day work, the open ends of the pipes sections shall be tightly closed with end caps to prevent the entry of dirt/mud, water or any foreign matter into PLB HDPE Ducts until the work is resumed.

The lesser depths shall be done only with the prior instructions/approval of the Engineer-in-charge & suitable protection shall be provided to PLB HDPE pipes/coils as mention below.

NON ROCKY AREA

- a) **For depth at 1.2mtrs in non rocky area:** The trench should be made to the best possible depth up to 1.2 mtrs & min. width of 300 mm bed of trench should be leveled and clear from all size of pebbles. Afterwards properly coupled HDPE duct shall be laid and the overall depth shall be filled and consolidated by pebble free soil upto 250 mm. Then final back filling of soil shall be done. As per the Drawing specification No. RailTel/WR/OT/DFC/001.

ROCKY AREA : Deleted

7.6.1 **TRACK CROSSING:**

All cable crossings across railway tracks shall be done in DWC pipes of 120/103.5 mm OD/ID, threading the cable through these pipes. The contractor shall do the trenching to the required depth wherever necessary such as approaches to track crossing and the length in between the adjacent tracks. Two no. of Nylon ropes shall be threaded through DWC pipes as per EIC, one to pull the cable and one for future use. The arrangement of cable and DWC Pipes under Track crossings has been shown in Drg. No. RAILTEL/WR/OT/DFC/009.

7.6.2 ROAD CROSSING

- a. When crossing road ways, it is necessary to lay the cables in such a manner as to avoid the necessity of handling the cable sharply and minimize excavation of road surface as far as possible. Where cable is laid in surfaced trunking, the trunking alignment should be curved down to the pipes and proper brick or concrete joint should be made between trunking and pipe.
- b. The crossing of main roads often involves difficulties especially if traffic is heavy, precautions to avoid accidents to workmen, pedestrians and vehicles should be taken. On minor roads which can be temporarily closed to traffic it is possible to cross the entire width of the road and open up. Pipes should be installed quickly in the cutting which is then filled in there by reducing to a minimum time for which the road is closed.
- c. Some roadways which are broad may be opened for half their width, allowing the other half for use of traffic. Pipes are laid trench filled in the first half and the other half opened up after the first half is opened for the traffic. Pipes laid in the second half is linked with those laid in the first half. DWC pipes shall be used for road crossings. In all cases pipes should be laid at a depth of 1.2 meter, below the formation level or lower as may be required.
- d. Whenever a cable is laid across an important road particularly one with a special surface it is good investment to provide for future expansion. One cable per pipe should be laid. Two length of Nylon rope shall be used as lead wire. Two such lengths of Nylon rope shall be laid through the pipe. One wire shall be used for leading in the cable & the other wire shall be kept with suitable overlay to enable cable pulled out at later stage, if required.
- e. Drg. No. RAILTEL/WR/OT/DFC/010 given showing the arrangement of DWC pipe under metal roads.
- f. At busy road crossings, trenching should be done in nights with appropriate protection and road warnings to road users.

7.6.3 CABLE OVER STEEL GIRDER BRIDGES

- a) Where the cable has to cross girder bridges, the cable shall be protected in GI pipe as RAILTEL/WR/OT/DFC/006(a), RAILTEL/WR/OT/DFC/006(b), fitted on the girder bridges with suitable clamps without driving holes in the girders. GI pipe may also be required to be fitted on walk way/ bridge's substructure as per decision of Engineer. The drawings for installation arrangement shall be developed by contractor and got approved from RailTel.
- b) Nylon rope shall be pulled inside the pipe to enable pulling of duct/ cable. The GI pipe shall be jointed. Arrangements for opening the GI pipe through collars later at approx 50 M shall be provided.
- c) The GI pipe shall be extended by 4 – 6 meters beyond the bridge abutment and joined with brick channeling with RCC/ DWC pipe which shall be extended in the slope of formation, till the trench becomes horizontal at normal surface level. RCC/Brick pillars shall be made to prevent slipping of RCC/DWC pipe as approved by EIC.

- d) When laying cable on long bridges, the question of longitudinal expansion caused by temperature differences should be taken into consideration and suitable cable loops should be provided at the pillars of the bridge.
- e) The laying of the cable on the bridges is to be done with much care and planning. It is necessary that the cable drum to be laid on the bridge is inspected and tested thoroughly so that damaged cable is not installed.
- f) Wherever GI pipes are used, special care should be taken to ensure that G.I. Pipes are coupled properly with the sockets so as to avoid damage to PLB pipe and eventually the OF Cable in the event of pressure coming on the joint and GI Pipe joint giving its way. Rubber bushes shall be used at either ends of the GI pipes to protect PLB pipe. Both the ends of GI Pipe will be embedded in a concrete block of size 40 cms (L) x 40 cms ((W) x 25 cms (H) of 1:2:4 cement concrete mix (1:53 grade cement of reputed brand, 2: coarse sand, 3: stone aggregate of nominal size of 20 mm) so that the alignment of GI Pipes remain firm and intact and to avoid entry of rodents.

7.6.4 CULVERTS AND ARCH BRIDGES

- a) Wherever possible the cable shall be laid under the bed of the culvert through RCC pipes at the depth of 1.2 mtr or more to suit the site conditions. Both ends of the RCC pipes and joints shall be protected with brick masonry work (approx 300mmx300mmx300mm). The protection as above should be made from wing wall to wing wall of the culvert. As per Drawing No. RAILTEL/WR/OT/DFC/008.
- b) In case of wet culverts or unfriendly terrains where it is not possible to lay cable under the bed of culverts, the cables may be laid over the culvert in GI pipes as per *Drg. No.* RAILTEL/WR/OT/DFC/007
- c) On Arch Bridges also the cables/ducts shall be laid in GI pipes close to the retaining wall as per RAILTEL/WR/OT/DFC/013.
- d) In the approach of culverts & bridges the cables/ducts should be laid in brick channels or RCC pipes, as per As per Drawing RAILTEL/WR/OT/DFC/008.

7.6.5 CABLES IN CONGESTED RESIDENTIAL AREAS AND MARSHY AREAS:

In marshy area where it is not possible to divert the cable route the cable shall be suitably laid and protected as per decision of Engineer depending on site condition, like laying cable in DWC pipe supported on Masonry Pillars/Iron channels etc.

7.6.6 LEADING OF CABLE IN MASONRY BUILDINGS / SHELTERS.

- a) The cable will have to be led inside any masonry building such as Cable hut, ASM's room at a depth of 0.75 meters by cutting the masonry structure of the wall as per *Drg. No. as per Drawing No.* RAILTEL/WR/OT/DFC/014 After the cable has been led inside the masonry wall the floor inside shall be duly repaired and plastered.

7.6.7 LAYING OF CABLE THROUGH TUNNELS CUTTING:

In tunnels & cutting OFC cable shall be laid on GI pipe which should be fixed either along wall after clamping or on the foot of the tunnel with cement mortar of min 100mm thickness. The cable duct shall be laid through GI pipe.

7.6.7 LAYING OF CABLE IN SPECIAL CASES:

a) Near Power Cable

When the contractor comes across any other cable already laid, he shall first report the fact to the Engineer. Should the cable be identified by the Engineer as a power cable (LT or HT), the trench shall be dug as far away from the route of the power cable as practicable.

b) Crossing of Optical Fiber Cable with another cable

Crossing of the Optical Fiber cable with another cable shall be avoided wherever possible. Where, however, this is not possible, the Optical Fiber cable shall be laid in DWC. The length of the pipe to be provided on either side of the crossing shall be at least one meter.

c) ON 25 KV AC TRACTION AND GENERAL SCHEME OF OFC SYSTEM.

- i) Any Telecommunication circuits in the vicinity of AC Traction running Parallel to 25 KV lines are liable to be affected by AC induced voltage. Therefore precautions should be taken to eliminate the possibility of induced voltage affecting equipment and humans.
- ii) Crossing of track, if any, should be negotiated by underground cables running at right angles to the track as far as practicable.
- iii) Special protective measures (viz. provision of G.D tubes, fuses and earthing etc) are required to be taken for telecommunication lines entering 25 KV substation/ switching posts.
- iv) For the human safety considerations the safe working voltages should be 60 V under normal conditions and 150 V with special precautions and 430 V under fault conditions.
- v) Instructions for protection of RailTel staff/working personals on signaling and telecommunications installations on 25 kV AC traction shall be strictly adhered to.
Precautions are required to be taken on account of following,
 - a) Proximity of live conductor.
 - b) Pressure of return current in Rails.
 - c) Induction in all metallic bodies situated
 - d) Closed to over head equipment.

7.6.9 Laying of other than optical fiber cables in the same Trench

No cable other than quad shall be laid in the trench for the Optical Fiber cable. Even in such cases, both the cables are to be laid as per approved drawing. Where, however, exceptional circumstances exist, the optical fiber cable may be laid along with another cable in the same trench provided a specific permission of each such case is obtained in writing from Engineer. When optical fiber cable and L.T. power cable have to be laid in the same trench they shall be separated by placing a layer of brick between them vertically (approx.16 bricks/meter) or laid in DWC pipe.

7.6.10 Laying of cable through pipes

- i. The ducts shall be laid through DWC pipes at the locations marked on the route plan and as advised by the Engineer or his representative.
- ii. For laying the cable through pipes Nylon rope shall be used as a lead wire. Two such lengths of wires shall be laid through the pipes, so that after the cable is threaded through the pipe, one lead wire is permanently left in the pipe with a suitable overlay at two ends, to enable the cable to be pulled out at a later stage if required to do so.
- iii. On arch bridges and culvert bridges the cables will be threaded through G.I./DWC /RCC pipes etc. While threading the cable through these pipes the Contractor shall do the trenching to the required depth wherever necessary for which no extra charge will be paid.
- iv. DWC HDPE pipes shall not be used where directly exposed to sun. These shall invariably be underground and covered.

7.6.11 Laying cable near feeding post:

In the vicinity of feeding posts, as far as possible the cable shall be laid on the side of the track opposite to the feeding post. Further the Optical fiber cable shall be at least one meter away from any metallic part of the O.H.E. and other equipment at the substation which is fixed on the ground and at least one meter away from the substation earthing. In addition, the cable shall be laid in DWC / RCC pipe for a length of 300 meters on either side of the feeding point.

7.6.12 Running of cables at foundations others than OHE Masts and from pipe outlets.

Damages to cable is likely to occur if care is not taken in laying cable where the bed changes from solid support such as a foundation pipe or bridge to soft support such as soft soil. The cable must not press against the edge of the solid support. The soft soil near the edge must be tamped and the cable rose slightly.

7.6.13 Laying near oily surface

If during the excavation of trenches for laying cables, the Contractor or his representative notices the presence of oil or oily substance or any other chemical which is likely to cause the deterioration of the cable protective material he shall bring the matter to the notice of the Engineer or his representative and on the latter's decision he shall choose an alternative cable route or he shall protect the cable in such places in such manner as advised in writing by the Engineer or his representative. No additional charges are payable.

7.6.14 Special soil condition

Cable should not be run through abnormally high acidic or alkaline soil or through sewage. If this is unavoidable, special measures should be taken against corrosion as advised by the Engineer in Charge.

7.6.15 Provision of damage due to sharp edges

When cable are laid in trunking, care should be taken to see that no ballast or stones have been dropped inside the trunking and it should be cleared of all ballast and stones before the cover is secured. When the ends of covers are joined together with cement plaster, a piece of paper or wood should be placed under the joint to prevent the cement plaster from falling on the cables.

7.7 Back filling and dressing of the trench

Provided that the PLB HDPE pipes have been properly laid in the trench at the specified depth, the back filling operation shall follow as early as practicable. The earth used for filling shall be free from all roots, Grass, shrubs, vegetation, trees, saplings and any other kind of garbage or pebbles. The back filling operation shall be performed in such a manner so as to provide firm support under and above the pipes and to avoid bend or deformation of the PLB HDPE pipes when the pipes get loaded with the back filled earth.

At locations where the back filled materials contains stones/sharp objects which may cause injury to the PLB HDPE pipes and where the excavated or rock fragments are intended to refill the trench in whole or in part, the trench should be initially filled, with a layer of ordinary soil or loose earth (free from any stones/pebbles) not less than 10 cms thick over the pipes.

Back filling on public, roads, railway crossings, footpaths in city areas shall be performed immediately after laying the HDPE pipes. Back filling at such locations shall be thoroughly rammed, so as to ensure original condition so that it is safe for the road traffic. All excess soil/ material left on road/ footpath/railway crossing shall be removed by contractor. However, along the highways and in country side, the excess dug up material left over after refilling should be kept in a heap above over the trench.

In city limits, at any given time not more than 50 Meters length of trench should be kept open and in all places where excavation has been done, no part of the trench should be kept open over night to avoid occurrence of any mishap or accident in darkness.

In normal Railway area the trenching should be done for one drum length (approx 3Km) and back filled within 2 days after laying of duct , the work schedule be inspected by RailTel EIC before backfilling/ laying of HDPE duct.

7.8 Blowing of Cable:

Optical Fiber Cable will be blown into one of pre – lubricated HDPE duct laid in DWC pipe with the help of a compressor and blowing equipment. (With minimum pressure of 8 bar and maximum pressure of 12 bar with flow rate of minimum 10 m³ / minute)

The blowing method involves feeding of optical fiber cable into the duct with the help of consistent high – pressure airflow, equally distributed along the entire cable throughout the duct.

The contractor has to ensure the safe blowing of OFC into the duct without any damages to the cable either internally or externally.

If at any stage of the project, any damage to the cable due to blowing pressure is identified, than the contractor will be fully responsible for that and has to ensure the rectification of the damage without any cost implication to the owner.

Optical Fiber Cable drum are available in the drum length of about 3 km.

Contractor may follow following steps for safe blowing of OFC

Position the compressor and blowing machine at blowing pit C for location A & E shown below

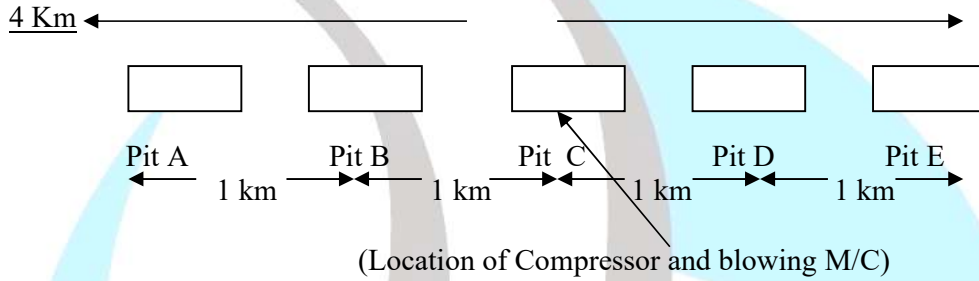

Put the cable drum on cable wheel and blow the OFC towards pit A. Put the pusher equipment if required at B.

When the cable reaches pit A and coil of 10 – 15 m of OFC should be kept in pit A. Then seal the duct end at A with the sealing plug.

Uncoil the cable on the drum in a figure of eight configuration and blow towards blowing pit E and coil of 10 – 15 m of OFC should be kept in pit E. Then seal the duct end at E with the sealing plug.

Since the cable will be available in length of 3 km and above, so the contractor has to plan the location of blowing pits before laying of HDPE duct. The contractor has to ensure that excess OFC is not coiled in the blowing pit and also optical fibre cable does not fall short of the location of blowing pit. The contractor has to match the cable drum length with the location of blowing pits, to ensure minimum cut length and wastage of OFC. To achieve the blowing of above shown stretch, blowing can be carried out downhill, wherever possible.

HDPE ducts will be sealed with the help of cable sealing plugs after blowing of OFC into the duct at jointing pit locations.

The jointing pits will be completely filled with sand up to 30 cm, from bottom level of the pit to prevent entry of rodents after blowing and jointing of OFC covering joint enclosure and HDPE conduits completely.

7.9 Pre cast RCC chamber

Pre cast RCC chamber of dimension 1m x1mx0.6 m (depth), & each wall of chamber must be min 25 mm thick & made of cement mortar mixture in 1:6 ratio. For fixing of chamber first a pit of size 1.2 m x1.2 m x 1.2 m (depth) shall required to be dug. Pre cast RCC chamber shall be installed in excavated pit. The RCC slab of dimension 1.2m x1.2mx 0.05m (thickness) is used as cover of chamber with 2 nums of handle /slots for lifting of cover and word ‘ ‘RCIL CHAMBER’ ’ engraved on it. After, fixing the pre cast RCC joint chamber, the joint chamber is filled with clean sand upto 30 cms before closing. Back filling of joint chamber pit with excavated soil shall be carried out in the end. Details are mention in drawing No. RailTel/WR/OT/DFC/011.

7.10 Fixing of Route Indicators/Joint Indicators.

The cable markers shall normally be provided at the distance of every 50 meters in front of the every OHE Gantry Post and also at places or corners wherever the route of the cable changes. The joint markers shall be provided at all types of cable joints/loop chambers and painted with green colour and rest of marker shall be painted with yellow colour. The cable Marker and joint markers provided shall be of standard stone RCC type with letters "RCIL OFC" engraved and suitably painted with standard trend as per site conditions. In rocky area concreting shall be done. As per the drawings mention at as per DRG NO.RAILTEL/WR/OT/DFC/012.

7.11 Documentation

The documentation, consisting of the following shall be prepared for entire route .4 sets of documentation shall be provided both in Electronic format on CD as well as Hard binded copies.

7.11.1 **Route Index Diagrams** – General: This diagram shall consist of Cable Route Details on Geographical Map drawn to scale with prominent land marks and alignment of cable with reference to railway track. This shall be prepared on A-3 sheets.

7.11.2 Route Index Diagrams –Profile

These diagrams will contain

- Make and size of the cable.
- Offset of cable from centre of the railway track at every 10 meters
- Depth profile of Cable at every 10 meter;
- Details of protection with type of protection depicted on it;
- Location of culvert and bridges with their lengths and scheme of laying of PLB HDPE Ducts pipe thereon.
- Important landmarks to facilitated locating the cable in future; Location of Joints and pulling manholes.
- The contour of railway track and Railway boundary.
- Geographical location of all the joints.
- Depth of Joint Chamber covers from ground level
- Route markers.
- Length of O.F. Cable kept inside the joint chamber from either direction.

All the diagrams shall bear the signatures of the contractor, the Engineer-in-charge as a proof of accuracy of the details. The diagrams shall be bound in A-3 size book with cover.

The cover sheets shall be laminated. The front cover shall have the following details.

1. Name of the section.
2. RailTel coloured Logo.
3. Name of the Contractor
4. Date of commencement of work
5. Date of completion of work.

7.12 SAFETY PRECAUTIONS

7.12.1 Safety Precautions when excavating or working in excavations close to electric cables

The Engineer- in-charge of the work should get full information from Electricity undertaking regarding any electric cables, which are known or suspected to exist near the proposed excavation and unless this is done, excavation should not be carried out in the section concerned. The electricity undertaking should be asked to send a representative and work should be preceded with close consultation with them.

Only wooden handled hand tools should be used until the electric cables have been completely exposed. Power Cables, not laid in conduits, are usually protected from above by a cover slab of concrete, brick or stone. They may or may not be protected on the sides. It is safer, therefore, always to drive the point of the pickaxe downwards then uncovering a cable, so that there is less chance of missing such warning slabs. No workman should be permitted to work alone where there are electric cables involved. At least one more man should be working nearby so that help can be given quickly in case of an accident. If disconnection of power could be arranged in that section it will be better. No electric cables shall be moved or altered without the consent of the Electric Authority and they should be contacted to do the needful. If an electric cable is damaged even slightly, it should be reported to the Electric Authority and any warning bricks disturbed during excavation should be replaced while back filling the trench. Before driving a spike into the ground, the presence of other underground properties should be checked. Information on plans regarding the location of power cables need not to be assumed as wholly accurate. Full precautions should be taken in the vicinity until the power cable is uncovered. All electric cables should be regarded as being live and consequently dangerous. Any power is generally dangerous, even low voltage proving fatal in several cases.

7.12.2 Electric shock-Action and treatment :

Free the victim from the contact as quickly as possible. He should be jerked away from the live conductors by dry timber, dry rope or dry clothing. Care should be taken not to touch with bare hands as his body may be energized while in contact. Artificial respiration should begin immediately to restore breathing even if life appears to be extinct. Every moment of delay is serious, so, in the meanwhile, a doctor should be called for.

7.12.3 Safety Precautions while working in public street and along railway lines :

Where a road or footpath is to be opened up in the course of work, special care should be taken to see that proper protection is provided to prevent any accidents from occurring. Excavation work should be done in such a manner that it will not unduly cause inconvenience to pedestrians or occupants of buildings or obstruct road traffic. Suitable bridges over open trenches should be so planned that these are required for the minimum possible time. Where bridges are constructed to accommodate vehicular traffic and is done near or on railway property, it should be with the full consent and knowledge of the competent railway authorities.

- 7.12.4 **Danger from falling material**
Care should be taken to see that apparatus, tools or other excavating implements or excavated materials are not left in a dangerous or insecure position so as to fall or be knocked into the trench thereby injuring any workman who may be working inside the trench.
- 7.12.5 **Care when working in Excavations**
Jumping into a trench is dangerous. If it is deep, workmen should be encouraged to lower themselves. Workers should work at safe distance so as to avoid striking each other accidentally with tools. If the walls of the trench contain glass bits, corroded wire or sharp objects they should be removed carefully. If an obstruction is encountered, it should be carefully uncovered and protected if necessary. If an obstruction is encountered, it should be carefully uncovered and protected if necessary. Care must be taken to see that excavated material is not left in such a position that it is likely to cause any accident or obstruction to a roadway or waterway. If possible the excavated material should be put between the workmen and the traffic without encroaching too much on the road.
- 7.12.6 **Danger of cave in**
When working in deep trenches in loose soil, timbering up/shoring the sides will prevent soil subsidence. The excavated material should be kept at sufficient distance from the edge of the trench or pit. Vehicles or heavy equipment must not be permitted to approach too close to the excavation.

When making tunneled opening, it should be ensured that the soil is compact enough to prevent cave in even under adverse conditions of traffic. Extra care should be taken while excavating near the foundations of buildings or retaining walls. In such cases, excavation should be done gradually and as far as possible in the presence of the owners of the property.
- 7.12.7 **Protection of Excavations :**
Excavations in populated areas, which are not likely to be filled up on the same day should be protected by barriers or other effective means of preventing accidents and the location of all such openings must in any event be indicated by red flags or other suitable warning signs. During the hours from dusk to dawn, adequate number of red warning lamps should be displayed. Supervisory officers should ensure that all excavations are adequately protected in this manner as serious risk and responsibility is involved. Notwithstanding adoption of the above mentioned precautions, works involving excavations should be so arranged as to keep the extent of opened ground and the time to open it to a minimum.
- 7.12.8 **Precautions while working on roads**
The period between half an hour after sun-set and half an hour before sunrise, and any period of fog or abnormal darkness may also be considered as night for the purpose of these instructions, for the purpose of providing the warning signs. Excavation liable to cause danger to vehicles or the public must at all times be protected with fencing of rope tied to strong uprights or bamboo poles at a suitable height or by some other effective means. Any such temporary erection which is likely to cause obstructions and which is not readily visible should be marked by posts carrying red flags or boards with a red background by day and by continuously lighted lamps at night.

The flags and the lamps should be placed in conspicuous positions so as to indicate the pedestrians and drivers of vehicles the full expanse i.e. both width and length of the obstruction. The distance between lamps or between flags should not generally exceed 1.25 m along the width and 6m along length of the obstruction in non congested areas, but 4 meters along the length in congested areas.

If the excavation is extensive, sufficient notice to give adequate warning of the danger, should be displayed conspicuously not less than 1.25 m above the ground and close to the excavation. Where any excavation is not clearly visible for a distance of 25m to traffic approaching from any direction or any part of the carriage way of the road in which the excavation exists, a warning notice should be placed on the kerb or edge of all such roads from which the excavation or as near the distance as is practicable but not less than 10 m from the junction of an entering or intersecting road in which the excavation exists. All warnings, in these should have a red background and should be clearly visible and legible. All warning lamps should exhibit a red light, but white lights may be used in addition to facilitate working at night. Wherever required a passage for pedestrians with foot bridge should be provided. At excavations, cable drums, tools and all materials likely to offer obstructions should be properly folded round and protected. This applies to jointer's tents as well. Leads, hoses etc. stretched and across the carriageway should be guarded adequately for their own protection and also that of the public.

7.12.9 **Traffic Control**
Deleted.

7.12.10 **Work along Railway Lines Deleted**

7.12.11 **Procedure and Safety Precautions for use of explosives during blasting for trenching :**

In areas where the cable trench cannot be done manually on account of boulders and rocks, it is necessary to blast the rocks by using suitable explosives. The quality of explosive to be used depends on the nature of the rocks and the kind of boulders. A few types of explosive fuses and detonators normally used for making trenches for cable works are detailed below:

- i) Gun powder
- ii) Nitrate Mixture
- iii) Gilatine
- iv) Safety fuse
- v) Electric Detonator
- vi) Ordinary Detonator

7.12.11.1 **Procedure**

In case blasting is to be carried out, the same shall be done with due permission and co-ordination with Railways after ensuring all safety precautions. A detailed survey of the route is to be done to assess the length of the section where trenching is to be done with the help of blasting. A route diagram of the rocky section may be prepared indicating the length of the route where the explosives are to be used. For the purpose of obtaining license, a longer length of route should be given in the application as in many cases, after digging, rocks appear which was not initially anticipated.

Next a license will have to be obtained for use and storing of explosive in that section. If the area falls under a police commissioner, the authority for granting such license is the police commissioner of the concerned area. When the route does not fall in the jurisdiction of a police commissioner, the authority for issuing license is the District Magistrate.

The concerned authority should be applied in prescribed form with a route map. The concerned authority will make an enquiry and issue license for using/storing explosives for cables trenching work. Such license will be valid for 15 days only. The license should be got renewed if the blasting operation needs to be extended. Once the license is granted, it is the responsibility of the holders of the license for the proper use of explosives, its transportation and storing.

7.12.11.2 **Method of using**

The safest explosive is the Gilatine and electric detonator. Gilatine is in the form of a stick. Electric detonator is a type of fuse used for firing the explosive electrically. Holes are made at suitable intervals on rocky terrain or boulders either by air compressor or by manual chipping. The depth of the holes should be 2 to 3 ft. Fill up the holes with small quantity of sand for about 6". First the electric detonator is to be inserted into the Gilatine and the Gilatine is to be inserted into the holes keeping the + ve and - ve wirings of electric detonators outside the holes. Again refill the holes with sand. These +ve and -ve insulated wires of detonator are then extended and finally connected to an EXPLODER kept at a distance of not less than 100 m.

Now the explosive is ready for blasting. But, before connecting wires to exploder for blasting, all necessary precautions for stopping the traffic, use of red flags, exchange of caution signals, etc. should be completed and only then Exploder should be connected and operated.

7.12.11.3 **Operation of exploder (IDL schaffler type 350 type exploder)**

The type 350 blasting machine consists of a bearing block with blasting machine system and the explosion proof light- alloy injection molded housing. The exploder is held with the left hand. The twist handle is applied to the drive pin, clapped with the right hand turned in the clock wise direction in continuous measurements at the highest speed from the initial position until it reached to a stop. At this stage an indication lamp will glow. When the indication lamp glows, "press button switch" should be pressed. This will extend the electric current to detonator and Gilatine will be detonated. The rock will be blasted out of the trench. Number of holes can be blasted in a single stroke by connecting all such detonators in series connection and finally to the exploder.

After blasting, again mazdoors are engaged on the work to clear the debris. If the result of the first blasting is not satisfactory, it should be repeated again on the same place.

7.12.11.4 **Warning**

There may be two reasons for unsatisfactory results of the blasting

- a) Misfire of Gilatine due to leakage of current from detonator.
- b) Over loading because of overburdens.

Never pull the broken wire pieces from the holes in such cases. Attempt should not be made to reblast the misfired Gilatine. The safest way is to make a fresh hole by its side and put fresh Gilatine in that hole and blast it.

7.12.11.5

Precautions

The abstract of Explosives Rules 1983 which are relevant to our work is given below:

i. Restriction of delivery and dispatch of explosives

No person shall deliver or dispatch any explosives to anyone other than a person who.

a) is the holder of a license to possess the explosives or the agent of a holder of such a license duly authorized by him in writing on his behalf.

OR

b) is entitled under these rules to possess the explosives without a license.

The explosives so delivered or dispatched shall in no case exceed the quantity, which the person to whom they are delivered or dispatched is authorized to possess with or without a license under these rules.

No person shall receive explosives from any person other than the holder of a license granted under these rules. No person shall receive from or transfer explosives to any person for a temporary storage or safe custody in a licensed premise unless prior approval is obtained from the Chief Controller.

A person holding license for possession of explosives granted under these rules shall store the explosives only in premises specified in the license.

ii. Protection from Lightning During Storing

Every magazine shall have attached there to one or more efficient lightning conductors designed and erected in accordance with the specification laid down in Indian Standard Specifications No.2309 as amended from time to time. The connections to various parts of earth resistance of the lightning conductor terminal on the building to the earth shall be tested at least once in every year by a qualified electrical engineer or any other competent person holding a certificate of competency in this behalf from the State Electricity Department. A certificate showing the results of such tests and the date of the last test shall be hung up in conspicuous place in the building.

iii. Precautions during thunder-storm

When a thunder- storm appears to be imminent in the vicinity of a magazine or store house every person engaged in or a round such magazine and store house shall be withdrawn to a safe distance from such magazine or store house and the magazine and store house shall be kept closed and locked until the thunder storm has ceased or the threat of it has passed.

iv. Maintenance of records

Every person holding a license granted under these rules for possession, sale or use of explosives shall maintain records in the prescribed form and shall produce such record on demand to an Inspection Officer

- v. **Explosives not to be kept in damaged boxes**
The licensee of every magazine or store house shall ensure that, the explosives are always kept in their original outer package. In case, the outer package gets damaged so that the explosive contained therein cannot be stored or transported, such explosives shall be repacked only after the same are examined by controller of explosives.
- vi. **Storage of explosives in excess of the licensed quantity**
The quantity of any kind of explosives kept in any licensed magazine or store house shall not exceed the quantity entered in the license against such kind of explosives. No explosives in excess of the licensed quantity shall be stored in the magazine or store house unless a permit in this behalf is obtained from the licensing authority by a letter or telegram.
- vii. **Precautions to be observed at Site**
The electric power at the blasting site shall be discontinued as far as practicable before charging the explosives. No work other than that associated with the charging operations shall be carried out within 10 meters of the holes unless otherwise specified to the contrary by the licensing authority.

When charging is completed, any surplus explosive detonators and fuses shall be removed from the vicinity of the hole and stored at a distance which should prevent accidental detonation in the event of a charge detonating prematurely in any hole. The holes which have been charged with explosive shall not be left unattended till the blasting is completed. Care shall be taken to ensure that fuse or wires connected to the detonation are not damaged during the placing of stemming materials and tamping.
- viii. **Suitable warning procedure to be maintained**
The licensee or a person appointed by the licensee to be in charge of the use of explosives at the site shall lay down a clear warning procedure consisting of warning signs and suitable signals and all persons employed in the area shall be made fully conversant with such signs and signals.
- ix. **Precautions to be observed while firing**
The end of the safety fuse (if used in place of a detonator should be freshly cut before being lighted. The exploders shall be regularly tested and maintained in a fit condition for use in firing. An exploder shall not be used for firing a circuit above its rated capacity. The electric circuits shall be tested for continuity before firing. All persons other than the shot-firer and his assistant, if any, shall be withdrawn from the site before testing the continuity.

For the purpose of jointing, the ends of all wires and cables should have the insulation removed for a maximum length of 5 cms. and should, then be made clear and bright for a minimum length of 2.5 cms. and the ends to be joined should be twisted together so as to have a positive metal contact.

Then these should be taped with insulation to avoid leakage when in contact with earth. In case of blasting with dynamite or any other high explosive, the position of all the bore holes to be drilled shall be marked in circles with white paint. These shall be inspected by the Contractor's agent. Bore holes shall be of a size that the cartridge can easily pass down. After the drilling operation, the agent shall inspect the holes to ensure that drilling has been done only at the marked locations and no extra hole has been drilled. The agent shall then prepare the necessary charge separately for each bore hole. The bore holes shall be thoroughly cleaned before a cartridge is inserted. Only cylindrical wooden tamping rods shall be used for tamping. Metal rods or rod shaving pointed end shall never be used for tamping. One cartridge shall be placed in the bore hole and gently pressed but not rammed down. Other cartridges shall then be added as may be required to make up the necessary charge for the bore hole. The top most cartridge shall be connected to the detonator which shall in turn be connected to the safety fuses of required length. All fuses shall be cut to the length required before being inserted into the holes. Joints in fuses shall be avoided.

Where joints are unavoidable, a semi-circular niche shall be cut in one piece inserted into the niche. The two pieces shall then be wrapped together with string. All joints exposed to dampness shall be wrapped with rubber tape.

The maximum of eight bore holes shall be loaded and fired at one occasion. The charges shall be fired successively and not simultaneously. Immediately before firing, warning shall be given and the agent shall see that all persons have retired to a place of safety. The fuses of the charged holes shall be ignited in the presence of the agent, who shall see that all the fuses are properly ignited.

Careful count shall be kept by the agent and other of each blast as it explodes. In case all the charged bore holes have exploded, the agent shall inspect the site soon after the blast but in case of misfire the agent shall inspect the site after half an hour and mark red crosses (X) over the holes which have not exploded. During this interval of half an hour, nobody shall approach the misfired holes. No driller shall work near such bore until either of the following operations has been done by the agent for the misfired boreholes.

- i. The contractor's agent shall very carefully (when the tamping is a damp clay) extract the tamping with a wooden scraper and withdraw the primer and detonator.
- ii. The holes shall be cleaned for 30 cm of tamping and its direction ascertained by placing a stick in the hole. Another hole shall then be drilled 15 cm away and parallel to it. This hole shall be charged and fired. The misfired holes shall also explode along with the new one.

Before leaving the site of work, the agent of one shift shall inform the another agent relieving him for the next shift, of any case of misfire and each such location shall be jointly inspected and the action to be taken in the matter shall be explained to the relieving agent.

The Engineer-in-charge shall also be informed by the agent of all cases of misfire, their cause and steps taken in that connection.

x. General Precautions

For the safety of persons red flags shall be prominently displayed around the area where blasting operations are to be carried out. All the workers at site, except those who actually ignite the fuse, shall withdraw to a safe distance of at least 200 meters from the blasting site. Audio warning by blowing whistle shall be given before igniting the fuse.

Blasting work shall be done under careful supervision and trained personnel shall be employed. Blasting shall not be done within 200 meters of an existing structure, unless specifically permitted by the Engineer-in-Charge in writing.

xi. Precautions against misfire

The safety fuse shall be cut in an oblique direction with a knife. All saw dust shall be cleared from inside of the detonator. This can be done by blowing down the detonator and tapping the open end. No tools shall be inserted into the detonator for this purpose. If there is water present or if the borehole is damp, the junction of the fuse and detonator shall be made water tight by means of tough grease or any other suitable material. The detonator shall be inserted into the cartridge so that about one-third of the copper tube is left exposed outside the explosive. The safety fuse just above the detonator shall be securely tied in position in the cartridge. Water proof fuse only shall be used in the damp borehole or when water is present in the borehole. If a misfire has been found to be due to defective fuse, detonator or dynamite, the entire consignment from which the fuse, detonator or dynamite was taken shall be got inspected by the Engineer-in-Charge or his authorized representative before resuming the blasting or returning the consignment.

xii. Precaution against stray currents :

Where electrically operated equipments is used in locations having conductive ground or continuous metal objects, tests shall be made for stray current to ensure that electrical firing can proceed safely.

7.13

7.13.1

ALLIED ACTIVITIES

Transportation of Materials: The materials required for executing the work entrusted to the contractors against a work order shall be made available at Project Store Depot. In some cases the materials may be available at sub divisional store godawn. The contractor shall be responsible for transporting the materials, to be supplied by the RailTel or otherwise to execute the work under the contract to site at his/ their own cost. The costs of transportation are subsumed in the standard Schedule Rates and therefore no separate charges are payable on this account.

7.13.2 **Disposal of Empty Cable Drums :** The contractor shall be responsible to dispose of the empty cable drums after laying of the cables.

7.13.3 It shall be obligatory on part of the contractor to dispose of the empty cable drums at his/their level and the amount fixed for various empty cable drums shall be recovered from the bill for the work for which the drum (s) was/were issued or from any other amount due to the contractor or the Security Deposit.

7.13.4 The contractor shall not be allowed to dump the empty cable drums in Govt./ Public place which may cause inconvenience to the RailTel / public.

7.13.5 **Supply Of Materials:** There are some materials required to be supplied by the contractor for execution of work under this contract like Bricks, Cement, Wire Mesh and Steel for protection, etc., besides using other consumables which do/don't become the part of the asset. The contractor shall ensure that the materials supplied are of best quality and workmanship and shall be strictly in accordance with the specifications.

7.13.6 **Social auditing:** deleted.

7.14 **TECHNIQUE FOR JOINTING OF OPTICAL FIBRE CABLE**
Fusion splicing shall be used for splicing fibers. This is accomplished by applying localized heating (i.e. by electric arc or flame) at the interface between two butted, pre-aligned fiber ends, causing them to soften and fuse together.

7.14.1 **STRAIGHT JOINT FOR FIBRE OPTIC CABLE**
There are various types of joint enclosures available in the market. The procedure for assembly of joint closure is described in the installation manual supplied with straight joint closure. This includes the following:

- a) Material inside joint closure kit
- b) Installation tools required
- c) Detailed procedure for cable jointing
- d) Procedure for re-opening the closure.

The Optic Fiber straight through joint closure shall be as per specn. TEC TO 910 G92 (latest) or a proven design approved by RCIL. The joint shall be protected in prefabricated RCC joint pits. If the contractor intends to supply joint enclosure which is not as per TEC specification, before starting the supply, contractor shall submit-

- i) The specification of joint enclosure
- ii) Users certificate regarding its satisfactory performance

At the discretion of the RCIL, contractor will have to demonstrate the working of the joint enclosure. Based on specification, user certificate and demonstration. RCIL, if RCIL finds the design suitable, will grant specific approval to use the joint enclosure. The supply of joint enclosure, which is not of TEC design, shall start only after the approval is received from RCIL

However, generally, the following steps are involved for jointing of the cable:

- Preparation of cable for jointing
- Stripping/cutting the cable
- Preparation of Cable and joint closure for splicing
- Stripping and Cleaving of Fibers
- Fiber splicing
- Organizing fibers and Finishing joints
- Sealing of joint closure and
- Placing joint in pit.

7.14.2

PREPARATION OF CABLE FOR JOINTING

- a) During the installation, a minimum of 10 meter of cable of each end is coiled in the jointing pit to provide for jointing to be carried out at convenient location as well as spare length to be available for future use in case of failures.
- b) The pit size must be chosen carefully to ensure that length of the wall on which joint is mounted is greater than closure length plus twice the minimum bending radius of the cable. A pit length of 1 meter is sufficient for most of the cable and joint closures. Bracket to support the cable coil are also fixed on the wall of the pit.
- c) The cable is then coiled on to the pit wall in the same position as required after the joint is complete. The marking is done on all the loops so that it will be easier to install it later.
- d) The distance from the last center to the end of the cable must be at least 1.8 meter. This is being the minimum to be stripped for Preparation of joint.
- e) Sufficient cable at each end up to the jointing vehicle/enclosure is then uncoiled from the pit for jointing.

7.14.3

STRIPPING/CUTTING OF THE CABLE

- a) The cables are stripped of their outer and inner sheath with each sheath staggered approximately 10mm from the one above it.
- b) Proper care must be taken when removing the inner sheath to ensure the fibres are not scratched or cut with the stripping knife or tool. To prevent this, it is best to only score the inner sheath twice on opposite sides of the cable, rather than cut completely through it. The two scores marking on either side of the cable are then stripped of the inner sheath by hand quite easily.
- c) The fibers are then removed from cable one by one and each fiber is cleaned individually using Kerosene to remove the jelly.

7.14.4

PREPARATION OF CABLE JOINT CLOSURE FOR SPLICING

The type of Preparation work performed on the cable prior to splicing differs on the type of joint closure and fiber organizer used. However, the following steps are usually common: -

- a) The strength members of each cable are joined to each other and/or to the central frame of the joint closure.
- b) The joint closure is assembled around the cable.
- c) The sealing compound or heat shrink sleeve is applied to the cables and closure, or prepared for application after splicing is complete
- d) The fibers are protected (usually with plastic tubing) in their run from the cable core to the fiber organizer trays (particularly if cable construction is slotted core type).
- e) Tags, which identify the fibers no. are attached at suitable location on the fibers.
- f) Splice protectors are slipped over each fiber in readiness for placing over the bare fiber after splicing.

7.14.5 **STRIPPING AND CLEAVING OF FIBRE**

- a) Prior to splicing each fiber must have approximately 50mm of its primary protective U.V. cured coating removed, using fiber stripper which are manufactured to fine tolerances and only score the coating without contacting the glass fiber.
- b) The bare fiber is then wiped with a lint free tissue doused with ethyl alcohol.
- c) Cleaving of the fiber is then performed to obtain as close as possible to a perfect 90 degree face on the fiber.

7.14.6 **SPLICING OF THE FIBRES**

The fusion splicing shall be used for fiber splicing. Some of the basic steps for fusion splicing are as given in 7.14.7

7.14.7 **FUSION SPLICING OF FIBRE**

Some of the general steps with full automatic microprocessor control splicing machine are as under:

- a) Wash hands thoroughly prior to commencing this procedure.
- b) Dip the clean bare fiber in the beaker of ethyl alcohol of the ultrasonic cleaver. Switch on ultrasonic cleaver for 5-10 seconds (Some of the manufacturers do not prescribe the above cleaning).
- c) Place the bare fiber inside 'V' groove of the splicing machine by opening clamp handle such that the end of fiber is app. 1 mm. over the end of the "V" groove towards the electrodes.
- d) Repeat the same procedure for other fiber, however, first insert heat shrink splice protector.
- e) Press the start button on the splice controller.

- f) The machine will pre fuse, set align both in 'X' and 'Y' direction and than finally fuse the fiber.
- g) Inspect the splice on monitor if provided on the fusion splicing machine and assure no nicking, bulging is there and cores appear to be adequately aligned. If the splice does not visually look good repeat the above procedure.
- h) Slide the heat shrink protector over the splice and place in tube heater. Heat is complete when soft inner layer is seen to be 'oozing' out of the ends of the outer layer of the protector.
- i) Repeat for other fibers.

7.14.8 **FUSION SPLICER AND OTDR**

The fusion splicer and Optical Time Domain Reflectometer (OTDR), to be used for splicing and measurements of Parameters respectively, shall be of approved design and quality. The contractor shall submit

- i) Specification of fusion splicer and OTDR.
- ii) Certificate from the users, who have used the splicer and OTDR of the make, the contractor intends to use, regarding their satisfactory performance.

The RCIL reserves the right to direct the contractor to use the same or any other proven design of fusion splicer and OTDR if in the opinion of RCIL the specification of Fusion splicer and OTDR are not suitable.

7.14.9 **ORGANIZING FIBRE AND FINISHING JOINTS**

- a) After each fiber is spliced, the heat shrink protection sleeve must be slipped over the bare fiber before any handling of fiber takes place, as uncoated fibers are very brittle and cannot withstand small radius bends without breaking.
- b) The fiber is then organized into its tray by coiling the fibres on each side of the protection sleeve using the full tray side to ensure the maximum radius possible for fiber coils.
- c) The tray is placed in the position.
- d) OTDR reading taken for all splices in this organized state and recorded on the test sheet to confirm that all fibers attenuation are within specification. This OTDR test confirms fibers were not subjected to excessive stress during the organizing process.
- e) After this the joint can be closed with necessary sealing etc. and ready for placement in the pit.

7.14.10 **PLACING OF COMPLETED JOINT IN PIT**

- a) Joint is to be placed on the tarpaulin provided near the pit.

- b) The cable is laid on the ground, loop the cable such that pen mark previously place on the cable line up. Tape these loops together at the top of the coil.
- c) The joint can now be permanently closed and sealed by heating heat shrinkable sleeve etc. However, before closing, silica gel to be kept inside for moisture protection.
- d) Now the joint closure is fixed to the bracket on the pit wall and pit is closed.

7.14.11 **RE-OPENING OF THE JOINT**

If required for attending to faults etc., manufacturers supply special kits for opening of the joint and the steps to be followed. However, the general steps are as under: -

- a) Using suitable knife cut heat shrink sleeve longitudinally along its entire length.
- b) Do not damage the smaller heat shrunk sleeve on the ends of the joint.
- c) Apply heat to the cut sleeve until it begins to separate.
- d) Gently remove the cut sleeve from the joint. Now the joint can be opened.
- e) Protective sleeve/cover can be removed for attending to faults etc.

7.14.12 **TERMINATION JOINT FOR FIBRE OPTIC CABLE.**

7.14.12.1 This joint is provided in the cable hut for terminating the outdoor fiber optic cable of both the sides, splicing through fibers, connecting fibers to pigtails for connection to optical line terminal equipment etc.

The OFC Cables shall be dressed up on teak wood plank/Aluminum ladder inside cable hut. The armour of the OFC Cable shall be cut before taking the cable in the equipment rack. The cables shall be terminated on OFC termination joint closures. The Optic Fiber termination joint closure as per specification no. TEC TV-210-J-93 (latest) or a proven design approved by RCIL shall be provided in each cable hut to terminate both optical fiber cables and deriving required pigtails. If the contractor intends to supply joint enclosure, which is not as per TEC specification, before starting the supply, contractor shall submit-

- i) The specification of joint enclosure.
- ii) Users certificate regarding its satisfactory performance

At the discretion of the RCIL, contractor will have to demonstrate the working of the joint enclosure. Based on specification, user certificate and demonstration, RCIL, if RCIL finds the design suitable, will grant specific approval to use the joint enclosure. The supply of joint enclosure, which is not of TEC design, shall start only after the approval is received from RCIL. The joint enclosure shall be mounted suitably inside the equipment rack. Two pairs of fibers shall be derived from either side cable at every OFC cable hut through pigtails with FC/PC connectors. The remaining fibers shall be looped through.

7.14.12.2 The procedure for installation of termination joint box depends upon the type of joint enclosure. The installation manual supplied gives the step-by-step procedure for installation. However, the general steps are as under: -

- Marking the cable
- Stripping/cutting the cable
- Gripping cable in sheath/clamp
- Treatment of tension member
- Fiber splicing
- Enclosing fiber
- Fixing strength member
- Closing the cover
- Fixing termination box
- Fixing the cable.

7.14.12.3 **MARKING THE CABLE**

- a) Determine the cable length up to the proposed location of termination box. It is also to be ensured that at least 10 meters of cable is coiled in the cable pit.
- b) Determine the cutting point and mark the cable
- c) Determine the sheath peeling point and mark the cable

7.14.12.4 **CUTTING / STRIPPING THE CABLE**

- a) Cut the cable as per the marking.
- b) Remove the sheath from cable ends. During sheath stripping care should be taken not to damage the fibers.
- c) The length and the steps for various sheath cutting shall be as per the instruction given in the manual.

7.14.12.5 **GRIPPING THE CABLE**

- a) Wind PVC tape around the cable core just beside edge of the sheath.
- b) Insert the bushing inside sheath by cutting the cable sheath for about 25 mm.
- c) Place the sheath grip (lower half and upper half) and tighten it with the help of torque wrench.

7.14.12.6 **FIXING OF TENSION MEMBER**

- a) Mark the tension member for the specified length and cut it.
- b) Clean the tension member thoroughly by Alcohol and cotton cloth.
- c) Fix tension member holder with the help of instant adhesive at the end of tension member.

7.14.12.7 **FIBRE SPLICING**

The procedure for splicing is same as described for straight joint closure in Clause 7.14.7 above.

7.14.12.8 **ENCLOSING FIBRES**

- a) Set the fiber cassette on the base.
- b) Arrange excess length of fiber to make double figure of eight.
- c) Enclose the spliced fiber and its excess length carefully.
- d) Repeat the procedure for other fibers.
- e) After this, the box can be closed. However, a packet of silica gel may be placed inside for protection from entry of moisture.

7.14.12.9 MOUNTING OF TERMINATION BOX.

Termination box can be fixed either on wall or on equipment rack. At wayside stations it shall be mounted inside the equipment rack in order to prevent pigtailed from rodent attacks.

- a) Mark the fixing holes on the walls/bracket/frame
- b) Place the termination box and tightened the nuts inside the base box.
- c) Put the covers.

7.14.12.10 FIXING THE CABLE

Secure the cable on wall/frame at two places within one meter from termination box keeping in view straight entry of cable in termination box.

7.15 ISOLATION OF ARMOUR OF OFC CABLE

The maximum continuous length of armour of OFC Cable should not exceed 1.6 Kms. in order to keep the induced voltage within permissible limits. Where the continuous length of cable exceeds 1.6 Kms. a 50 mm cut shall be made in the armour after every 1.6 Kms. The Exposed cable at the cut shall be covered by shrinking suitable heat shrink sleeve as per TEC specifications.

7.16 ACCEPTANCE TEST FOR FIBRE OPTIC CABLE

The Procedure for Testing of Fiber Optic Cable shall be jointly finalized by Contractor with Engineer of the RCIL. The Parameters in the concerned specification shall be taken as reference. The Test shall be conducted from cable hut to cable hut, after the Splicing & termination Joints are completed. The length of cable (as per marking in cable & as measured by OTDR) loss in cable, average loss per Km., No. of Splices, Splice loss, etc. shall be recorded and jointly signed as per pro-forma given in Para 7.17 below.

7.17 TEST PROTOCOL FOR OPTICAL FIBRE CABLE

SYSTEM TEST PROTOCOL TEST	OPTICAL FIBRE CABLE	FIELD

Route: -----		Date: -----
Station: -----		No. of mid- Section splices: -----

Section: -----		Measured by:-----
Length (by OTDR): -----		Length as per meter marking on cable sheath -----

7.18

TOOLS AND EQUIPMENTS REQUIRED FOR JOINTING AND TERMINATION OF FIBRE OPTIC CABLE.

S. No.	Tool's Name
1	Branch Joint Closure
2	Termination Box
3.	Rubber end Block
4.	Sheath Clamp
5.	Bushing
6.	Strength Member holder
7.	Heat Shrinkage tube
8.	Arc fusion splicer machine.
9.	Power cord AC/DC
10.	Walkie-Talkie 12V DC source
11.	Tube heater
12.	Precision cleaver
13.	Cable sheath stripper
14.	Fiber stripper
15.	Knife for HDPE cutting
16.	Hexa for strength membrane
17.	Isopropyl alcohol or methanol of high specific gravity
18.	Johnson Buds
19.	Tweezers
20.	Gun heater Blower type
21.	Sleeve for splice protection
22.	O.T. D.R.
23.	Stickers for numbering of splicers
24.	Portable k. oil generator
25.	Umbrella's 2 Nos.
26.	Dust protection for splicing machine.

Note: -Wherever cable has to be coiled/looped, the diameter of the coil/loop shall be greater than 30 times the diameter of the cable.

रेलटेल
RAILTEL

A Government of India
Undertaking

Annexure –III

1) Automated Optical Fiber Fusion Splicing Machine

Along with following accessories :

Sr.No.	Description	Quantity (Nos.)
a.	High Precision Swift Fiber Cleaver	1
b.	Spare Electrodes	1
c.	Electrode Sharpener	1
d.	AC Power Cord with 3 pin Plug for Splicing machine	1
e.	Battery Pack	1
f.	Fiber Stripper	1
g.	Splice Protection Sleeve	100
h.	Shoulder Strap	1
i.	Switching Power Adapter	1
j.	Battery Charger	1
k.	Operational and software Manual	1
l.	Carrying Case	1
m.	Tool kit	1
n.	1Km OFC (G652D) spool (corning make)	1

2) OTDR (Optical Time Domain Reflectometer)

Along with following accessories :

- a) FC Universal Adapter
- b) Power Cord
- c) Battery In-built
- d) Charger Adapter
- e) Operation Manual
- f) Carrying case

3) Advance cable and fault locator electronic type

- a. Direct-Connect Transmitter Cable
- b. Ground Rod; stainless steel
- c. Earth Contact Frame
- d. Earth Contact Frame cable; 1.2 m (4 ft.) long
- e. Coupler Kit; consists of 3" Coupler for use on cables up to 7.6 cm (3"), Coupler Extension Cable, and Pouch
- f. 1" Coupler; for use on cables up to 2.5 cm (1") in diameter
- g. 6" Coupler; for use on cables up to 17.5 cm (6.9") in diameter; with pouch
- h. Inductive Probe; for pair identification.
- i. Coupler Extension Cable
- j. Probe Cable
- k. Ground Extension Cable
- l. Active Duct Probe

Figure 1

HDPE END CAPS

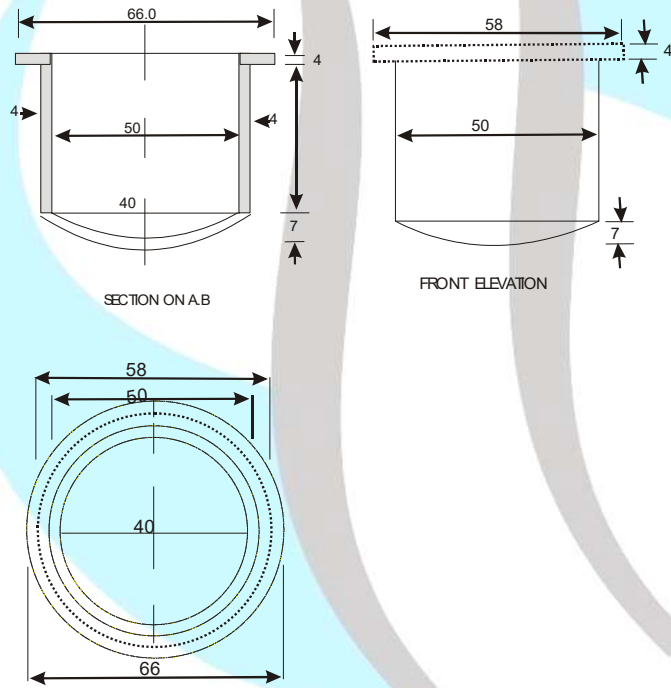

रेलटेल
RAILTEL

A Government of India
Undertaking

Figure 2

Rubber Cork

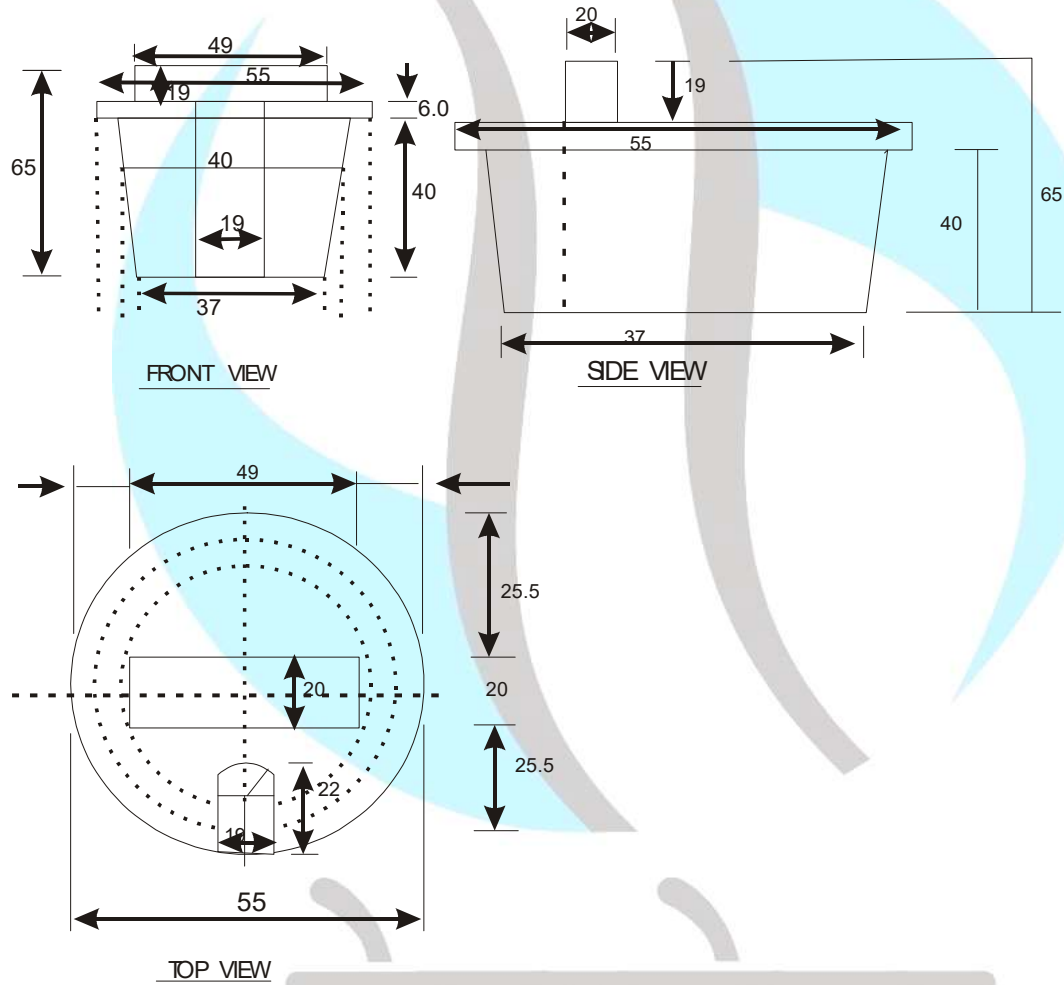

NOTE:

1. ALL DIMENSIONS ARE IN MM.
2. DIMENSIONS ARE ONLY FOR GUIDENCE. TAPPER SHOULD BE SUCH THAT IT SHOULD TIGHTLY FIX. INTO TYPE A & TYPE B HOPE 50 mm OO PIPES.

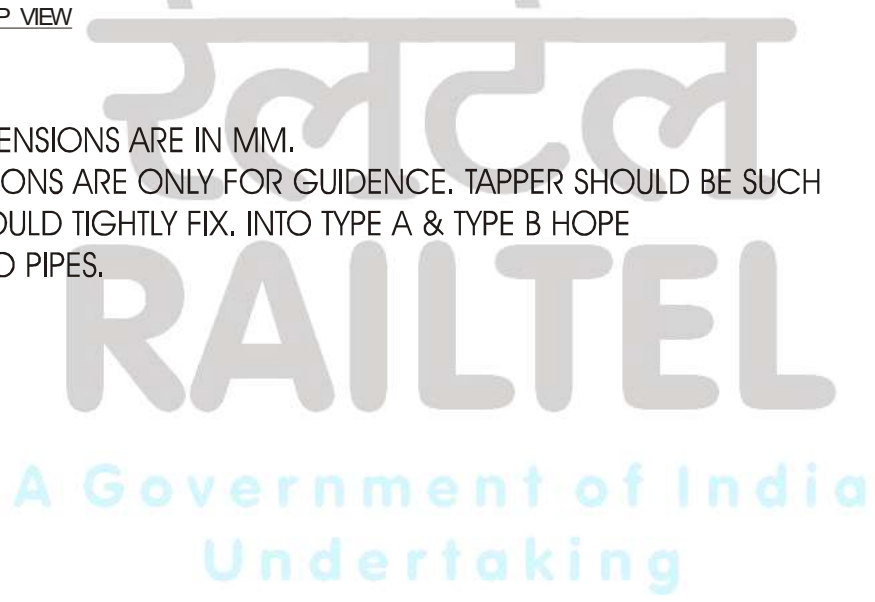

CHAPTER-8

List of Addresses for Specification

8.0 Address from where specification copy can be purchased: The copy of IRS, RDSO, TEC and BIS specification used in the tender documents can be purchased from following sources.

8.1 IRS Specification:

- i) Manager Publications, Government of India
Civil Lines, New Delhi- 110054
- ii) Government of India Book Depot,
8 - S.K. Roy Road, Calcutta – 700001

8.2 RDSO Specification:

- i) RDSO, Manak Nagar, Lucknow

8.3 DOT/TEC/ITD Specification:

- i) Khurshid LalBhavan, Janpath, New Delhi- 110001

8.4 B.I.S. Specification:

- i) Directorate General, Indian Standards Institution,
9- Bahadur Shah Zafar Marg, New Delhi -110002
- ii) F- block, Unity Building, Narsimhrajra Square, Bangalore- 560002
- iii) 534- SardarVallabhBhai Patel Road, Mumbai.
- iv) 5- Chowringhee Approach, PO Princep street, Calcutta- 700072
- v) Ahinsa Building (1st floor), SCO 82-83, Sector 27-C, Chandigarh- 160017
- vi) 5-8-56/57, L.N. Gupta Marg, Hyderabad- 208005.
- vii) 117/418-B, Sarvoday Nagar, Kanpur – 208005
- viii) C.I.T. Campus, Adyar, Madras – 600020.

CHAPTER-9

DRAWINGS

SN	Drg. No.	Drawing descriptions
1	RailTel/WR/OT/DFC/001	TRENCHING IN NON ROCKY SOIL ALONG RAILWAY TRACK AT 1.2 MTR DEPTH
2	RailTel/WR/OT/DFC/004	TRENCHING IN ROCKY SOIL ALONG RAILWAY TRACK AT 1.0 MTR DEPTH
3	RailTel/WR/OT/DFC/005	TRENCHING IN ROCKY SOIL ALONG RAILWAY TRACK AT 1.0 MTR to 0.5 MTR DEPTH
4	RAILTEL/WR/OT/DFC/006(a)	ARRANGEMENT OF CABLE ON GRIDER BRIDGES
5	RAILTEL/WR/OT/DFC/006(b)	ARRANGEMENT OF CABLE ON SLOPE OF GRIDER BRIDGES
6	RAILTEL/WR/OT/DFC/007	LAYING OF CABLE OVER RCC CULVERTS
7	RAILTEL/WR/OT/DFC/008	LAYING OF CABLE BELOW RCC CULVERTS
8	RAILTEL/WR/OT/DFC/009	LAYING OF CABLE BY TRACK CROSSING
9	RAILTEL/WR/OT/DFC/010	ARRANGEMENT OF DWC PIPES TRUNKING UNDER METAL ROADS, LC GATE
10	RAILTEL/WR/OT/DFC/011	PROVISION OF RCC CHAMBER FOR CARRYING OF OFC LOOP/JOINT
11	RAILTEL/WR/OT/DFC/012	PROVISION OF ROUTE MARKERS ALONG THE RAILTEL'S OFC ROUTE
12	RAILTEL/WR/OT/DFC/013	ARRANGEMENT OF CABLE OVER ARCH BRIDGES
13	RAILTEL/WR/OT/DFC/014	ARRANGEMENT OF CABLE IN BUILDINGS /CABIN ENTRY
14	RAILTEL/WR/OT/DFC/015	PROTECTION METHOD AFTER LAYING OF DWC/PDRC PIPE IN MANUAL BOARING
15	RAILTEL/WR/OT/DFC/016	METHOD OF SHORTING, EXCAVATING TRENCH FOR OFC
16	RailTel/WR/3.13/OT/NKN/Zone	BUILDING ENTRY OF DUCT WITH OR WITHOUT PROTECTION

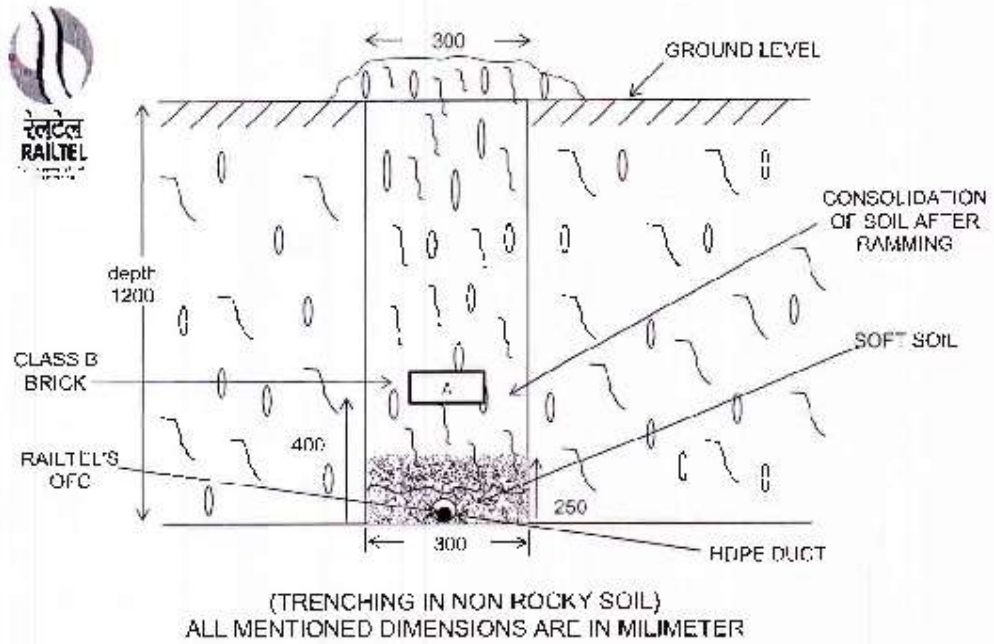

Note

1. if the depth cannot be achieved then the payment will be made as per clause 5.18.
- A-Only in station limit (UP distant signal to DN distant signal) ;
 Brick (class B) shall be provided .

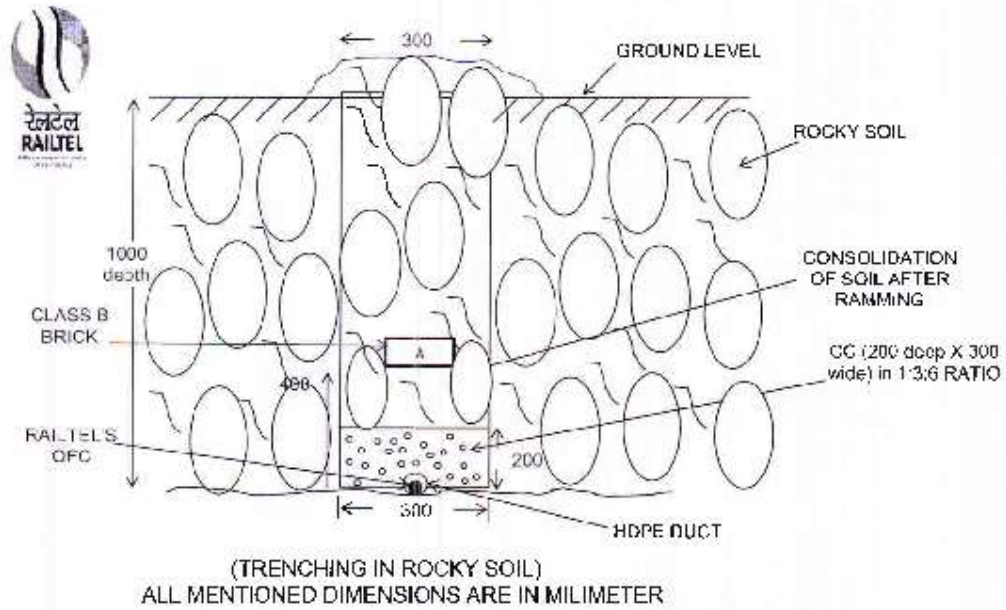

RAILTEL CORPORATION OF INDIA LTD.DRG NO. RAILTEL/WR/OT/OFC/001		
Description: TRENCHING IN NON ROCKY SOIL ALONG RAILWAY TRACK		
 MGR/PROJ/RCL/MUM (DRAWN)	 ASM/PROJ/RCL/MUM (CHECK)	 GM/PROJ/RCL/MUM (APPROVED)

A Government of India
 Undertaking



Note .

1. if the depth cannot be achieved ,then the payment will be made as per clause 5.16.
- A-Only in station limit (UF distant signal to DN distant signal) ,
 Brick (class B) shall be provided .

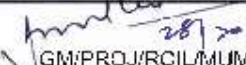
RAILTEL CORPORATION OF INDIA LTD.DRG NO. RAILTEL/WR/OT/DFC/104		
Description: TRENCHING IN ROCKY SOIL ALONG RAILWAY TRACK .		
 MGR/PROJ/RCIL/MJM (DRAWN)	 AGM/PROJ/RCIL/MJM (CHECK)	 GM/PROJ/RCIL/MJM (APPROVED)

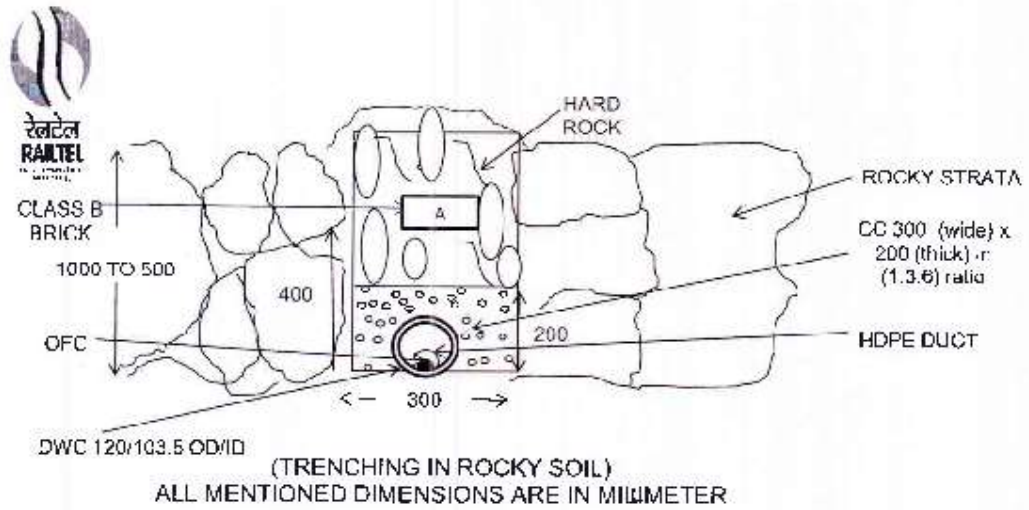

Note .

1. if the depth cannot be achieved ,then the payment will be made as per clause 5.18.
- A-Only in station limit (UP distant signal to DN distant signal) .
 Brick (class B) shall be provided .

RAIL TEL CORPORATION OF INDIA LTD.DRG NO. RAILTELWR/OT/DFC/005		
Description: TRENCHING IN ROCKY SOIL ALONG RAILWAY TRACK ~		
 MGR/PROJ/RCIL/MUM (DRAWN)	 AGM/PROJ/RCIL/MUM (CHECK)	 GM/PROJ/RCIL/MUM (APPROVED)

A Government of India
 Undertaking

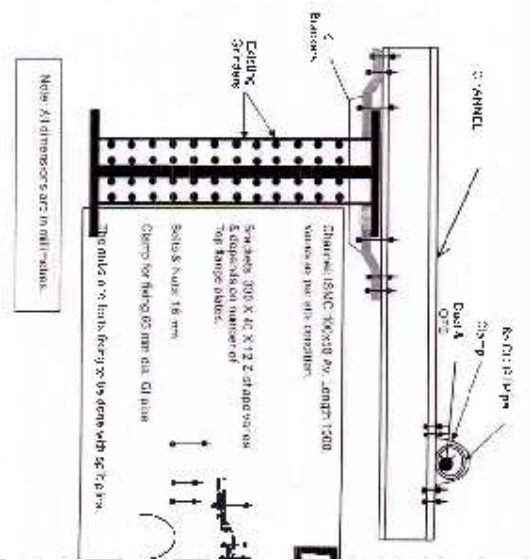
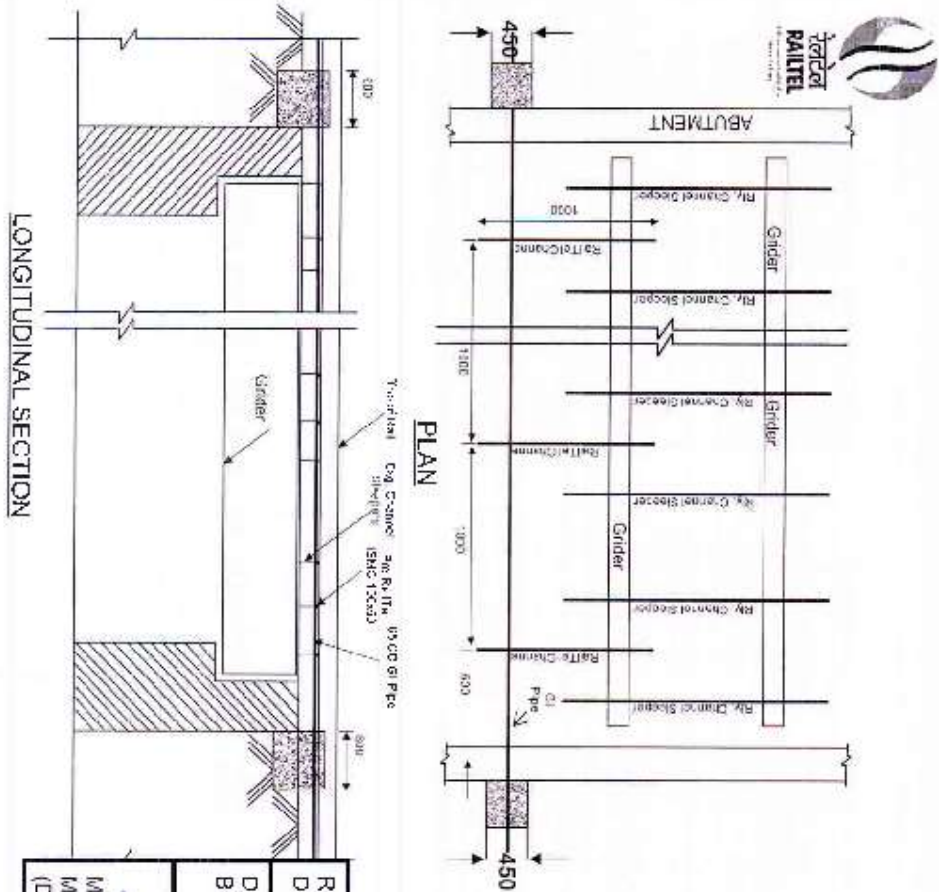

RAIL TEL CORPORATION OF INDIA LTD.
 DRG NO. RAILTEL/WR/OT/DFC/006(a)

Description: ARRANGEMENT OF CABLE ON GIRDER BRIDGES

MGR/PROJ/RCL/ MUM. (DRAWN)	AGM/PROJ/RCL/ MUM. (CHECK)	GM/PROJ/RCL/ MUM. (APPROVED)
----------------------------	----------------------------	------------------------------

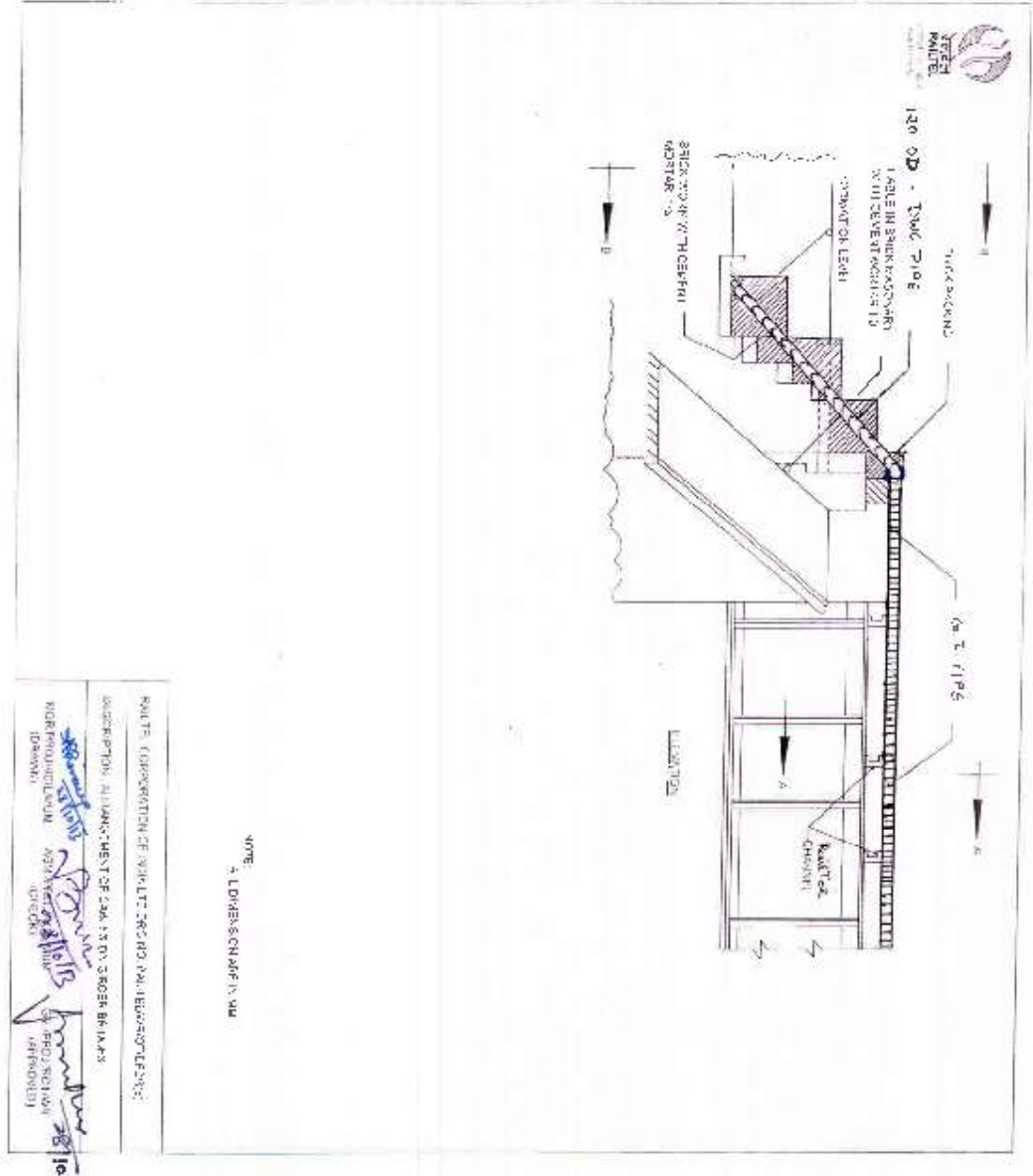

A Government of India
 Undertaking

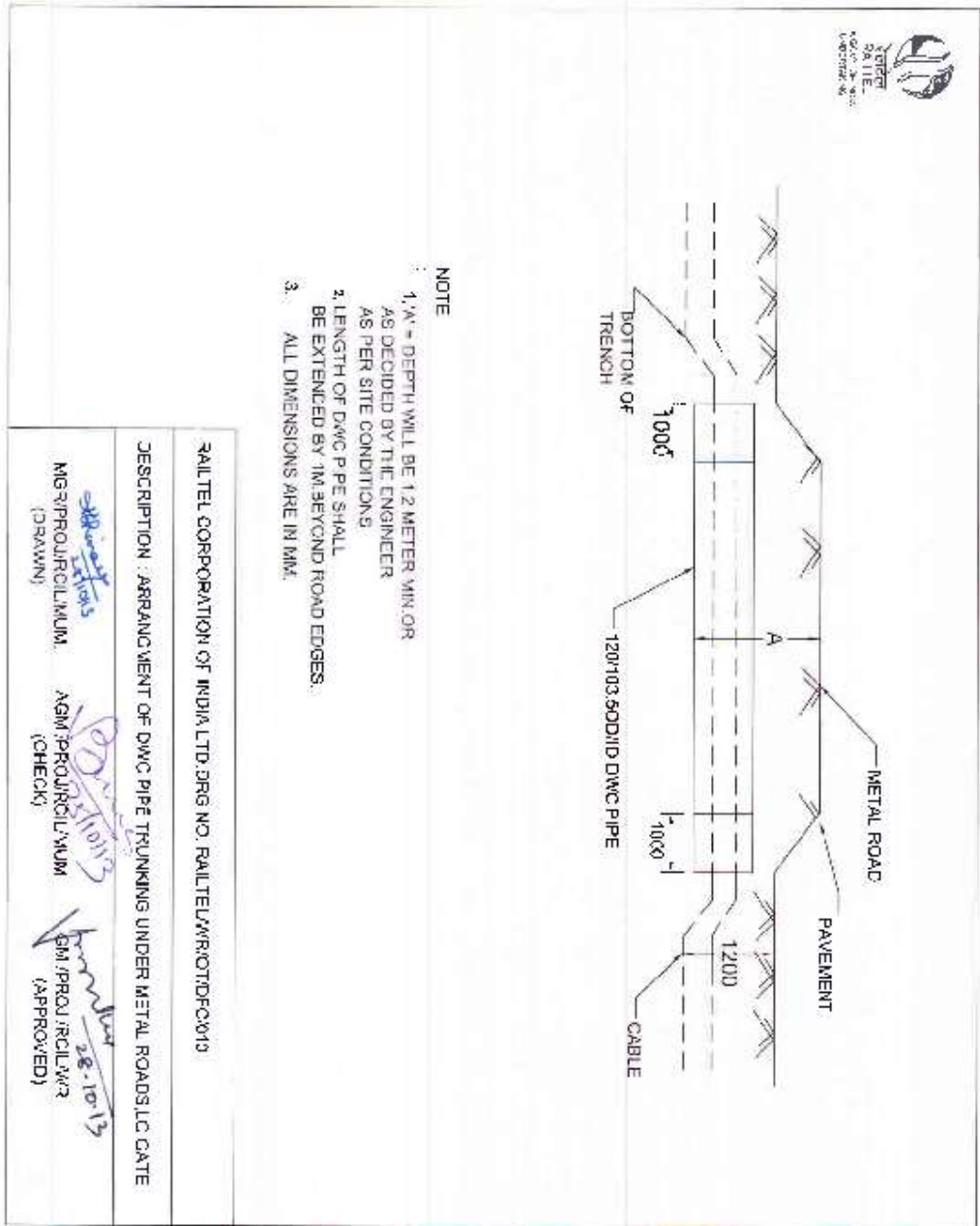

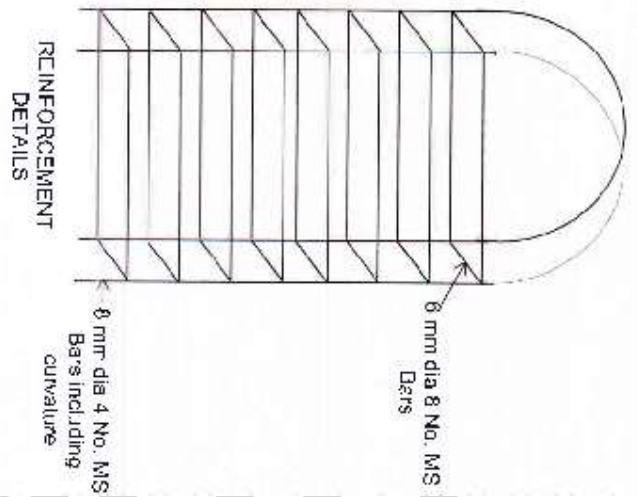
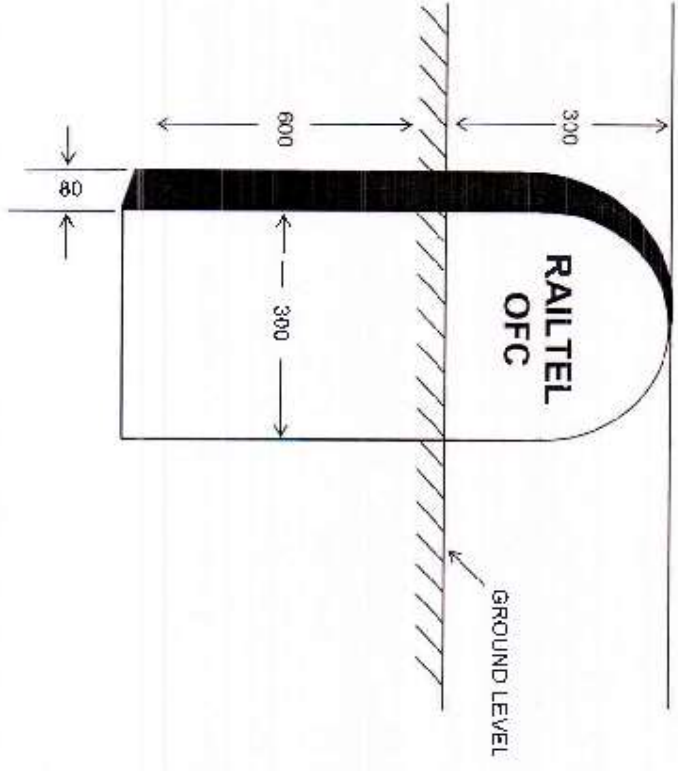

RCC CABLE ROUTE MARKER

1. Painted with orange colour.
2. Painted with green colour at chambers
3. In rocky area concreting must be done.
4. Concreting shall be in 1:2:4 ratio and tested with N_p 2 standard.
5. All dimensions are in mm.

RAILTEL CORPORATION OF INDIA LTD. DRG NO. RAILTEL/WR/OT/DFC/012	
DESCRIPTION: DETAILS OF ROUTE MARKER ALONG THE RAILTEL'S OFC ROUTE	
Mr./Proj./RCL/Mum. (DRAWN)	AGM/Proj./RCL/Mum (CHECK)
Mr./Proj./RCL/Mum. (APPROVED)	GM/Proj./RCL/Mum (APPROVED)

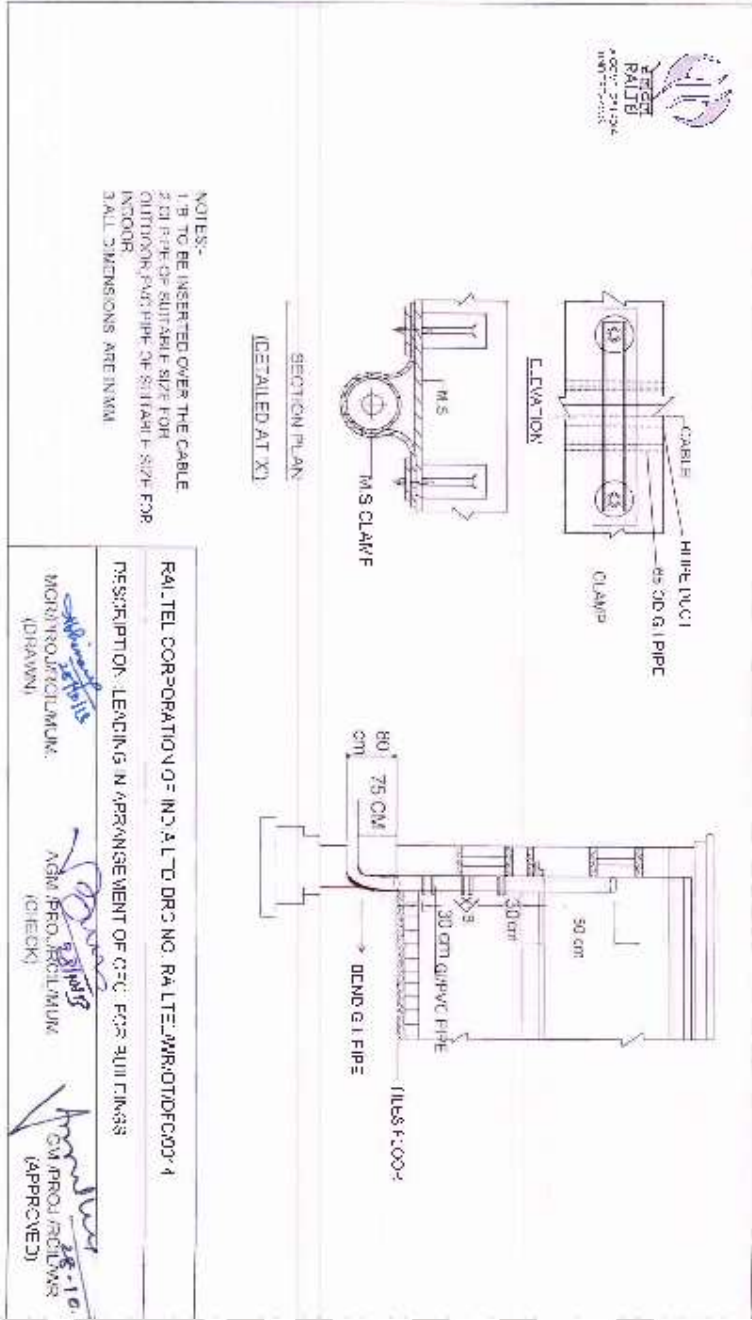



MANUAL BORING

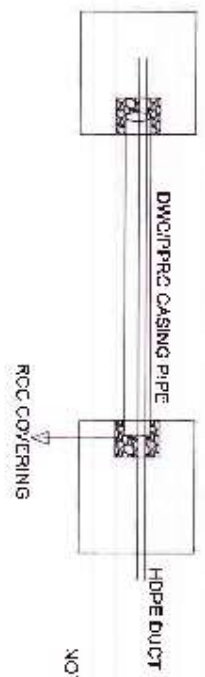
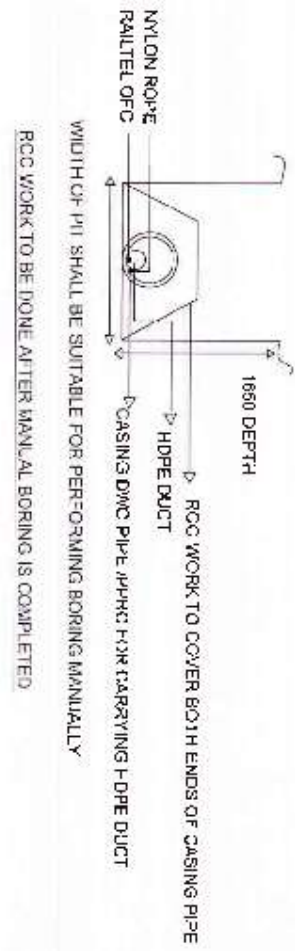

NOTE:
ALL DIMENSION ARE IN MM

RAILTEL CORPORATION OF INDIA LID DRG NO. RAILTEL/PROT/DFC/015		
DESCRIPTION: PROTECTION METHOD AFTER LAYING OF DMC/PPRC PIPE IN MANUAL BORING		
MR. PROJ. CL. MUM. (DRAWN)	MR. S. S. S. S. S. MR. S. S. S. S. S. (CHECK)	MR. S. S. S. S. S. MR. S. S. S. S. S. (APPROVER)

DRG NO. RailTel/WR/OT/OFC/01B.

ANNEXURE 3.5

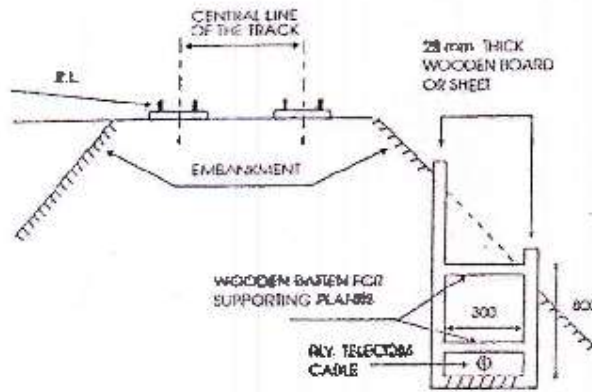

TRUE COPY

SBE/P/S D/GORE/ALD

NOTE :
1. DIMENSIONS ARE IN MILLIMETER

DATE	BY	CHKD	METHOD OF SHORTING EXCAVATING TRENCH FOR CABLE	R.D.S.O./TC/35003
	BY (DATE)	CHKD		
	SS/E/T	CTI	R.D.S.O.	DL
	AS/E/T	K. L. JOSHI COMP		NOT TO SCALE

A Government of India
Undertaking

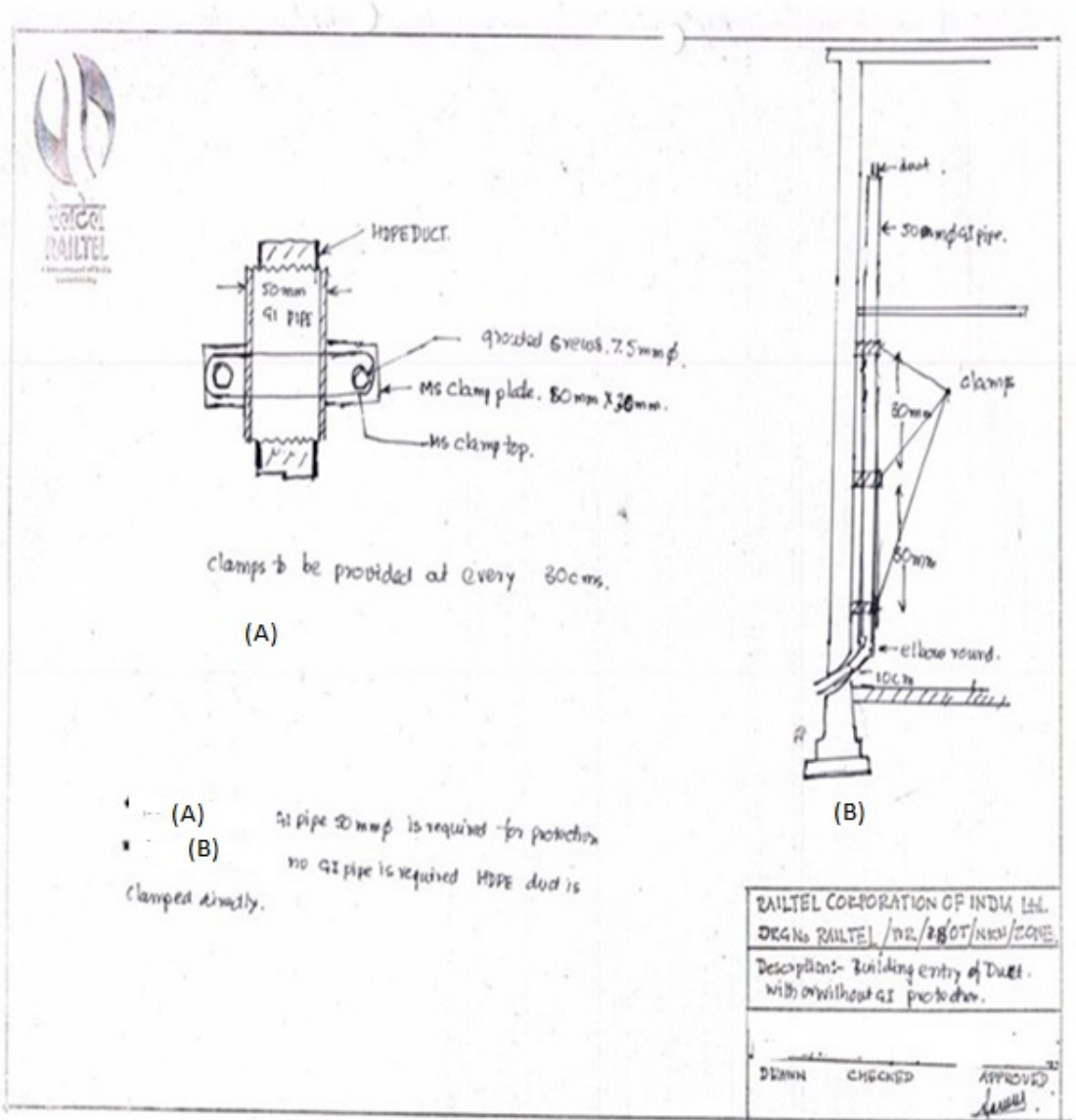

RAILTEL

A Government of India
 Undertaking

CHAPTER- 2

Schedule of Requirement

Name of Work: Supply, Installation, Trenching/HDD/Clamping, Laying of Duct, Blowing of OFC through Ducts, Splicing, Testing & Commissioning for OFC Patch Replacement at various sections of Mumbai Territory of Western Region.

SOR: Mumbai Territory					
Item Description	No. of Sections	Unit	Qty	Rate (Rs)/ unit	Total Amount (Rs.)
Excavation of Trenches/HDD, Supply & Laying of Duct with Accessories and OFC with Accessories, Testing and Commissioning of OFC Patches as per technical specifications (Chapter-7) given in the Tender Document.	8	Mtr	61200	375.42	22975704
Cost of Schedule (Rs.)					22975704

NOTE: - All items should be read along with detailed specification / drawing/ explanatory note / site conditions etc.

1. It is certified that I/we have inspected the site of work and acquainted myself / ourselves with local conditions.
2. I/we have carefully gone through the specifications, given in tender document and understood.

Signature of Tenderer

RAILTEL
A Government of India

END OF DOCUMENT
